

Evaluation of Current Stormwater Design Criteria within the State of Florida

Final Report

Prepared for:



**FLORIDA DEPARTMENT OF
ENVIRONMENTAL PROTECTION**

FDEP Contract No. SO108

June 2007

Prepared By:

Harvey H. Harper, Ph.D., P.E.
David M. Baker, P.E.

Environmental Research & Design, Inc.

3419 Trentwood Blvd., Suite 102
Orlando, FL 32812

ACKNOWLEDGEMENTS

The authors wish to thank the Bureau of Watershed Management/Nonpoint Source Management of the Florida Department of Environmental Protection for their assistance in funding and administration of this project. A special thank you is also given to the FDEP Project Manager, Mr. Eric Livingston, for his invaluable support throughout this project. His guidance, technical expertise, and wisdom contributed heavily to the success of this project. The authors also wish to thank the talented personnel from the various water management districts who reviewed the Draft Final Report and provided valuable comments and input.

Funding for this project was provided by a TMDL Water Quality Grant from the Bureau of Watershed Management, Florida Department of Environmental Protection, Tallahassee, Florida.

TABLE OF CONTENTS

<u>Section</u>	<u>Page</u>
LIST OF TABLES	LT-1
LIST OF FIGURES	LF-1
1. INTRODUCTION	1-1
1.1 Scope of Work	1-1
2. REGULATION OF STORMWATER IN FLORIDA	2-1
2.1 State Regulations	2-1
2.2 Water Management Districts	2-3
2.3 Local Governments	2-14
3. PRECIPITATION CHARACTERISTICS IN FLORIDA	3-1
3.1 Annual and Regional Precipitation	3-1
3.2 Rainfall Event Characteristics	3-6
3.3 Antecedent Dry Period	3-9
4. STORMWATER RUNOFF - QUALITY AND QUANTITY	4-1
4.1 Water Quality Characteristics	4-1
4.1.1 Data Availability	4-1
4.1.2 Single-Family Residential	4-11
4.1.3 Multi-Family Residential	4-14
4.1.4 Low-Density Residential (Rural)	4-15
4.1.5 Low-Intensity Commercial Areas	4-16
4.1.6 High-Intensity Commercial Areas	4-17
4.1.7 Light Industrial	4-17
4.1.8 Highway/Transportation	4-18
4.1.9 Agricultural Areas	4-19
4.1.9.1 Pasture Land Use	4-20
4.1.9.2 Citrus Land Use	4-21
4.1.9.3 Row Crops Land Use	4-21
4.1.9.4 Comparison of Agricultural Characteristics	4-22

TABLE OF CONTENTS – CONTINUED

4.1.10	Undeveloped/Rangeland/Forest Land	4-23
4.1.11	Mining/Extractive Land Use	4-24
4.1.12	Wetlands	4-24
4.1.13	Open Water/Lakes	4-25
4.1.14	Recommended Characterization Data	4-25
4.2	Estimation of Runoff Quantities	4-27
4.2.1	Methodology	4-27
4.2.2	Impacts of Rainfall Distributions on Runoff Depth	4-34
4.2.3	Annual Runoff Generation	4-40
5.	PERFORMANCE EFFICIENCY OF STORMWATER MANAGEMENT SYSTEMS	5-1
5.1	Literature-Based Removal Efficiencies for Typical Stormwater Treatment Systems	5-2
5.1.1	Dry Retention Systems	5-2
5.1.2	Wet Detention Systems	5-6
5.1.3	Dry Detention (With and Without Filtration/Underdrain)	5-10
5.1.4	Off-line Retention/Detention (Dual Pond) Systems	5-13
5.1.5	Comparison of Treatment Efficiencies for Typical Stormwater Management Systems	5-15
5.2	Performance Efficiency of Existing Stormwater Design Criteria	5-16
5.2.1	Dry Retention	5-16
5.2.1.1	Evaluation Methodology	5-17
5.2.1.2	Design Criteria Based on Runoff Depth	5-18
5.2.1.3	Design Criteria Based on Runoff from a Specified Rainfall Event	5-26
5.2.2	Wet Detention	5-33
5.2.2.1	SJRWMD Design Criteria	5-35
5.2.2.2	SFWMD Design Criteria	5-35
5.2.3	Dry Detention	5-40
6.	RECOMMENDED MODIFICATIONS TO EXISTING STORMWATER DESIGN CRITERIA	6-1
6.1	Design Criteria to Achieve 80% Removal	6-3
6.1.1	Dry Retention	6-3
6.1.2	Wet Detention	6-14
6.2	Design Criteria to Achieve 95% Removal	6-16
6.2.1	Dry Retention	6-16
6.2.2	Wet Detention	6-16

TABLE OF CONTENTS – CONTINUED

6.3	Design Criteria to Achieve Post-Development Less Than or Equal To Pre-Developing Loadings	6-24
6.3.1	Estimation of Pre-Development Pollutant Loadings	6-24
6.3.2	Estimation of Post-Development Pollutant Loadings	6-26
6.3.3	Estimated Annual Removal Efficiencies	6-29
6.4	Evaluation of Wet Detention Pond Depth	6-35
6.4.1	Theory of Shallow vs. Deep Ponds	6-35
6.4.2	Zonation and Stratification	6-44
7.	DESIGN EXAMPLES	7-1
7.1	Design Example #1	7-1
7.2	Design Example #2	7-17
7.3	Design Example #3	7-29
7.4	Conclusions	7-53
	7.4.1 Dry Retention	7-53
	7.4.2 Wet Detention	7-55
7.5	Summary	7-57
8.	REFERENCES	8-1

Appendices

- A. Precipitation Data
- B. Hydrologic Characteristics from Selected Stormwater Land Use Characterization Studies
- C. Calculated Annual Runoff Coefficients for the Designated Meteorological Zones as a Function of Curve Number and DCIA
- D. Calculated Performance Efficiency of Dry Retention as a Function of DCIA and non-DCIA Curve Number

LIST OF TABLES

<u>Number</u>		<u>Page</u>
2-1	Stormwater System Design Standards Outlined in Chapter 62-25 FAC	2-4
2-2	Comparison of Stormwater Management System Design Criteria for Water Management Districts in Florida	2-7
3-1	Characteristics of Selected Meteorological Sites in Florida	3-5
3-2	Percentage of Annual Rain Events Occurring in Selected Event Intervals	3-8
3-3	Mean Antecedent Dry Periods for Rain Events at the Designated Regional Sites	3-10
4-1	General Land Use Categories for Runoff Characterization Data	4-2
4-2	Runoff Characterization Data Availability	4-3
4-3	Summary of Selected Stormwater Characterization Studies Performed in the State of Florida	4-5
4-4	Summary of Mean Stormwater Characteristics from Single-Family Residential Stormwater Studies	4-12
4-5	Comparison of Runoff Characteristics for Residential Areas Utilizing Grassed Swales and Curb/Gutter Drainage Systems	4-14
4-6	Summary of Mean Stormwater Characteristics from Multi-Family Residential Stormwater Studies	4-15
4-7	Summary of Mean Stormwater Characteristics from Low-Intensity Commercial Stormwater Studies	4-16
4-8	Summary of Mean Stormwater Characteristics from High-Intensity Commercial Stormwater Studies	4-17
4-9	Summary of Mean Stormwater Characteristics from Light Industrial Stormwater Studies	4-18
4-10	Summary of Mean Stormwater Characteristics from Highway/Transportation Stormwater Studies	4-19

LIST OF TABLES – CONTINUED

4-11	Summary of Mean Stormwater Characteristics from Pasture Land Use Stormwater Studies	4-20
4-12	Summary of Mean Stormwater Characteristics from Citrus Land Use Stormwater Studies	4-21
4-13	Summary of Mean Stormwater Characteristics from Row Crop Stormwater Studies	4-22
4-14	Comparison of Stormwater Concentrations from Agricultural Activities in Florida	4-23
4-15	Summary of Mean Stormwater Characteristics from Undeveloped/Rangeland/Forest Stormwater Studies	4-23
4-16	Summary of Mean Stormwater Characteristics from Mining/Extractive Stormwater Studies	4-24
4-17	Summary of Literature-Based Runoff Characterization Data for General Land Use Categories in Florida	4-26
4-18	Characteristics of SCS Hydrologic Soil Group Classifications	4-28
4-19	Listing of NCDC Hourly Precipitation Monitoring Stations in Florida	4-30
4-20	Recommended Seasonal Rainfall Depths for the Three Antecedent Moisture Conditions (AMC)	4-32
4-21	Recommended Curve Number Adjustments Based on Antecedent Moisture Contents	4-33
4-22	Summary of Hydrologic Assumptions Used for Developed Land Use Categories	4-35
4-23	Counties Included in the Designated Meteorological Zones	4-38
4-24	Summary of Mean Runoff Coefficients for Each Cluster as a Function of Land Use and Hydrologic Soil Group	4-39
5-1	Treatment Efficiencies for Dry Retention Systems Based on Selected Research Studies in Florida	5-5
5-2	Treatment Efficiencies for Wet Detention Systems Based on Selected Research Studies in Florida	5-8

LIST OF TABLES – CONTINUED

5-3	Treatment Efficiencies for Dry Detention with Filtration Systems Based on Selected Research Studies in Florida	5-12
5-4	Treatment Efficiencies for Off-Line Retention/Detention Systems (Dual Pond) Based on Selected Research Studies in Florida	5-15
5-5	Estimated Pollutant Removal Efficiencies for Common Stormwater Treatment Facilities	5-15
5-6	Calculated Annual Mass Removal Efficiency of a Dry Retention Pond with a Treatment Volume Equivalent to 0.5-inch of Runoff	5-19
5-7	Calculated Annual Mass Removal Efficiency of a Dry Retention Pond with a Treatment Volume Equivalent to the Runoff from 1 inch of Rainfall	5-28
5-8	Estimated Performance Efficiency of Wet Detention Ponds Designed According to SJRWMD Criteria	5-35
5-9	Summary of Studies Relating Mass Removal of Nitrogen and Phosphorus as a Function of Detention Time in Wet Ponds	5-37
6-1	Required Retention Depths to Achieve an Annual Removal Efficiency of 80%	6-4
6-2	Recommended Design Criteria for Dry Retention Ponds to Achieve 80% Annual Removal Efficiency	6-11
6-3	Recommended Design Criteria for Wet Detention Ponds	6-14
6-4	Required Retention Depths to Achieve an Annual Removal Efficiency of 95%	6-17
6-5	Hydrologic Assumptions for Estimation of Runoff and Mass Loadings from Undeveloped Areas	6-24
6-6	Annual C Values for Undeveloped/Natural Areas	6-25
6-7	Calculated Annual Runoff Depths for Undeveloped/Natural Areas	6-25
6-8	Estimated Annual Mass Loadings of Nitrogen and Phosphorus for Undeveloped/Natural Areas	6-26
6-9	Summary of Hydrologic Assumptions Used for Developed Land Use Categories	6-27
6-10	Summary of Calculated Annual Runoff Coefficients for Typical Developed Land Use Categories	6-28

LIST OF TABLES – CONTINUED

6-11	Summary of Annual Runoff Depths for Typical Developed Land Use Categories	6-30
6-12	Calculated Total Nitrogen Loadings for Typical Developed Land Use Categories	6-31
6-13	Calculated Total Phosphorus Loadings for Typical Developed Land Use Categories	6-32
6-14	Required Removal Efficiencies to Achieve Post-Development Less Than or Equal to Pre-Development Loadings for Total Nitrogen	6-33
6-15	Required Removal Efficiencies to Achieve Post-Development Less Than or Equal to Pre-Development Loadings for Total Phosphorus	6-34
6-16	Regression Statistics for Anoxic Depth Model	6-49
7-1	Comparison of Existing and Required Dry Retention Stormwater Treatment Requirements	7-53
7-2	Comparison of Existing and Required Wet Detention Stormwater Treatment Requirements	7-56

LIST OF FIGURES

<u>Number</u>		<u>Page</u>
2-1	Approximate Boundaries for Water Management Districts in Florida	2-5
3-1	Locations of Meteorological Monitoring Sites	3-2
3-2	Isopleths of Mean Annual Precipitation in Florida from 1971-2000	3-3
3-3	Locations of Selected Meteorological Sites	3-5
3-4	Percentage of Annual Rain Events Les than 1 inch at the Selected Regional Sites	3-7
3-5	Comparison of the Mean Number of Annual Rainfall Events at the Selected Regional Sites	3-9
3-6	Comparison of Dry and Wet Season Antecedent Dry Periods at the Regional Monitoring Sites	3-11
4-1	Locations of Hourly Meteorological Monitoring Sites	4-31
4-2	Percentage of Variance in Annual Runoff Coefficients Explained as a Function of the Number of Clusters	4-36
4-3	Meteorological Zones Identified Using Cluster Analysis	4-37
4-4	General Relationships Between Percent DCIA, Curve Number, and C Value	4-41
4-5	Distribution of C Values as a Function of DCIA and Curve Number for the Panhandle Area (Zone 1)	4-42
4-6	Distribution of C Values as a Function of DCIA and Curve Number for the Florida Keys (Zone 3)	4-44
4-7	State-wide Mean Distribution of C Values as a Function of DCIA and Curve Number	4-45
4-8	Modeled Annual Runoff Coefficients (C Values) for a Hypothetical Development with a DCIA of 40% and a non-DCIA Curve Number of 70	4-46
4-9	Percentage of Annual Rainfall Volume Generated by Rain Events < 0.1 Inch	4-47

LIST OF FIGURES – CONTINUED

4-10	Percentage of Annual Rainfall Volume Generated by Rain Events > 1 Inch	4-47
4-11	Percentage of Annual Rainfall Depth Lost to Initial Abstraction on Impervious Surfaces	4-48
5-1	Schematic of a Dry Retention Facility	5-3
5-2	Schematic of a Wet Detention Facility	5-6
5-3	Schematic of a Dry Detention with Underdrain System	5-10
5-4	Schematic of an Off-line Retention/Detention System	5-14
5-5	Calculated Annual Mass Removal Efficiencies for 0.5-inch of Dry Retention for a Development with 40% DCIA and a non-DCIA Curve Number of 70	5-24
5-6	State-wide Average Removal Efficiencies for 0.5 inch of Dry Retention for Various DCIA Percentages and non-DCIA Curve Numbers	5-25
5-7	Calculated Annual Mass Removal Efficiencies for Dry Retention of the Runoff from 1 inch of Rainfall for a Development with 40% DCIA and a non-DCIA Curve Number of 70	5-27
5-8	Comparison of Annual Mass Removal Efficiencies for Dry Retention Systems Designed for Treatment of 0.5 inch of Runoff or the Runoff from 1 inch of Rainfall	5-33
5-9	Removal Efficiency of Total Phosphorus in Wet Detention Ponds as a Function of Residence Time	5-38
5-10	Removal Efficiency of Total Nitrogen in Wet Detention Ponds as a Function of Residence Time	5-39
6-1	Theoretical Removal of BOD as a Function of Residence Time in a Wet Detention Pond	6-2
6-2	State-wide Average Variations in Required Dry Retention Depth for 80% Removal as a Function of DCIA Percentage and non-DCIA Curve Number	6-10
6-3	Variations in Required Dry Retention Depth to Achieve 80% Removal in the Central Zone Area (Zone 2)	6-12
6-4	Variations in Required Dry Retention Depth to Achieve 80% Removal in the Panhandle Zone Area (Zone 1)	6-13

LIST OF FIGURES – CONTINUED

6-5	Variations in Required Dry Retention Depth to Achieve 95% Removal on a State-wide Basis	6-23
6-6	Comparison of Estimated Annual Mass Removal Efficiencies to Achieve Post-Development \leq Pre-Development Loadings of Nitrogen and Phosphorus for a Low-Density Residential Development	6-36
6-7	Comparison of Estimated Annual Mass Removal Efficiencies to Achieve Post-Development \leq Pre-Development Loadings of Nitrogen and Phosphorus for a Single-Family (25% Impervious) Residential Development	6-37
6-8	Comparison of Estimated Annual Mass Removal Efficiencies to Achieve Post-Development \leq Pre-Development Loadings of Nitrogen and Phosphorus for a Single-Family (40% Impervious) Residential Development	6-38
6-9	Comparison of Estimated Annual Mass Removal Efficiencies to Achieve Post-Development \leq Pre-Development Loadings of Nitrogen and Phosphorus for a Multi-Family Residential Development	6-39
6-10	Comparison of Estimated Annual Mass Removal Efficiencies to Achieve Post-Development \leq Pre-Development Loadings of Nitrogen and Phosphorus for a Commercial Development	6-40
6-11	Comparison of Estimated Annual Mass Removal Efficiencies to Achieve Post-Development \leq Pre-Development Loadings of Nitrogen and Phosphorus for a Highway (50% Impervious) Development	6-41
6-12	Comparison of Estimated Annual Mass Removal Efficiencies to Achieve Post-Development \leq Pre-Development Loadings of Nitrogen and Phosphorus for a Highway (75% Impervious) Development	6-42
6-13	Typical Zonation in a Lake or Pond	6-44
6-14	Relationship Between Secchi Disk Depth and Chlorophyll-a for Florida Lakes	6-47

SECTION 1

INTRODUCTION

The discharge of stormwater within the State of Florida has been subject to regulation since the early 1980s to prevent pollution of Waters of the State and to protect the designated beneficial uses of surface waters. Currently, stormwater management is regulated at the State level by the Florida Department of Environmental Protection (FDEP), at the regional level by water management districts, and at the local level by local governments.

The goals for stormwater management within the State of Florida are outlined in Chapter 62-40 of the Florida Administrative Code (FAC), titled “Water Resource Implementation Rule”. This rule establishes that stormwater design criteria adopted by FDEP and the water management districts shall achieve at least 80% reduction of the average annual load of pollutants that cause or contribute to violations of State Water Quality Standards. When the stormwater system discharges to an Outstanding Florida Water (OFW), the design and performance criteria increases to 95% reduction.

A wide range of stormwater design criteria have been implemented within the State of Florida to achieve these minimum stormwater treatment performance standards. However, recent research on the performance efficiency of current stormwater management systems indicates a high degree of variability in the pollutant removal effectiveness of commonly used systems. In addition, stormwater design criteria for the same type of stormwater management system vary widely throughout the State of Florida, which can impact the performance efficiency of stormwater management systems designed in one area compared to another.

1.1 Scope of Work

This report provides a discussion of work efforts performed by Environmental Research & Design, Inc. (ERD) for the Florida Department of Environmental Protection (FDEP) as part of Agreement SO108, titled “Evaluation of Current Stormwater Design Criteria within the State of Florida”. The primary objective of this project is to evaluate current stormwater design criteria within the State of Florida and determine if these criteria meet the treatment requirements specified in Chapter 62-40 FAC. If elements of existing stormwater design criteria fail to meet the requirements of Chapter 62-40 FAC, then changes will be recommended to the current rules to improve stormwater management so that the minimum treatment requirements can be achieved. This analysis was also conducted to evaluate existing design criteria for discharges to OFWs which have the goal of 95% pollutant removal. In addition, an evaluation was also performed to quantify stormwater design criteria necessary to achieve a condition of no net increase in loadings for a project site under post-development conditions compared with loadings discharging from the site under pre-development conditions.

The analyses summarized in this report are based primarily upon mass loadings of nitrogen and phosphorus. Although other constituents are commonly present in stormwater runoff, such as suspended solids, BOD, and heavy metals, nutrients are the most significant parameters linked to water quality impairment within the State of Florida today. Other significant pollutants can often be removed from stormwater more easily than nutrients, and as a result, design criteria which provide the desired removal efficiencies for nutrients will likely achieve equal or better removal efficiencies for other constituents.

The specific objectives of this project are to:

1. Collect and review current stormwater quality design criteria within the State of Florida developed by FDEP and the various water management districts
2. Collect and review stormwater characterization data to update existing databases
3. Identify significant meteorological regions within the State of Florida and develop regionally-specific rainfall and runoff characteristics and relationships
4. Estimate pre-development hydrologic and pollutant loading characteristics for natural areas
5. Collect and review stormwater treatment system performance efficiency information based on previous research performed within the State of Florida
6. Perform model simulations of the anticipated treatment system performance efficiency of common stormwater management systems utilized within the State of Florida based on regional meteorological and hydrologic conditions
7. Evaluate changes to current stormwater regulations, if necessary, to meet the requirements of Chapter 62-40 FAC (80% and 95% pollutant removal efficiencies) and to achieve a condition of no net increase in pollutant loadings following development

This report is divided into eight separate sections for presentation and discussion of the analyses and results of this project. The first section provides an introduction to the report, along with a summary of work efforts performed by ERD. A discussion of stormwater regulations within the State of Florida is given in Section 2. Annual and regional precipitation characteristics in Florida are discussed in Section 3. Section 4 contains an analysis and discussion of the quantity and quality of stormwater runoff generated from various land use categories within the State of Florida. A discussion of the performance efficiency of existing stormwater management practices is given in Section 5. Proposed modifications to existing stormwater management design criteria are given in Section 6. Design examples, which illustrate the proposed design changes, are given in Section 7. Cited references are included in Section 8. Appendices are also attached which contain supporting data and calculations utilized to generate the results and conclusions presented in this report.

SECTION 2

**REGULATION OF
STORMWATER IN FLORIDA**

Since the early 1980s, the discharge of stormwater within the State of Florida has been subject to regulation to prevent pollution of Waters of the State and to protect the designated beneficial uses of surface waters. Currently, the design, permitting, construction, and operation of stormwater management systems within the State of Florida are governed by laws and regulations of the State of Florida, regional water management districts, and local governments. A discussion of existing regulations governing stormwater discharge within Florida is given in the following sections.

2.1 State Regulations

The goals for stormwater management within the State of Florida are outlined in Chapter 62-40 of the Florida Administrative Code (FAC), titled “Water Resource Implementation Rule”. This rule provides general guidelines related to water use and reuse, water transfer, water quality, surface water management, flood protection, and minimum flows and levels. Specific goals related to stormwater management are outlined in Section 62-40.431, titled “Stormwater Management Program”. Paragraph 2a establishes the primary goals of the State Stormwater Management Program:

"The primary goals of the State Stormwater Management Program are to maintain, to the maximum extent practicable, during and after construction and development, the pre-development stormwater characteristics of the site; to reduce stream channel erosion, pollution, siltation, sedimentation, and flooding; to reduce stormwater pollutant loadings discharged to waters to preserve or restore designated uses; to reduce the loss of fresh water resources by encouraging the recycling of stormwater; to enhance groundwater recharge by promoting infiltration of stormwater in areas with appropriate soils and geology; to maintain the appropriate salinity regimes in estuaries needed to support the natural flora and fauna; and to address stormwater management on a watershed basis to provide cost-effective water quality and water quantity solutions to specific watershed problems."

Paragraph 3a establishes that the Florida Department of Environmental Protection (Department or FDEP) “shall be the lead agency responsible for coordinating the state-wide stormwater management program and is responsible for establishing goals, objectives, and guidance for development and implementation of the stormwater management program by water management districts and local governments”. This section further provides for delegation of administration of the State Stormwater Management Program to water management districts which have implemented a comprehensive surface water management program.

Chapter 62-40.432, titled “Surface Water Management Regulation”, establishes guidelines for regulation of surface water management systems. Paragraph 2 of this section establishes minimum stormwater treatment performance standards as follows:

"When a stormwater management system complies with rules establishing the design and performance criteria for such systems, there shall be a rebuttable presumption that the discharge from such systems will comply with State water quality standards. The Department and the Districts, pursuant to Section 373.418, F.S., shall, when adopting rules pertaining to stormwater management systems, specify design and performance criteria for new stormwater management systems which:

1. Achieve at least 80% reduction of the average annual load of pollutants that would cause or contribute to violations of State water quality standards
2. Achieve at least 95% reduction of the average annual load of pollutants that would cause or contribute to violations of State water quality standards in Outstanding Florida Waters."

Based upon the language outlined above, all stormwater management systems designed within the State of Florida must “achieve at least 80% reduction of the annual average load of pollutants that would cause or contribute to violations of state water quality standards”. This statement forms the minimum basis for all stormwater design criteria within the State of Florida.

If stormwater management systems are designed according to the goals and guidelines established in Chapter 62-40, there is a rebuttable presumption that the discharge from the stormwater system will comply with state water quality standards. Specific numerical criteria for regulated water quality constituents are outlined in Chapter 62-302 FAC, titled “Surface Water Quality Standards”. This chapter establishes the minimum water quality levels which are necessary to protect the designated uses of a waterbody. Chapter 62-302.400 outlines five surface water classifications, according to designated uses, as follows: (1) Class I - Potable Water Supplies; (2) Class II - Shellfish Propagation or Harvesting; (3) Class III – Recreation, Propagation and Maintenance of a Healthy Well-Balanced Population of Fish and Wildlife; (4) Class IV- Agricultural Water Supplies; and (5) Class V -Navigation, Utility and Industrial Use. Water quality classifications are arranged in order of the degree of protection required, with Class I water having generally the most stringent water quality criteria and Class V the least. In general, all surface waters of the State of Florida are classified as Class III unless otherwise specified. A listing of waterbodies classified as Class I, Class II, or Class IV is given in Ch. 62-302.400(12).

Chapter 62-302.700, titled “Special Protection – Outstanding Florida Waters, Outstanding Natural Resource Waters”, establishes a list of waters within the State of Florida to be afforded a higher level of protection. No degradation of water quality is to be permitted in Outstanding Florida Waters (OFW). To achieve this goal, Chapter 62-40 establishes that stormwater management systems discharging to Outstanding Florida Waters be designed to achieve at least a 95% reduction of the average annual load of pollutants that would cause or contribute to violations of state water quality standards.

Criteria for stormwater management systems permitted within the State of Florida are outlined in Chapter 62-25, titled “Regulations of Stormwater Discharge”. Minimum design and performance standards for stormwater management systems are listed in Chapter 62-25.025, titled “Design and Performance Standards”. Stormwater management systems designed according to the criteria outlined in this section are assumed to be in compliance with water quality standards set forth in Chapter 62-302 and with the primary goals of the State Stormwater Management Program outlined in Chapter 62-40, specifically that the systems are designed to achieve at least an 80% reduction of the average annual load of pollutants that would cause or contribute to violations of state water quality standards.

Stormwater system design standards outlined in Chapter 62-25 FAC are summarized in Table 2-1. Detention and retention systems are the only types of stormwater systems referenced in this chapter. In general, both detention and retention systems must provide treatment for the runoff generated from the first 1 inch of rainfall, or as an option, for projects less than 100 acres in size, treatment for 0.5-inch of runoff. Recovery of the specified treatment volume must be achieved within 72 hours following a storm event. Specific design criteria are included for filter systems which includes guidelines on permeability, percent organic matter and silt, uniformity coefficient, and effective grain size for the filter media.

Exemptions from permitting and construction of stormwater management facilities are provided for five types of stormwater discharges, summarized at the bottom of Table 2-1. These exemptions primarily address relatively minor developments such as single-family units, duplexes, triplexes, or quadruplexes which are not part of a larger common plan of development. Exemptions are also provided for stormwater which discharges into a regional treatment facility with sufficient capacity and discharges from agricultural and silvicultural activities.

2.2 Water Management Districts

The State of Florida has been divided into five independent water management districts to address water resources and water supply issues on a regional basis within the state. Approximate boundaries for the water management districts in Florida are illustrated on Figure 2-1. The Northwest Florida Water Management District regulates water resources in the Florida Panhandle. Watersheds in this area typically drain to tributaries and rivers which ultimately discharge into the Gulf of Mexico. The Suwannee River Water Management District encompasses watershed areas which are tributary to the Suwannee River. Similarly, the St. Johns River Water Management District includes watershed areas which ultimately discharge into the St. Johns River. The Southwest Florida Water Management District includes watersheds which discharge to tributaries and rivers which ultimately reach the west coast of Florida at numerous locations. The South Florida Water Management District primarily includes areas which are tributary to Lake Okeechobee and the Florida Everglades.

TABLE 2-1
STORMWATER SYSTEM DESIGN STANDARDS
OUTLINED IN CHAPTER 62-25 FAC

STORMWATER SYSTEM TYPE	DESIGN PARAMETER	CRITERIA
Retention	Treatment Volume	Runoff from the first 1" of rainfall; or as an option, for projects < 100 ac, 0.5" of runoff
	Volume Recovery	< 72 hours following storm using percolation, evaporation, or evapotranspiration
Swales	Treatment Volume	Percolate 80% of the runoff from a 3-year/1-hour storm within 72 hours following storm
	Volume Recovery	< 72 hours following storm using percolation, evaporation, or evapotranspiration
Dry Detention	Treatment Volume	Runoff from the first 1" of rainfall; or as an option, for projects < 100 ac, 0.5" of runoff
	Volume Recovery	< 72 hours following storm
Filter Systems (if applicable)	Filter Design	Permeability \geq surrounding soil
		Media washed with <1% silt, clay, and organic matter
		Media uniformity coefficient > 1.5
		Effective grain size from 0.20-0.55 mm
		Designed with safety factor of 2
Wet Detention ¹	Treatment Volume	1.00" of runoff
	Volume Recovery	<50% in 60 hours following storm
	Detention Time	Minimum 14 days
	Littoral Zone	Minimum 30% of pond area
	Pond Depth	Maximum 8-10 ft below control elevation
	Fencing	Required for wet ponds unless side slopes are less than 4:1
Exemptions	Facilities designed to accommodate only one single-family dwelling unit, duplex, triplex, or quadruplex, provided the single unit, duplex, triplex, or quadruplex is not part of a larger common plan of development or sale	
	Facilities which are designed to serve single-family residential projects, including duplexes, triplexes, and quadruplexes, of less than 10 acres total land area and which have less than 2 acres impervious surface	
	Stormwater discharge facilities whose functioning treatment components consist entirely of swales	
	Facilities which discharge into a regional stormwater discharge facility	
	Facilities for agricultural lands, provided those facilities are part of an approved Conservation Plan	
	Facilities for silvicultural lands, provided that the facilities are constructed and operated in accordance with the Silviculture Best Management Practices Manual (1979)	

1. Requirements outlined in "Guidelines for Using Structural Stormwater Controls" from FDEP's The Florida Development Manual – A Guide to Sound Land and Water Management – Stormwater Management Practices, Chapter 6.

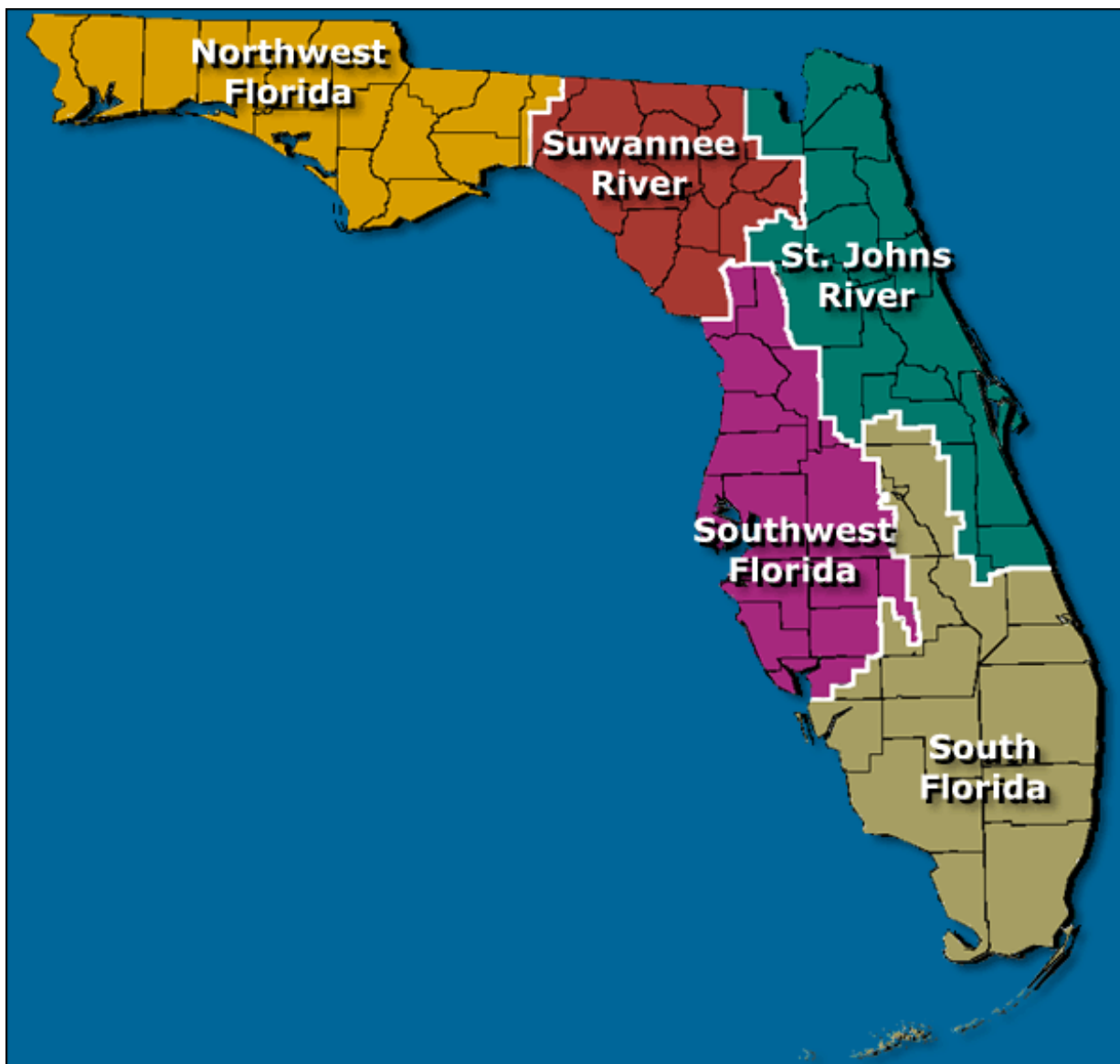

Figure 2-1. Approximate Boundaries for Water Management Districts in Florida.
(Source: FDEP Web Site)

The authority to delegate implementation of the Stormwater Management Program within the State of Florida from FDEP to the various water management districts is provided in Chapter 62-40.431. This section provides that water management districts which have implemented a Comprehensive Surface Water Management Program under Part IV of Chapter 373 (Florida Statutes) shall be the chief administrators of the State Stormwater Management Program within their districts. Using this authority, FDEP has delegated responsibility for the Stormwater Management Program to the Suwannee River, St. Johns River, Southwest Florida, and the South Florida Water Management Districts. Each of these water management districts has developed a unique set of stormwater design criteria, modeled after the minimum design criteria outlined in Chapter 62-25 FAC, and designed to achieve the minimum stormwater treatment standards specified in Chapter 62-40 FAC (Water Resource Implementation Rule).

FDEP has not delegated authority for regulation of stormwater discharges to the Northwest Florida Water Management District since this district does not have the economic and technical resources to implement a Comprehensive Surface Water Management Program at this time. As such, FDEP has retained implementation of the State Stormwater Management Program in this area and provides permitting services for all new development within the Northwest Florida district based upon the stormwater system design standards outlined in Chapter 62-25 FAC.

A comparison of existing stormwater management design system criteria within the St. Johns River, Suwannee River, Southwest Florida, and the South Florida Water Management Districts is given in Table 2-2. Design criteria are summarized for each type of stormwater management system referenced within each of the four districts, including treatment volume, volume recovery, vegetation requirements, residence time, depth, and system configuration. Criteria which do not directly impact the performance efficiency of the stormwater system (such as side slopes, minimum pipe sizes, vegetative planting success rates, etc.) are not listed in Table 2-2.

Each of the four water management districts provides design criteria for dry retention basins. In general, retention requirements are typically equivalent to the runoff volume generated by the first 0.5-inch of runoff or 1 inch of rainfall. Distinctions between off-line and on-line systems are provided in the design criteria by the St. Johns River and the Southwest Florida Water Management Districts, with increases in retention volume required for on-line systems. Volume recovery requirements for retention basins vary, ranging from full volume recovery in less than 72 hours in the St. Johns River, Suwannee River, and Southwest Florida Water Management Districts, to recovery of 50% of the treatment volume in 24 hours in the South Florida Water Management District. The St. Johns River Water Management District requires the retention basin to be stabilized with pervious material or vegetative cover, while vegetative cover is not referenced by the remaining districts.

Specifications for underdrain systems are provided by the St. Johns River Water Management District only, with treatment volume requirements similar to those specified for dry retention. Underdrain systems are not referenced by the remaining water management districts.

Underground exfiltration is specifically referenced by the St. Johns River, Southwest Florida, and South Florida Water Management Districts. In general, the treatment volume requirements for underground exfiltration systems are identical to those required for dry retention by the districts. However, volume recovery requirements vary substantially, with volume recovery required within 1 hour by the South Florida Water Management District and within 72 hours by the St. Johns River and Southwest Florida Water Management Districts.

The use of swales for stormwater treatment is referenced by both the St. Johns River and the Suwannee River Water Management Districts. Each of these districts requires percolation of 80% of the runoff generated from a 3-year/1-hour storm within the swale system, with recovery of the treatment volume in less than 72 hours. The use of swales for stormwater treatment is not specifically referenced by either the Southwest Florida or South Florida Water Management Districts.

TABLE 2-2

COMPARISON OF STORMWATER MANAGEMENT SYSTEM DESIGN CRITERIA FOR WATER MANAGEMENT DISTRICTS IN FLORIDA

STORMWATER SYSTEM TYPE	DESIGN PARAMETER	CRITERIA			
		St. Johns River Water Management District ¹	Suwannee River Water Management District ²	Southwest Florida Water Management District ³	South Florida Water Management District ⁴
Retention	Treatment Volume	Off-line retention of the first 0.5" of runoff or 1.25" of runoff from the impervious area; whichever is greater	Retention of the runoff from the first 1" of rainfall	On-line retention of the runoff from 1" of rainfall	Retention of the first 0.5" of runoff or 1.25" times the percentage of imperviousness; whichever is greater
		On-line retention of the first 1" of runoff; or 1.25" of runoff from the impervious area plus 0.5" of runoff from entire basin; whichever is greater	If project discharges to sink, then off-line or on-line retention of the runoff from the first 2" of rainfall	If project < 100 ac, on-line retention of 0.5" of runoff	
		On-line retention that percolates the runoff from the 3-year/1-hour storm		Off-line retention of runoff from 1" of rainfall	
Volume Recovery	Vegetation	For projects with <40% impervious and only HSG A soils, on-line retention from 1" of rainfall or 1.25" of runoff from impervious areas	Provide design capacity in 72 hours using percolation, evaporation, or evapotranspiration	If project < 100 ac, off-line retention of 0.5" of runoff	No more than half of treatment volume in 24 hours
		Provide design capacity in 72 hours using percolation, evaporation, or evapotranspiration	Not Referenced	Treatment volume recovered in < 72 hours	Not Referenced
		Stabilized with pervious material or permanent vegetative cover	Not Referenced		Not Referenced

- References:
1. Chapter 40C-42 FAC - Environmental Resource Permits: Regulation of Stormwater Management Systems
 2. Chapter 40B-4 - Regulations
 3. Basis of Review for Environmental Resource Permit Applications within the Southwest Florida Water Management District
 4. Basis of Review for Environmental Resource Permit Applications within the South Florida Water Management District

TABLE 2-2 -- CONTINUED

COMPARISON OF STORMWATER MANAGEMENT SYSTEM DESIGN CRITERIA FOR WATER MANAGEMENT DISTRICTS IN FLORIDA

STORMWATER SYSTEM TYPE	DESIGN PARAMETER	CRITERIA			
		St. Johns River Water Management District ¹	Suwannee River Water Management District ²	Southwest Florida Water Management District ³	South Florida Water Management District ⁴
Underdrain System	Treatment Volume	Off-line storage of the first 0.5" of runoff or 1.25" of runoff from impervious area; whichever is greater	Not Referenced	Not Referenced	Not Referenced
		On-line retention of the first 1" of runoff; or 1.25" of runoff from the impervious area plus 0.5" of runoff from entire basin; whichever is greater			
	Recovery Volume	Provide design capacity in 72 hours using percolation, evaporation, or evapotranspiration	Not Referenced	Not Referenced	Not Referenced
Vegetation		Provide at least 2 ft of indigenous soil between pond bottom and underdrain			
		Designed with a safety factor of 2	Not Referenced	Not Referenced	Not Referenced
	Stabilized with permanent vegetative cover		Not Referenced	Not Referenced	Not Referenced

- References:
1. Chapter 40C-42 FAC - Environmental Resource Permits: Regulation of Stormwater Management Systems
 2. Chapter 40B-4 - Regulations
 3. Basis of Review for Environmental Resource Permit Applications within the Southwest Florida Water Management District
 4. Basis of Review for Environmental Resource Permit Applications within the South Florida Water Management District

TABLE 2-2 -- CONTINUED

COMPARISON OF STORMWATER MANAGEMENT SYSTEM DESIGN CRITERIA FOR WATER MANAGEMENT DISTRICTS IN FLORIDA

STORMWATER SYSTEM TYPE	DESIGN PARAMETER	CRITERIA			
		St. Johns River Water Management District ¹	Suwannee River Water Management District ²	Southwest Florida Water Management District ³	South Florida Water Management District ⁴
Underground Exfiltration	Treatment Volume	Off-line storage of the first 0.5" of runoff or 1.25" of runoff from the impervious area; whichever is greater	Not Referenced	Storage of the runoff from the first 1" of rainfall If project < 100 acres, storage of 0.5" of runoff	Retention of the first 0.5" of runoff or 1.25" times the percentage of imperviousness; whichever is greater
		On-line retention of the first 1" of runoff; or 1.25" of runoff from the impervious area plus 0.5" of runoff from entire basin; whichever is greater Designed with a safety factor of 2			
	Volume Recovery	Recover design capacity within 72 hours by percolation only	Not Referenced	Recover design capacity within 72 hours by percolation only	Recover design capacity in 1 hour
		Invert elevation of trench must be > 2 ft above SHWT			

References:

1. Chapter 40C-42 FAC - Environmental Resource Permits: Regulation of Stormwater Management Systems
2. Chapter 40B-4 - Regulations
3. Basis of Review for Environmental Resource Permit Applications within the Southwest Florida Water Management District
4. Basis of Review for Environmental Resource Permit Applications within the South Florida Water Management District

TABLE 2-2 -- CONTINUED

COMPARISON OF STORMWATER MANAGEMENT SYSTEM DESIGN CRITERIA FOR WATER MANAGEMENT DISTRICTS IN FLORIDA

STORMWATER SYSTEM TYPE	DESIGN PARAMETER	CRITERIA			
		St. Johns River Water Management District ¹	Suwannee River Water Management District ²	Southwest Florida Water Management District ³	South Florida Water Management District ⁴
Wet Detention	Treatment Volume	First 1" of runoff or 2.5" of runoff from impervious area; whichever is greater	Detention of the runoff from the first 1" of rainfall If project discharges to sink, then off-line or on-line detention of the runoff from the first 2" of rainfall	First 1" of runoff from watershed	First 1" of runoff or 2.5" of runoff from impervious area; whichever is greater
	Volume Recovery	Bleed-down 50% of treatment volume in 24-30 hours	Recover design capacity in < 72 hours	50% in 60 hours; 100% in 120 hours	50% of treatment volume in 24 hours
	Residence Time	Minimum 14-day wet season (June-October)	Not Referenced	Not Referenced	Not Referenced
	Littoral Zone	30% of pond area at NWL As an alternative to littoral zone: (a) 50% additional permanent pool volume; or (b) 0.5" retention pre-treatment	Not Referenced	Minimum of 35% of pond area, concentrated at outfall	20% of pond area or 2.5% of the pond plus basin area
Pond Depth	Mean depth between 2-8 ft	Not Referenced	Not Referenced	Not Referenced	Recommended that 25-50% of pond area be > 12 ft
	Maximum depth ≤ 12 ft	Not Referenced	Not Referenced	Not Referenced	> 0.5 acre in size
Configuration	Length:Width ≥ 2:1	Not Referenced	Not Referenced	Not Referenced	100 ft minimum width

- References:
1. Chapter 40C-42 FAC - Environmental Resource Permits: Regulation of Stormwater Management Systems
 2. Chapter 40B-4 - Regulations
 3. Basis of Review for Environmental Resource Permit Applications within the Southwest Florida Water Management District
 4. Basis of Review for Environmental Resource Permit Applications within the South Florida Water Management District

TABLE 2-2 -- CONTINUED

COMPARISON OF STORMWATER MANAGEMENT SYSTEM DESIGN CRITERIA FOR WATER MANAGEMENT DISTRICTS IN FLORIDA

STORMWATER SYSTEM TYPE	DESIGN PARAMETER	CRITERIA			
		St. Johns River Water Management District ¹	Suwannee River Water Management District ²	Southwest Florida Water Management District ³	South Florida Water Management District ⁴
Swales	Treatment Volume	Percolate 80% of runoff from 3-hour/1-hour storm	Percolate 80% of runoff from 3-hour/1-hour storm	Not Referenced	Not Referenced
	Volume Recovery	Regain treatment volume in < 72 hours	Regain treatment volume in < 72 hours	Not Referenced	Not Referenced
Dry Detention	Use Restriction	a. Where HGWT or soil conditions limit use of other BMPs b. Drainage basin areas < 5 acres	None	Not Referenced	None
	Treatment Volume	Off-line detention of the first 1" of runoff or 2.5" of runoff from impervious areas	Detention of the runoff from the first 1" of rainfall If project discharges to sink, then off-line or on-line detention of the runoff from the first 2" of rainfall	Not Referenced	On-line or off-line detention of the first 0.75" of runoff or 1.88" times the percentage of imperviousness; whichever is greater
	Volume Recovery	Discharge of 50% of treatment volume in 24-30 hours	Recover design capacity in < 72 hours	Not Referenced	Recover 50% of treatment volume in 24 hours
		Areas of standing water for no more than 3 days			

- References:
1. Chapter 40C-42 FAC - Environmental Resource Permits: Regulation of Stormwater Management Systems
 2. Chapter 40B-4 - Regulations
 3. Basis of Review for Environmental Resource Permit Applications within the Southwest Florida Water Management District
 4. Basis of Review for Environmental Resource Permit Applications within the South Florida Water Management District

TABLE 2-2 -- CONTINUED

COMPARISON OF STORMWATER MANAGEMENT SYSTEM DESIGN CRITERIA FOR WATER MANAGEMENT DISTRICTS IN FLORIDA

		CRITERIA			
STORMWATER SYSTEM TYPE	DESIGN PARAMETER	St. Johns River Water Management District ¹	Suwannee River Water Management District ²	Southwest Florida Water Management District ³	South Florida Water Management District ⁴
Detention with Filtration	Treatment Volume	Offline: first 1" of runoff or 2.5" of runoff from impervious area, whichever is greater	Detention of the runoff from the first 1" of rainfall	On-line detention of the runoff from 1" of rainfall	Not Referenced
		On-line: additional 0.5" of runoff from drainage basin above off-line volume	If project discharges to sink, then off-line or on-line detention of the runoff from the first 2" of rainfall	If project < 100 ac, on-line detention of 0.5" of runoff Off-line detention of runoff from 1" of rainfall If project < 100 ac, off-line detention of 0.5" of runoff	
	Filter System	Media washed with <1% silt, clay, and organic matter	Permeability ≥ surrounding soil	Permeability ≥ surrounding soil	Not Referenced
		Media uniformity coefficient > 1.5	Media washed with <1% silt, clay, and organic matter	Media washed with <1% silt, clay, and organic matter	
		Effective grain size from 0.20-0.55 mm	Media uniformity coefficient > 1.5	Media uniformity coefficient > 1.5	
		Designed with safety factor of 2	Effective grain size from 0.20-0.55 mm	Effective grain size from 0.20-0.55 mm	
		Seasonal HGWT below invert of perforated pipe	Designed with safety factor of 2	Designed with safety factor of 2	
Discharges to OFW, Class I or II Waters	Volume Recovery	Recover treatment volume in <72 hours	Regain treatment volume in < 72 hours	Treatment volume available in < 36 hours	Not Referenced
	Treatment Volume	In general, 50% additional treatment volume above standard criteria plus 50% additional PPV for wet detention	In general, 50% additional volume above standard criteria	In general, 50% additional volume above standard criteria	In general, 50% additional volume above standard criteria; plus additional measures such as pre-treatment

- References:
1. Chapter 40C-42 FAC - Environmental Resource Permits: Regulation of Stormwater Management Systems
 2. Chapter 40B-4 - Regulations
 3. Basis of Review for Environmental Resource Permit Applications within the Southwest Florida Water Management District
 4. Basis of Review for Environmental Resource Permit Applications within the South Florida Water Management District

Wet detention stormwater treatment is specifically referenced by all the water management districts except the Suwannee River Water Management District. However, the Suwannee River Water Management District provides general detention criteria which could be interpreted as either wet or dry systems. In the three districts that provide references for wet detention, the required treatment volume is equivalent to 1 inch of runoff from the watershed or 2.5 inches of runoff from the impervious area, whichever is greater. Volume recovery requirements are variable, with recovery of 50% of the treatment volume in 24-30 hours in the St. Johns River Water Management District, 50% in 60 hours and 100% in 120 hours in the Southwest Florida Water Management District, and 50% recovery in 24 hours in the South Florida Water Management District. Residence time, perhaps the most significant factor in determining the overall performance efficiency of a wet detention system, is referenced only by the St. Johns River Water Management District which requires a minimum 14-day wet season residence time during the months from June-October. Littoral zone plantings are required by each of the three water management districts, ranging from 20% in the South Florida Water Management District to 35% in the Southwest Florida Water Management District. Requirements for pond depth, also an important design parameter, are provided by the St. Johns River and South Florida Water Management Districts. The St. Johns River Water Management District specifies shallow ponds, with a mean depth ranging from 2-8 ft and a maximum depth of 12 ft. In contrast, the South Florida Water Management District recommends that 25-50% of the pond area be greater than 12 ft to provide storage for accumulated solids.

Specific references to design criteria for dry detention (without filtration) are provided by the St. Johns River and South Florida Water Management Districts. The Suwannee River Water Management District mentions “detention” which could be inferred to mean dry detention. Treatment volume requirements are somewhat variable, with 1 inch of runoff (or 2.5 inches from impervious areas) in an off-line system in the St. Johns River Water Management District, the runoff from 1 inch of rainfall in the Suwannee River Water Management District, and 0.5 inch of runoff (or 1.88 inches x impervious area) in the South Florida Water Management District. Volume recovery is also highly variable, with recovery of 50% of the treatment volume in 24 hours by the St. Johns River and South Florida Water Management Districts, and complete recovery in 72 hours within the Suwannee River Water Management District.

Detention with filtration systems are referenced by the St. Johns River, Suwannee River, and Southwest Florida Water Management Districts. In general, the treatment volume requirements for detention with filtration systems are identical to those required for dry retention systems. Specifications are also provided for the filter system which are virtually identical to the filter system criteria outlined in Chapter 62-25. Treatment volume recovery ranges from 36 hours in the Southwest Florida Water Management District to 72 hours in the St. Johns River and Suwannee River Water Management Districts.

Each of the four water management districts provides additional supplemental criteria for stormwater management systems which discharge to OFW, Class I or II waterbodies, or sensitive areas. In general, an additional 50% treatment volume is required by the St. Johns River, Suwannee River, South Florida, and Southwest Florida Water Management Districts for discharges to these waterbodies. In addition to the enhanced treatment volume, the St. Johns River Water Management District also requires an additional 50% permanent pool volume for wet detention ponds. The South Florida Water Management District also requires additional assurances in the form of pre-treatment or other listed options.

Basin-specific criteria have been developed by the St. Johns River and South Florida Water Management Districts to address flooding and water quality concerns in sensitive basins. In general, these basin-specific criteria require additional water quality treatment and/or water quantity protection within designated basins to achieve specific water quantity or water quality goals.

Each of the water management districts also provides design criteria which regulate the rate of discharge of stormwater from developed properties to prevent flooding. In general, the post-development rate of discharge for most projects is limited to values equal to or less than those which occur from the project site under pre-development conditions, generally for a 25-year design storm. However, since these criteria do not directly relate to the water quality aspects of stormwater management systems, they are not included in the discussion presented in this section.

2.3 Local Governments

In addition to the design criteria summarized in previous sections, local governments may also develop stormwater design criteria, including alternative design criteria, provided that the design criteria meet the overall objectives and water quality goals achieved by the design criteria provided by each of the water management districts. Local governments typically include supplemental design criteria related to maintenance, safety, and aesthetic aspects of stormwater management systems such as maintenance berms, fencing, and design criteria for outfall structures to minimize transport of trash and other debris to downstream waterbodies.

Several governmental entities, such as Martin County and Leon County, have developed alternative stormwater design criteria designed to reduce post-development loadings from developed areas to levels equal to or less than pre-development loadings in areas within their jurisdiction. In Martin County, this strategy was implemented on a county-wide basis, while in Leon County this strategy was developed only for the Bradfordville area. In general, the design criteria developed for these areas to achieve no net increase in loadings under post-development conditions are substantially greater with respect to treatment volume than existing design criteria currently utilized within the State of Florida.

SECTION 3

PRECIPITATION

CHARACTERISTICS IN FLORIDA

The need for stormwater treatment in Florida is fueled by the abundance of rainfall which occurs throughout the State. The close proximity of Florida to the Atlantic Ocean and Gulf of Mexico, along with the State's many inland lakes and waterways, combine to generate high humidity and generally abundant and frequent rainfall. However, although precipitation is generally abundant in Florida, annual precipitation amounts can vary greatly from year to year, and serious droughts have occurred periodically within the State. Rainfall is unevenly distributed throughout the year in Florida, with more than half of the total annual rainfall occurring during the period from June-September when periods of extremely heavy rainfall are common. The highest 24-hour rainfall ever recorded in the United States, 38.7 inches, occurred in Yankeetown, Florida on September 5-6, 1950.

3.1 Annual and Regional Precipitation

In addition to variability in seasonal rainfall characteristics, a significant regional variability in annual precipitation has been observed throughout the State of Florida. According to the National Climatic Data Center (NCDC), 111 meteorological stations are maintained throughout the State of Florida. During February 2002, the NCDC released a summary of monthly and annual temperature and precipitation measurements at each of the 111 stations over the 30-year period from 1971-2000. A summary of this information, including a location map for each of the 111 monitoring sites, is given in Appendix A.1.

A contour isopleth map of mean annual precipitation within the State of Florida was generated by ERD based upon the mean annual precipitation values for the 111 monitoring sites summarized in Appendix A.1. Data from additional meteorological monitoring sites in Alabama, Georgia, and Louisiana (generally within 100 miles of Florida) were also obtained to provide a smoother transition for the contour lines in the vicinity of the State boundary. The mean rainfall data obtained from these adjacent stations was also provided by the NCDC as summaries of data collected over the period 1971-2000. An additional 49 meteorological monitoring locations were included in this supplemental data set, for a total of 160 meteorological monitoring sites used for generation of rainfall contour isopleths. A complete listing of geographical coordinates and mean annual rainfall from 1971-2000 is given in Appendix A.2 for each of the 160 monitoring sites, and locations of these monitoring sites are shown on Figure 3-1.

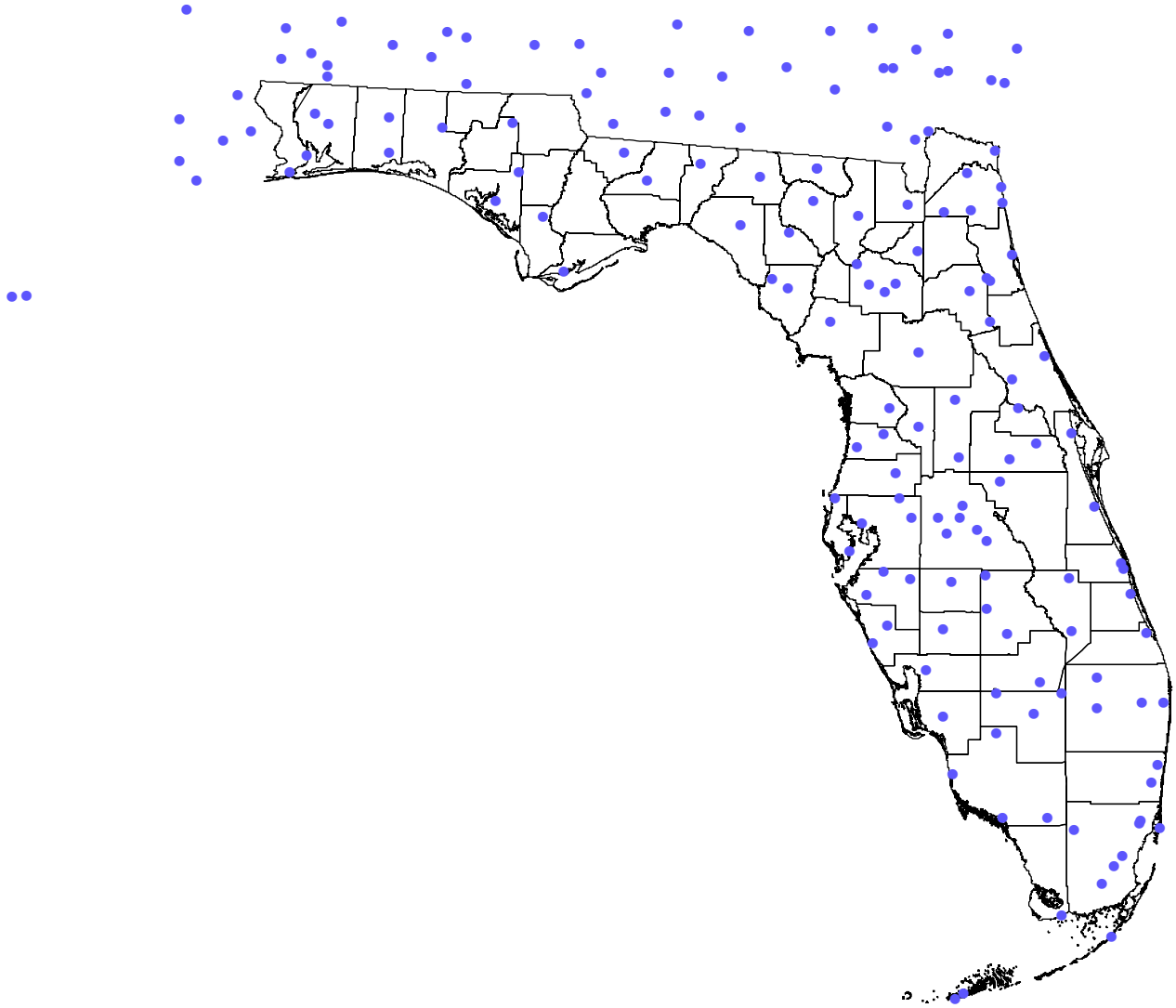

Figure 3-1. Locations of Meteorological Monitoring Sites.

An isopleth map of annual precipitation within the State of Florida during the 30-year period from 1971-2000, generated using the process outlined previously, is given in Figure 3-2. In general, average rainfall within the State ranges from approximately 38-66 inches/year, depending upon location within the State. The greatest annual precipitation within the State occurs in western portions of the Florida Panhandle. In addition to the summer time convective storms which affect most of the State, this area is also impacted by precipitation from frontal boundaries which often dissipate before reaching more southern portions of the State. The lowest annual precipitation was recorded in the Florida Keys. Expanded regional versions of the rainfall isopleths map are given in Appendix A.3.

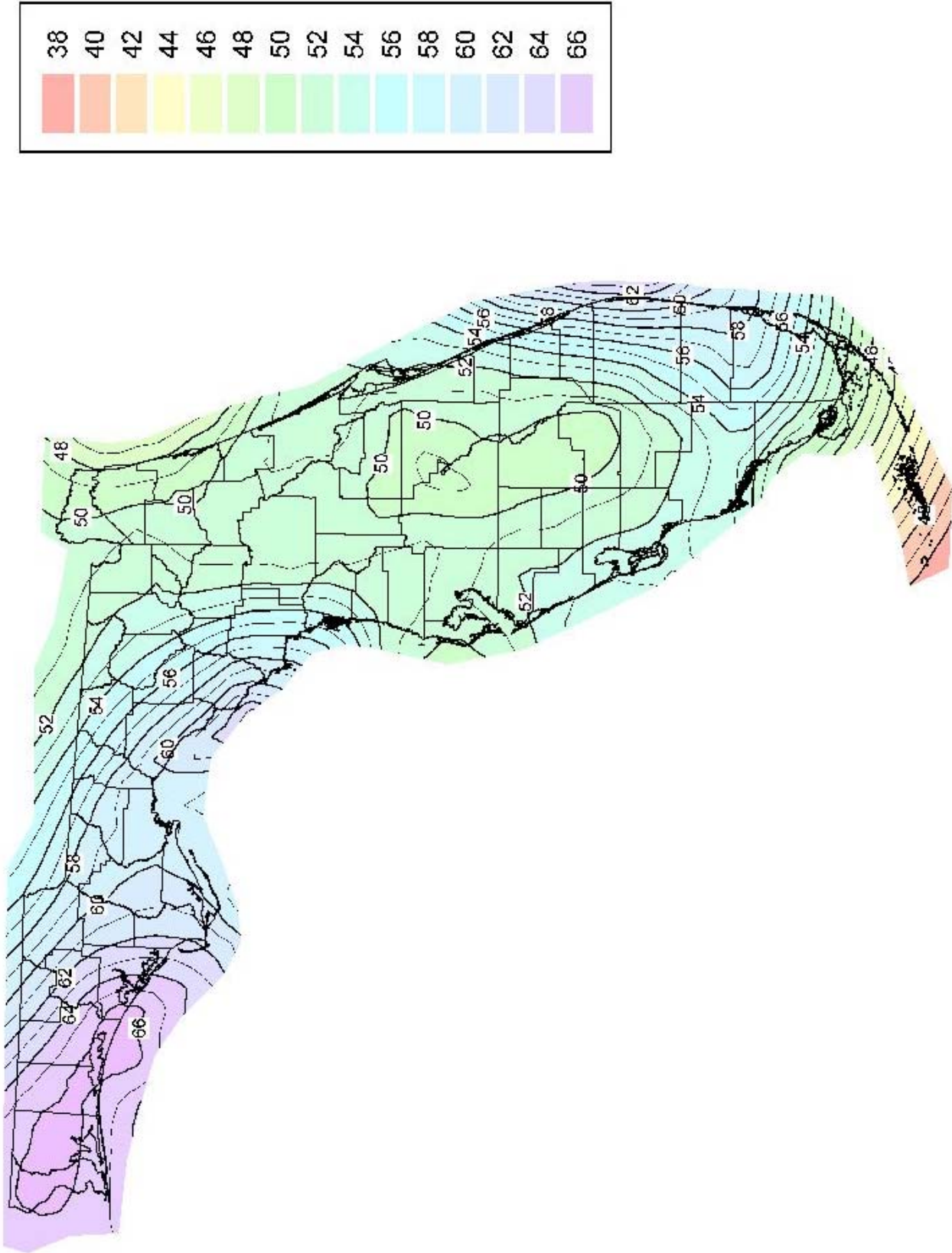

Figure 3-2. Isopleths of Mean Annual Precipitation in Florida from 1971-2000.

Additional regions of elevated rainfall, with annual precipitation ranging from approximately 58-62 inches/year, are apparent in the Big Bend Coastal and the Southeast Coastal regions of the State. The Big Bend Coastal area is impacted by many of the same precipitation processes that occur within the Panhandle region, while the Southeast Coastal region is impacted heavily by summer time convective thunderstorm activity. The remaining portions of the State, excluding the Florida Keys, have annual precipitation ranging from approximately 45-55 inches/year, with lower precipitation in central portions of the State and higher precipitation in coastal areas.

In addition to the regional variability in mean annual precipitation illustrated on Figure 3-2, a significant variability also exists with respect to the frequency and types of individual rain events which occur throughout the state. For example, coastal areas (particularly in southern portions of the State) often have small convective rainfall events due to the proximity of open water. A large number of the rain events which occurred in these areas are less than 0.2 inches. In contrast, areas within the Panhandle receive a large portion of their annual rainfall from periodic frontal boundaries which typically dissipate before reaching other parts of the State.

The National Climatic Data Center (NCDC) has collected long-term rainfall data at numerous precipitation recording stations within the State of Florida. This database was reviewed to identify rainfall recording stations which would be representative of rainfall conditions in various areas of the State. Eleven separate meteorological stations were selected, scattered from the Panhandle to the Florida Keys, to examine variability in the characteristics of individual rain events across the State. Locations of the selected meteorological sites are indicated on Figure 3-3. In general, it was desired that the monitoring stations contain a maximum period of record with a minimum amount of missing data. Years within the period of record which contain one or more months of missing data were generally excluded from the database, providing a data set with continuous rainfall data for each year included within the set.

Characteristics of the selected meteorological sites in Florida are summarized in Table 3-1. This table includes a descriptive name to identify the general location of the monitoring site, the mean annual rainfall measured at the monitoring site, and the period of record included in the meteorological data. Continuous rainfall records were initiated in 1942 at seven of the 11 sites included in Table 3-1. Records at four additional sites were begun between 1946 and 1949. The period of rainfall records included in data sets for each of the 11 sites is summarized in the final column of Table 3-1. Each entry includes the period of record as well as the number of years of complete data available for evaluation of rain event characteristics.

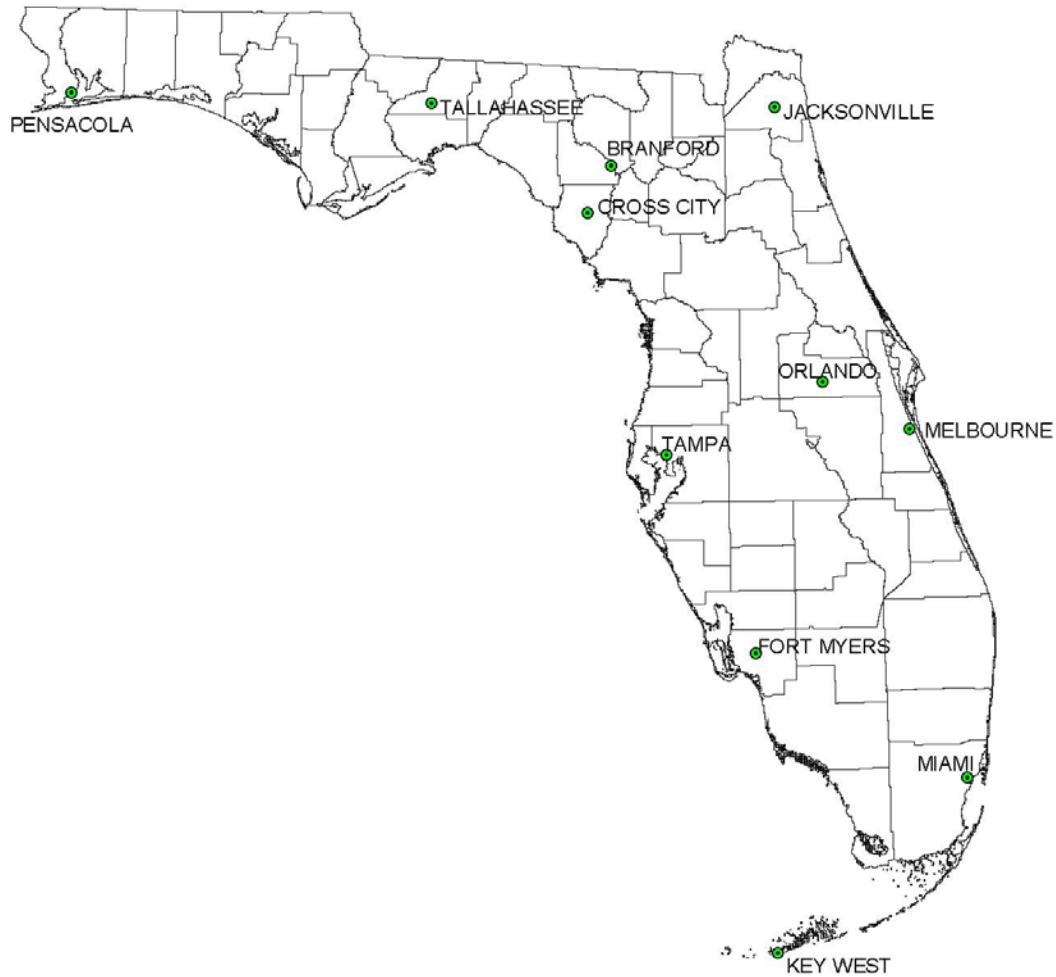

Figure 3-3. Locations of Selected Meteorological Sites.

TABLE 3-1

**CHARACTERISTICS OF SELECTED
METEOROLOGICAL SITES IN FLORIDA**

GENERAL LOCATION	MONITORING SITE	MEAN ANNUAL RAINFALL (in/yr)	PERIOD OF RECORD
Panhandle	Pensacola	62.17	Pensacola: 33 years (1942-2005) Tallahassee: 45 years (1959-2005)
	Tallahassee	64.55	
Big Bend Coastal	Cross City	55.14	47 years (1942-2000)
Northeast Coastal	Jacksonville	52.96	64 years (1942-2005)
North Florida	Branford	52.27	53 years (1945-2004)
Central	Orlando	50.03	62 years (1942-2005)
East Central Coastal	Melbourne	47.52	47 years (1942-2005)
West Central Coastal	Tampa	46.07	47 years (1949-2005)
Southwest Coastal	Ft. Myers	53.13	28 years (1960-2003)
Southeast Coastal	Miami	56.92	64 years (1942-2005)
Florida Keys	Key West	39.07	63 years (1942-2005)

3.2 Rainfall Event Characteristics

A probability distribution of individual rain events occurring during the period of record for each of the selected meteorological sites was developed by evaluating common rain events occurring at each of the sites during an average year. Hourly meteorological data was obtained from the NCDC for each of the selected meteorological sites. The continuous hourly rainfall record for each site was scanned to determine the total rainfall depth for individual rain events which occurred at the monitoring site over the period of record.

For purposes of this analysis, a rain event is defined as a period of continuous rainfall. The US EPA typically uses a 6-hour separation for defining individual rain events. Using this criterion, rain episodes separated by less than six hours of dry conditions are considered to be one continuous event, while rain events separated by six hours or more of dry conditions are assumed to be separate events. The six-hour separation period is thought to be the minimum period of no rainfall required to restore the hydrologic characteristics of the site to pre-rain event conditions. Although this definition may work well in the temperate climates present throughout much of the U.S., this definition fails to consider the small convective events which occur frequently within the State of Florida, particularly during the summer months. For rain events in the range of 0.25 inches or more, an inter-event separation period of approximately six hours seems adequate to restore hydrologic characteristics for a Florida watershed. However, for events less than 0.25 inches, hydrologic characteristics can be restored rapidly, often within several hours. Therefore, for purposes of this evaluation, a variable inter-event dry period is utilized. When the cumulative hourly rainfall is equal to 0.25 inches or more, an inter-event dry period of six hours is required to initiate the start of a new rain event. Rainfall which occurs less than six hours from the termination of the previous rainfall is assumed to be part of the original rainfall event. However, for rain events less than 0.25 inches, an inter-event dry period of three hours is used to indicate the start of a new independent runoff event.

The available data sets for each of the 11 meteorological sites were scanned and divided into individual rain events based upon the criteria outlined previously. Individual rainfall events at each of the 11 monitoring sites were divided into 19 rainfall event ranges which include 0.00-0.10 inches, 0.11-0.20 inches, 0.21-0.30 inches, 0.31-0.40 inches, 0.41-0.50 inches, 0.51-1.00 inch, 1.01-1.50 inches, 1.51-2.00 inches, 2.01-2.50 inches, 2.51-3.00 inches, 3.01-3.50 inches, 3.51-4.00 inches, 4.01-4.50 inches, 4.51-5.00 inches, 5.01-6.00 inches, 6.01-7.00 inches, 7.01-8.00 inches, 8.01-9.00 inches, and greater than 9 inches. For each rainfall event range, the mean depth of rain events within the interval was calculated. A probability distribution was performed on all rainfall events within each rainfall event range to determine the average number of rain events, the mean rainfall duration, the mean antecedent dry period, the annual rainfall depth contributed by each interval, the cumulative annual event volume, and cumulative percentage of annual rainfall for each rainfall event range. Frequency distributions of rain events in each of the 11 meteorological sites are given in Appendix A.4.

A comparison of the percentage of annual rain events occurring within the selected event intervals at the regional sites is given in Table 3-2. In general, it appears that the Key West and Miami monitoring sites have a higher percentage of relatively small events, which generate relatively little measurable runoff, and a lower percentage of larger rain events, compared with the remaining monitoring sites. For example, approximately 83.7% of the rain events occurring at the Key West monitoring site and 80.6% of the events occurring at the Miami monitoring sites are equal to 0.5 inch or less compared with a state-wide average of 75.1%. Conversely, the Ft. Myers and Cross City monitoring sites appear to have a lower percentage of small rain events, with 72.6% of the events at the Ft. Myers site and 70.8% of the events at the Cross City site having rainfall depths equivalent to 0.5 inches or less. The Pensacola, Tallahassee, and Ft. Myers monitoring sites appear to have a higher percentage of large rain events, with 5.3% of the Pensacola and Tallahassee and 3.9% of the Ft. Myers rain events equivalent to 2 inches or greater compared with a state-wide average of 3.6% for this interval. A graphical comparison of the percentage of annual rainfall events less than 1 inch in depth at each of the designated regional sites is given in Figure 3-4.

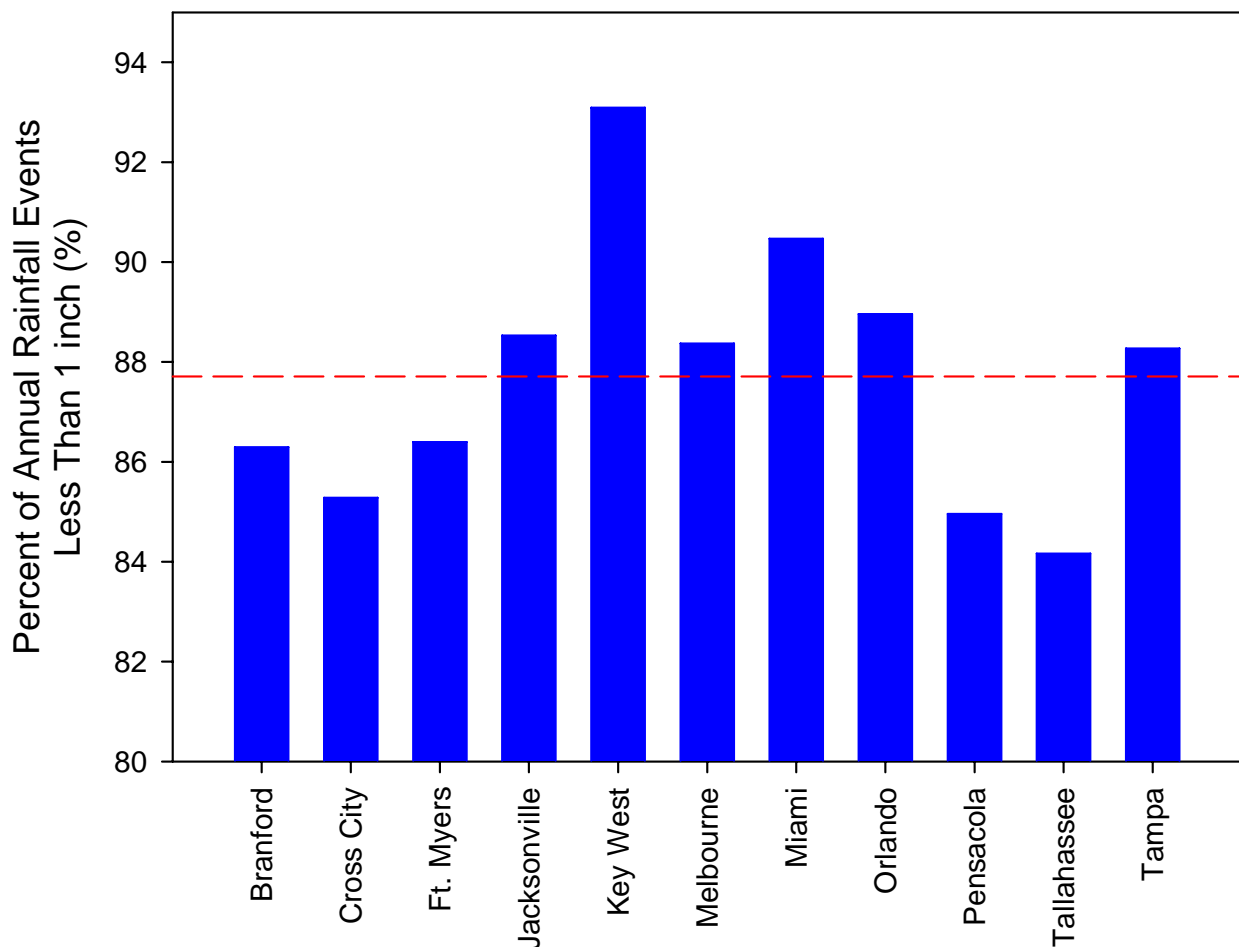

Figure 3-4. Percentage of Annual Rain Events Less than 1 inch at the Selected Regional Sites.

TABLE 3-2
PERCENTAGE OF ANNUAL RAIN EVENTS
OCCURRING IN SELECTED EVENT INTERVALS

RAINFALL STATION	AVERAGE NUMBER OF RAIN EVENTS	PERCENTAGE OF THE NUMBER OF RAIN EVENTS FOR VARIOUS RAINFALL EVENT INTERVALS																					
		0.00-0.10	0.11-0.20	0.21-0.30	0.31-0.40	0.41-0.50	0.51-1.00	1.01-1.50	1.51-2.00	2.01-2.50	2.51-3.00	3.01-3.50	3.51-4.00	4.01-4.50	4.51-5.00	5.01-6.00	6.01-7.00	7.01-8.00	8.01-9.00	9.01-15.00	15.01-20.00		
Branford	105.85	39.8	13.2	8.2	6.0	4.4	14.6	6.4	3.6	1.7	0.8	0.4	0.2	0.2	0.1	0.1	0.1	0.0	0.0	0.0	0.1	0.0	0.0
Cross City	104.23	36.8	14.0	8.6	6.6	4.8	14.5	6.8	3.3	1.9	1.1	0.6	0.3	0.2	0.1	0.2	0.1	0.0	0.1	0.0	0.0	0.0	0.0
Ft. Myers	108.96	39.2	14.7	9.0	5.2	4.5	13.8	6.4	3.3	1.7	0.8	0.5	0.2	0.1	0.2	0.2	0.0	0.1	0.1	0.0	0.0	0.0	0.0
Jacksonville	127.23	43.8	14.5	7.7	6.2	3.8	12.5	5.3	2.7	1.4	0.9	0.3	0.3	0.2	0.2	0.1	0.1	0.0	0.1	0.0	0.1	0.0	0.0
Key West	127.51	53.7	14.6	6.7	5.5	3.2	9.4	3.2	1.6	0.6	0.4	0.3	0.1	0.1	0.0	0.1	0.1	0.0	0.0	0.0	0.0	0.0	0.0
Melbourne	107.38	41.8	15.8	7.8	6.0	4.0	12.9	5.9	2.7	1.2	0.7	0.4	0.2	0.2	0.1	0.1	0.0	0.1	0.0	0.0	0.0	0.0	0.0
Miami	158.03	50.2	14.6	7.0	5.3	3.5	9.9	4.2	2.2	1.2	0.8	0.3	0.2	0.2	0.1	0.1	0.1	0.0	0.0	0.0	0.0	0.0	0.0
Orlando	126.53	43.3	15.6	7.2	5.7	4.2	12.9	5.5	2.6	1.2	0.7	0.3	0.2	0.1	0.1	0.2	0.0	0.0	0.0	0.0	0.0	0.0	0.0
Pensacola	126.09	45.6	12.9	5.9	4.9	3.4	12.2	6.4	3.4	1.9	1.1	0.6	0.3	0.4	0.2	0.3	0.1	0.2	0.0	0.1	0.0	0.0	0.0
Tallahassee	123.78	40.4	12.6	7.0	6.1	4.3	13.8	7.1	3.4	1.9	1.1	0.9	0.4	0.2	0.2	0.2	0.2	0.1	0.1	0.1	0.0	0.0	0.0
Tampa	111.74	43.4	14.0	7.8	6.1	4.4	12.6	5.7	2.7	1.4	0.6	0.5	0.3	0.2	0.1	0.1	0.0	0.0	0.0	0.0	0.1	0.0	0.0
Minimum	104.23	36.8	12.6	5.9	4.9	3.2	9.4	3.2	1.6	0.6	0.4	0.3	0.1	0.1	0.0	0.1	0.0	0.0	0.0	0.0	0.0	0.0	0.0
Maximum	158.03	53.7	15.8	9.0	6.6	4.8	14.6	7.1	3.6	1.9	1.1	0.9	0.4	0.4	0.2	0.3	0.2	0.2	0.1	0.1	0.1	0.0	0.0
Mean	120.67	43.5	14.2	7.5	5.8	4.1	12.7	5.7	2.9	1.5	0.8	0.5	0.3	0.2	0.1	0.2	0.1	0.1	0.0	0.1	0.0	0.1	0.0

A comparison of the mean number of annual rainfall events at each of the designated regional sites is given in Figure 3-5. The highest number of annual events occurs at the Miami monitoring site, with approximately 158 events measured each year. The smallest number of annual rain events occurs at the Cross City monitoring site, with a mean of 104 events measured per year.

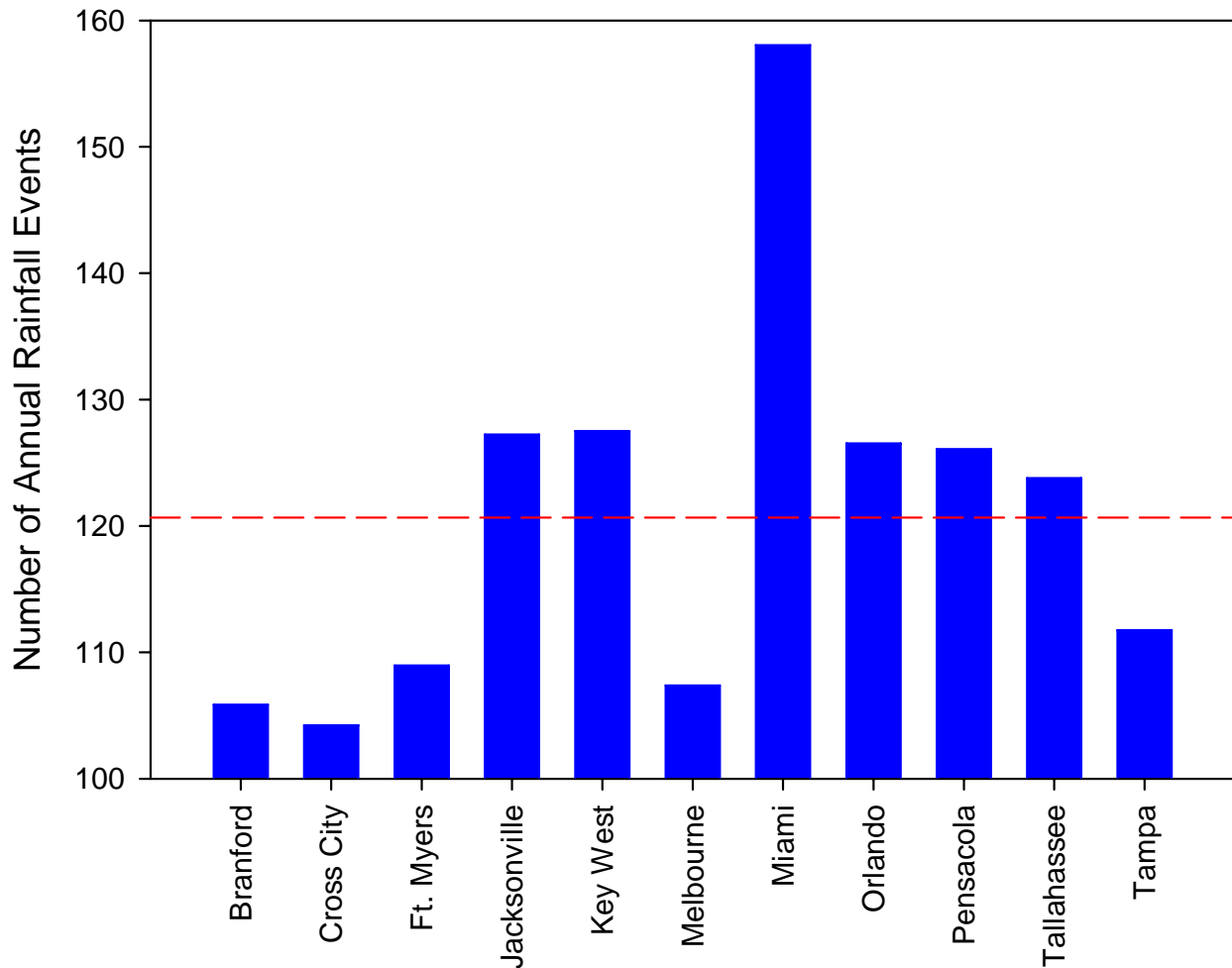

Figure 3-5. Comparison of the Mean Number of Annual Rainfall Events at the Selected Regional Sites.

3.3 Antecedent Dry Period

An evaluation of mean antecedent dry period was also conducted for the individual rain events measured at each of the selected regional monitoring sites. This information was evaluated on both a dry season (October-May) and wet season (June-September) basis. Information on antecedent dry period is useful in evaluating recovery times for stormwater management systems which must recover stored treatment volumes prior to the next significant rain event.

A comparison of mean antecedent dry periods for rain events at the selected regional sites during dry and wet season conditions is given in Table 3-3 and Figure 3-6. Mean antecedent dry periods between rain events range from 3.03-5.63 days under dry season conditions, with an overall average of 4.12 days. Under wet season conditions, mean antecedent dry periods range from 1.42-2.27 days with an overall mean of 1.89 days.

TABLE 3-3

**MEAN ANTECEDENT DRY PERIODS FOR RAIN
EVENTS AT THE DESIGNATED REGIONAL SITES**

STATION	ANTECEDENT DRY PERIOD (days)	
	DRY SEASON	WET SEASON
Branford	4.40	2.14
Cross City	4.87	2.01
Ft. Myers	5.63	1.75
Jacksonville	3.59	1.84
Key West	3.92	1.80
Melbourne	4.14	2.27
Miami	3.03	1.42
Orlando	3.96	1.73
Pensacola	3.36	1.99
Tallahassee	3.73	1.87
Tampa	4.65	1.93
Minimum	3.03	1.42
Maximum	5.63	2.27
Mean	4.12	1.89

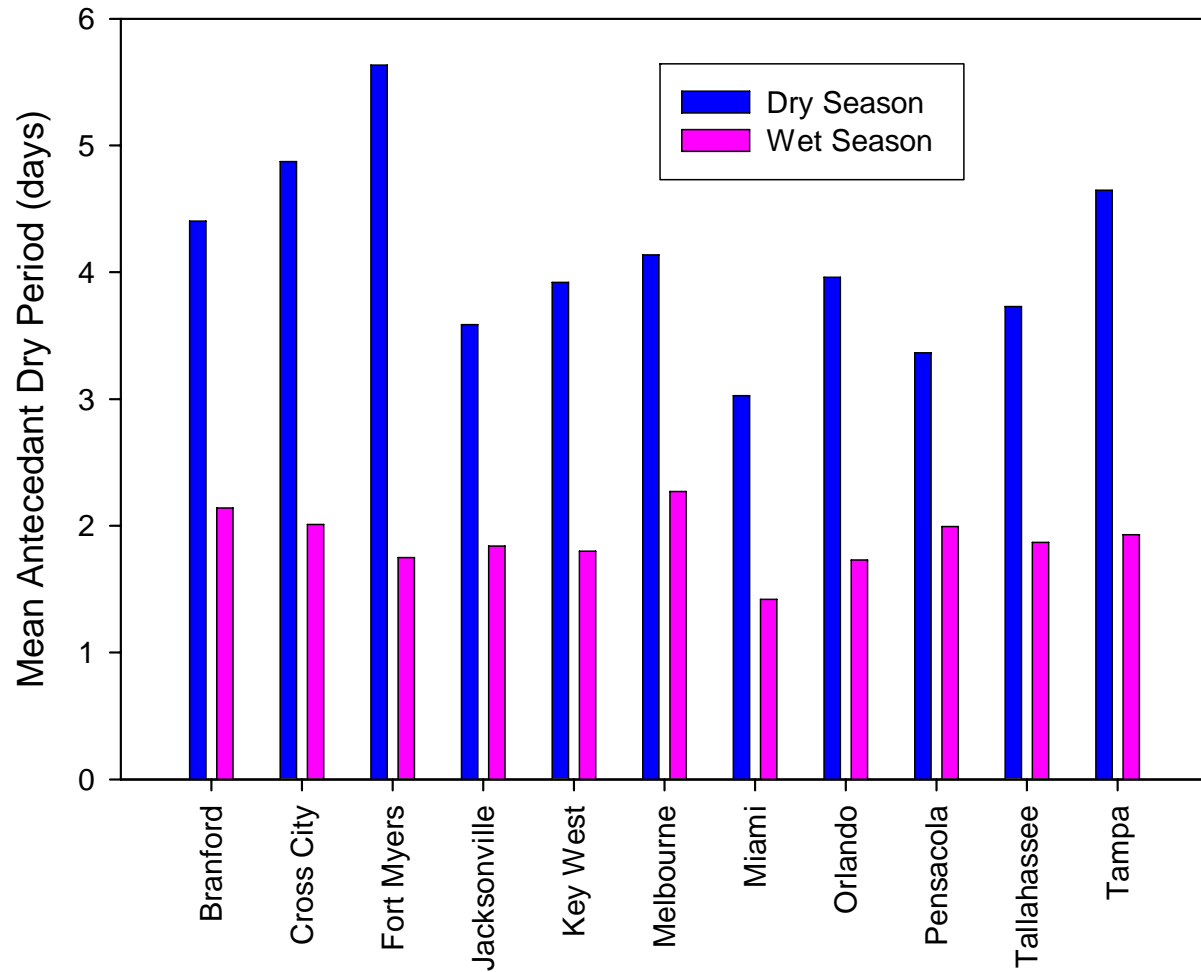

Figure 3-6. Comparison of Dry and Wet Season Antecedent Dry Periods at the Regional Monitoring Sites.

SECTION 4

STORMWATER RUNOFF – QUALITY AND QUANTITY

The performance efficiency and effectiveness of stormwater treatment systems are closely linked to the quantity and quality of the generated stormwater stream. Issues related to the quantity and quality of stormwater runoff form the basis of existing stormwater treatment design criteria. A discussion of the quality and quantity of stormwater runoff generated by various land use categories is given in the following sections.

4.1 Water Quality Characteristics

4.1.1 Data Availability

A multitude of stormwater characterization studies have been conducted within the State of Florida as part of research projects, permit monitoring requirements, retrofit projects, and NPDES permitting. Land use categories included in runoff characterization studies can typically be grouped into one of 12 general land use designations which are commonly used in pollutant loading evaluations. A summary of these general land use categories is given in Table 4-1.

When performing pollutant loading studies for large watershed areas, land use information is often obtained as FLUCCS codes (Florida Land Use Code and Classification System). This system typically provides multiple sub-categories for each of the 12 general land use categories summarized in Table 4-1 based upon differences in percentage imperviousness, vegetative cover, and development density. Unfortunately, detailed runoff characterization data are not available for most of these sub-categories. As a result, when performing pollutant loading studies, detailed land use categories represented by FLUCCS codes must often be assigned to one of the 12 general land use categories summarized in Table 4-1 for estimation of pollutant loadings. This assignment is typically performed based upon anticipated similarities in hydrologic and pollutant loading characteristics between the detailed FLUCCS code designations and the general land use categories.

A summary of the availability of runoff characterization data for various pollutant categories and land use types is given in Table 4-2. Good runoff characterization data is generally available for suspended solids in each of the land use categories summarized in Table 4-1. A similar level of characterization data availability is present for total nitrogen and total phosphorus in virtually all land use categories. However, information on dissolved species of nitrogen and phosphorus is relatively limited in the existing literature.

TABLE 4-1
GENERAL LAND USE CATEGORIES
FOR RUNOFF CHARACTERIZATION DATA

GENERAL CATEGORY	DESCRIPTION
Low-Density Residential	Rural areas with lot sizes greater than 1 acre or less than one dwelling unit per acre; internal roadways associated with the homes are also included
Single-Family Residential	Typical detached home community with lot sizes generally less than 1 acre and dwelling densities greater than one dwelling unit per acre; duplexes constructed on one-third to one-half acre lots are also included in this category; internal roadways associated with the homes are also included
Multi-Family Residential	Residential land use consisting primarily of apartments, condominiums, and cluster-homes; internal roadways associated with the homes are also included
Low-Intensity Commercial	Areas which receive only a moderate amount of traffic volume where cars are parked during the day for extended periods of time; these areas include universities, schools, professional office sites, and small shopping centers; internal roadways associated with the development are also included
High-Intensity Commercial	Land use consisting of commercial areas with high levels of traffic volume and constant traffic moving in and out of the area; includes downtown areas, commercial sites, regional malls, and associated parking lots; internal roadways associated with the development are also included
Industrial	Land uses include manufacturing, shipping and transportation services, sewage treatment facilities, water supply plants, and solid waste disposal; internal roadways associated with the development are also included
Highway	Includes major road systems, such as interstate highways and major arteries and thoroughfares; roadway areas associated with residential, commercial, and industrial land use categories are already included in loading rates for these categories
Agriculture	Includes cattle, grazing, row crops, citrus, and related activities
Open/ Undeveloped	Includes open space, barren land, undeveloped land which may be occupied by native vegetation, rangeland, and power lines; this land does not include golf course areas which are heavily fertilized and managed; golf course areas have runoff characteristics most similar to single-family residential areas
Mining/ Extractive	Includes a wide variety of mining activities for resources such as phosphate, sand, gravel, clay, shell, etc.
Wetlands	Include a wide range of diverse wetland types, such as hardwood wetlands, cypress stands, grassed wetlands, freshwater marsh, and mixed wetland associations
Open Water/ Lakes	Land use consists of open water and lakes, rivers, reservoirs, and other open waterbodies

TABLE 4-2
RUNOFF CHARACTERIZATION DATA AVAILABILITY

PARAMETER GROUP	SPECIES	DATA AVAILABILITY	LAND USES
Suspended Solids	TSS	Good	All
Nutrients	Total N Total P	Good	All
	NH ₃ NO _x TKN Ortho-P	Limited	Limited
Metals	Zinc Lead Copper	Fair to Good	Commercial, Residential, and Highway
	Cadmium Nickel Diss. Metals	Poor to Fair	Commercial, Residential, and Highway
Oxygen Demanding Substances	BOD	Fair to Good	Commercial, Residential, and Highway
	COD	Poor to Fair	Commercial, Residential, and Highway
Oils, Greases, and Hydrocarbons	Oil and Grease TRPH	Poor	Commercial, Residential, and Highway
	Specific Compounds	Extremely Poor	Commercial, Residential, and Highway
Pathogens	Total Coliform Fecal Coliform	Poor	Commercial, Residential, and Highway
	E. Coli	Extremely Poor	Commercial, Residential, and Highway

Runoff characterization data for zinc, lead, and copper are most commonly available for commercial, residential, and highway land uses. However, even in these categories, the availability of the data is only considered to be fair to good. Information on other heavy metals, such as cadmium, chromium, and nickel, as well as dissolved metal species, is poor in virtually all land use categories. The only studies which include these latter parameters appear to be research-related projects.

Runoff characterization data for biochemical oxygen demand (BOD) is fair to good in commercial, residential, and highway land use categories. A limited amount of information for this parameter is also present in agricultural studies. However, chemical oxygen demand (COD) is measured relatively infrequently, and the data availability for this parameter is considered poor to fair.

Oils, greases, and hydrocarbons are measured on an infrequent basis in stormwater characterization studies. Most of the studies including these parameters are research projects, many of which are designed specifically to address these compounds. Oils, greases, and hydrocarbons are generally evaluated through the generic oil and grease or TRPH (total recoverable petroleum hydrocarbon) lab tests. Testing for specific compounds is extremely rare within the literature.

Information on pathogens, such as total and fecal coliform, is poor in the available literature, with the majority of information addressing commercial, residential, and highway land uses. Information on more specific pathogens, such as E. coli, is extremely poor for virtually all land use categories.

A literature review was conducted by Harper during 1992-93 to identify significant stormwater characterization studies performed within the State of Florida. Basic information for many of the evaluated land uses was obtained from the document by Harper (1994) titled "Stormwater Loading Rate Parameters for Central and South Florida". This report presents the results of an extensive literature search and analysis of runoff characteristics for selected parameters and land use types within Central and South Florida. The runoff characteristics provided in this document include publications and studies conducted specifically within the State of Florida by a variety of state, federal, and local governments, along with private consultants.

Each study was reviewed for adequacy of the database, with special attention to factors such as length of study, number of runoff events monitored, monitoring methodology, as well as completeness and accuracy of the work. In general, it is preferred that selected studies present at least a one-year period of data collection representing a wide range of rainfall and antecedent dry period conditions. Unfortunately, in a number of cases, the only available data base for a given land use category or loading parameter represented a relatively small and limited data collection process. These studies were carefully examined on a case-by-case basis and a decision was made as to whether or not to include the data in loading rate estimates. No studies with less than five storm sample events were used. An important requirement for inclusion of stormwater monitoring data is that the study measures only a homogeneous watershed area. This requirement is necessary since input into most loading rate models is based upon homogeneous land use types. Unfortunately, this requirement limited the usefulness of several thorough stormwater studies by the USGS which evaluated mixed land use areas.

Approximately 120 reports and publications of stormwater research conducted within the State of Florida were initially reviewed as a part of the literature search process. During the initial review process, studies which contain an insufficient number of sample events or address mixed land use areas were removed from further consideration, leaving approximately 40 reports with potential pollutant loading information.

The Harper (1994) report includes all significant stormwater characterization studies performed in Florida prior to the early 1990s. However, a limited number of additional runoff characterization studies have been performed since the publication date for this report. Therefore, a supplemental literature search was performed by ERD to identify additional resources for characterization data. Additional land use characterization studies were obtained for single-family residential areas, low-intensity commercial, highway/transportation land use, agriculture-citrus, agriculture-row crop, and open space/undeveloped/rangeland/forest areas. The supplemental characterization data were combined with the data provided by Harper (1994) to generate a database reflecting all significant characterization studies performed in Florida. A brief summary of information contained within selected characterization studies from the combined database is given in Table 4-3. A listing of hydrologic and general characteristics for studies included in the combined database is given in Appendix B.

TABLE 4-3

SUMMARY OF SELECTED STORMWATER CHARACTERIZATION STUDIES PERFORMED IN THE STATE OF FLORIDA

REFERENCE	LOCATION OF STUDY AREA	LAND USE TYPE	PARAMETERS MEASURED	COMMENTS
Federico (1977)	Taylor Creek Drainage Basin, FL	1. Pasture 2. Dairy 3. Citrus	General Parameters, Nutrients	An average of 43 daily composite samples collected in drainage ditches from July to September 1975. Data presented as concentration only with no hydrologic data for direct conversion to loading rates.
East Central Florida Regional Planning Council (ECFRPC) (1978)	Central Florida Area	1. Residential 2. Commercial 3. Pasture 4. Well-drained Flatwoods 5. Range 6. Lake 7. Swamp	Nutrients, BOD, Solids	Presents summaries of studies conducted in Central Florida with results expressed in concentration and loading rate forms.
Gaggiari, et al. (1978)	Maitland, FL	Primarily residential	Nutrients, Major Ions, Heavy Metals	Bulk precipitation and runoff samples were collected from 3 adjacent watersheds from April 1971 to June 1974. A total of 46 storm events were monitored. Data includes event mean concentration and mass loading for storm events.
Miller (1979)	Southeast Florida Coastal Area	1. 17.9 acres low-density residential 2. 58.3 acres highway basin 3. 20.4 acres commercial 4. 14.7 acres high-density residential	None	Report gives detailed hydrologic information on the four drainage basins. Results of runoff sampling programs are given in other publications by the author.
Weinberg, et al. (1980)	Broward County, FL	26 acres of high-density residential	General Parameters, Nutrients	Grab samples and timed samples collected from 2 rain events during 1975. Insufficient data base.
Matraw, et al. (1981)	Broward County	3 separate areas: 1. 40.8-acre single-family residential (43.9% imp.) 2. 58.3-acre 6-lane highway (36.2% imp.) 3. 28.4-acre commercial (regional shopping mall, 98% imp.)	General Parameters, Nutrients, Metals, Bacteria	More than 30 flow-weighted samples collected from 1974-1977. Data presented as concentration and loadings. Detailed hydrology provided for each basin.

TABLE 4-3 -- CONTINUED
SUMMARY OF SELECTED STORMWATER CHARACTERIZATION
STUDIES PERFORMED IN THE STATE OF FLORIDA

REFERENCE	LOCATION OF STUDY AREA	LAND USE TYPE	PARAMETERS MEASURED	COMMENTS
Harper, et al. (1982)	Orlando, FL	160 acres of high-density commercial and residential	General Parameters, Solids, BOD, Metals, Nutrients	Runoff collected from mixed residential and commercial watersheds during 1978 using manual and automatic techniques. Data presented in both concentration and loading rate forms but represents mixed land use.
Waller (1982)	Dade County, FL	1. Commercial 2. State Park 3. Residential 4. Row Crops 5. Agricultural	General Parameters, Nutrients, Heavy Metals	Runoff samples collected from June to October 1978 only for storms of intensity equal to or exceeding 1.0 inch/hour. Data cannot be used for loading rate estimation since typical less intense storm events were not monitored.
Wanielista, et al. (1982)	Orlando, FL	1. Residential 2. Commercial	General Parameters, Nutrients, Metals	Four runoff events were collected from separate residential and commercial watersheds from July to November 1978 using manual flow-weighted collection techniques. Data presented in both concentration and loading rate forms. However, the data base is small and covers only a portion of the year. Residential area receives heavy traffic volume from adjacent downtown area.
Yousef, et al. (1982)	Orlando, FL	Interstate Highway (I-4)	General Parameters, Nutrients, Metals	Runoff from highway bridges was collected from 11 storm events during August 1975. Data presented in concentration form only. Sampling program and hydrologic information sufficient to generate annual loadings, but data is specific to bridge or highway runoff only.
German (1983)	Maitland, FL	2 Sub-basins: Residential and Highway	General Parameters, Nutrients, Metals	39 runoff events sampled in residential areas and 17 samples in highway areas from 1975-1979.
McKenzie, et al. (1983)	Miami, FL	1.43 acre Interstate Highway (I-95)	General Parameters, Nutrients, Metals	Runoff collected during 5 storm events from November 1979 to May 1981 using automated instrumentation. Data presented as both concentration and loading rates, but is specific only to highway systems.
Cullum (1984) Greg (1984)	Boca Raton, FL	122 acres single-family residential	General Parameters, Nutrients	Detailed hydrologic concentration and mass loading data. However, only rain events in excess of 1 inch were sampled.
ECFRPC (1984)	Central Florida	11 land use types	Nutrients, BOD, Solids	Presents concentration and loading rate information for expanded land use categories not presented in earlier 1978 publication. Data generated from Central Florida studies funded by ECFRPC. Hydrologic information is also provided.

TABLE 4-3 -- CONTINUED

SUMMARY OF SELECTED STORMWATER CHARACTERIZATION STUDIES PERFORMED IN THE STATE OF FLORIDA

REFERENCE	LOCATION OF STUDY AREA	LAND USE TYPE	PARAMETERS MEASURED	COMMENTS
Lopez, et al. (1984)	Tampa Bay, FL	A mixed-use urban watershed	General Parameters, Nutrients, Heavy Metals	Detailed study from 1975-1980 including streamflow, climate, physiographic and water quality data. Extremely detailed discussion of watershed characteristics. Data presented in both concentration and loading rate formats. Although land use is mixed, 3 of the 9 sites are approximately 70% residential which may be useful for single land use estimates.
Waller, et al. (1984)	Coral Gables, FL	1. Commercial, Residential, Highway 2. Residential	Nutrients, Metals	Sampled 3 runoff events during March and April 1982 using ponded water collected in a low area. Insufficient data for estimation of loading rates. Data given as concentrations only.
Miller (1985)	Broward/Dade Counties, FL	1. Residential 2. Highway 3. Commercial 4. Apartment	Nutrients, Suspended Solids, Lead	Gives percent entrainment curves for various rain events. No actual concentration data or loading rate information supplied.
Yousef, et al. (1985)	Orlando, FL	Interstate Highway (I-4)	General Parameters, Nutrients, Metals	Runoff collected from roadside swales during 17 storm events from 1982-1983 using automatic collection equipment. Data presented as both concentration and loading rates. Limited to highway land use only. Presents data on pollutant removal efficiencies of swales.
Harper, et al. (1985)	Sanford, FL	54 acres low-density residential area	General Parameters, Nutrients, Metals	Flow-weighted composite runoff samples collected for 22 storm events during 1984. Grass swales with raised inlets used for conveyance and treatment. Data presented as both concentration and loading rates. Detailed hydrologic and watershed information. Presence of swale drainage/treatment system limits usefulness for characterization data.
Harper (1985)	Orlando, FL	Highway runoff (ADT = 16,000) 4.0-acre watershed	Heavy Metals	Flow-weighted runoff samples collected at inlet to wet detention pond during 16 storm events from April 1983-May 1984 with a wide range of total rainfall and antecedent rainfall conditions. No pre-treatment. Data presented as concentration only. Detailed hydrologic and rain event characteristics provided. Data used to evaluate fate of heavy metals.
Martin, et al. (1985)	Orange County, FL	Mixed use basin: 33% forest, 27% urban roadway, 27% high-density residential, and 13% low-density residential	General Parameters, Nutrients, Metals	Study provides evaluation of performance efficiency of a detention pond-wetlands system. No actual characterization data provided.

TABLE 4-3 -- CONTINUED

SUMMARY OF SELECTED STORMWATER CHARACTERIZATION STUDIES PERFORMED IN THE STATE OF FLORIDA

REFERENCE	LOCATION OF STUDY AREA	LAND USE TYPE	PARAMETERS MEASURED	COMMENTS
Howie, et al. (1986)	Broward County, FL	Highway	Nutrients, Metals	A total of 12 storm events were sampled from May to November 1983. Samples were collected from swale flow and do not reflect direct runoff. Surficial aquifer also sampled.
Yousef, et al. (1986)	Orlando, FL	Interstate Highway (I-4)	General Parameters, Nutrients, Metals	Flow-weighted composite runoff samples collected over 13-month period in 1982-1983 using automatic equipment. Event mean concentrations given for measured parameters. Hydrologic data provided could be used to generate loading rates. Study limited to highway use only.
Fall (1987)	Upper St. Johns River Basin	222,486 acres of primarily agriculture (70% pasture, 5% row crops)	General Parameters, Nutrients, Metals	Collection of 58 pumped discharge samples from 9 pumps from 1982-1987. Pumped discharges were not necessarily related to storm events. Data summarized by concentration only. No hydrologic data given for direct conversion to loading rates.
Fall, et al. (1987)	Indian River County, FL	27,720 acres agricultural basin (22,000 acres of citrus, remainder in pasture and drainage works)	General Parameters, Nutrients, Pesticides	Samples of pumped agricultural discharge collected monthly from November 1984 to November 1985. Results given in terms of concentration only. No hydrologic data provided.
Hendrickson (1987)	Brevard County, FL	5681 acres agricultural area, row crops and rangeland	General Parameters, Nutrients, Pesticides	A total of 87 samples of pumped agricultural discharge were collected during August to December 1986. Data given as concentration only. Loading rates may be determined using hydrologic data given. This represents a ditched agricultural area.
Harper (1988)	Central Florida Area	1. Interstate Highway 2. Residential 3. Commercial	General Parameters, Nutrients, BOD, Solids, Metals	Runoff collected from 5 watersheds during 8-12 storm events per watershed in 1987. Data presented in concentration form with hydrologic information on each watershed. Also gives removal efficiencies for stormwater management systems associated with each watershed along with groundwater effects.
Whalen, et al. (1988)	Various Locations Around U.S.	All General Types	General Parameters, Nutrients, BOD, Heavy Metals, Organics	Excellent summary report of runoff studies conducted primarily in Florida. Also presents data on effectiveness of stormwater management systems for pollutant removal.
Greg, et al. (1989)	Boca Raton, FL	Medium-density, residential (32.4 acres with 37% impervious)	Nutrients, Suspended Solids	Six runoff events were collected from 1985 to January 1986 using automatic equipment. Study includes detailed hydrologic information. Data given as concentration only, but could be converted to loading rate with information provided.

TABLE 4-3 -- CONTINUED

SUMMARY OF SELECTED STORMWATER CHARACTERIZATION STUDIES PERFORMED IN THE STATE OF FLORIDA

REFERENCE	LOCATION OF STUDY AREA	LAND USE TYPE	PARAMETERS MEASURED	COMMENTS
Harper and Herr (1993)	DeBary, FL	Low-intensity commercial, 50.7-acre watershed	General Parameters, Nutrients, Metals	
Harper and Herr (1994)	Orange County, FL	Single-family homes on one-acre lots	General Parameters, Nutrients, BOD, Suspended Solids, Metals	Four runoff events were collected from October 1993 to February 1994. Study includes hydrologic information. Data given as both concentration and areal loading rates.
Bahk (1997)	Ruskin, FL	Agriculture – row crops 210-acre watershed	General Parameters, Nutrients, Metals	Total of 18 grab samples collected from drainage ditch from Feb. 1992-Sept. 1995. Data as concentration only. Even though collected as grab samples, large sample size gives data usefulness. No hydrologic data provided.
Rushton, et al. (1997)	Tampa, FL	Mixed land use; 30% rooftops and asphalt parking; 6% limestone storage; and 64% grassed storage	General Parameters, Nutrients, Metals	Flow-weighted samples of pond inflow collected during 1993-1994.
ERD (2000)	Bradfordville – Tallahassee, FL	Low-intensity commercial; asphalt parking areas; inlets and stormsewers; 8-acre drainage basin	General Parameters, Nutrients, Demand Parameters	Flow-weighted composite samples collected during 12 storm events from Feb.-May 1999. Detailed hydrologic evaluation.
ERD (2000)	Bradfordville – Tallahassee, FL	Evaluated 3 separate areas: 1. 1.0-acre highway site on 6-lane divided highway 2. 16.8-acre single-family residential 3. 7.5-acre rural residential	General Parameters, Nutrients, Demand Parameters	Flow-weighted composite samples collected during 11 events at highway site, 5 events at rural residential site, and 7 events at single-family residential site. Good hydrologic data provided.
City of Tallahassee and ERD (2002)	Tallahassee, FL	1. High-intensity commercial 2. Light industrial 3. Recreation/open space 4. Multi-family residential 5. Low-density residential 6. Single-family residential	Nutrients, Demand Parameters, Metals	Flow-weighted composite samples collected at six land use characterization sites during 73 events from May 1999-March 2002. Data used to develop and calibrate area-wide pollutant loading model.
Rushton (2002)	Cockroach Bay - Tampa, FL	210-acre row crop area	General Parameters, Nutrients, Metals	Total of 85 runoff samples collected from 1998-2001 using automatic refrigerated samplers. Also contains extensive rainfall quality data.

TABLE 4-3 -- CONTINUED

SUMMARY OF SELECTED STORMWATER CHARACTERIZATION STUDIES PERFORMED IN THE STATE OF FLORIDA

REFERENCE	LOCATION OF STUDY AREA	LAND USE TYPE	PARAMETERS MEASURED	COMMENTS
ERD (2004)	Orlando, FL	Single-family residential; 2 separate sub-basins: 52.9-acre and 19.4 acre	General Parameters, Nutrients, Demand Parameters	Flow-weighted composite samples collected during 25 storm events at one site and 8 events at the other site from June-Sept. 2003.
Rushton (2004)	Temple Terrace, FL	132.4-acre mixed use basin including high-intensity commercial, multi-family residential, and golf course	General Parameters, Nutrients, Metals, Bacteria	Data collected as part of performance evaluation for a CDS unit. Excellent hydrologic data. Extensive water quality data for both inflow and outflow.
Teague, et al. (2005)	Florida Aquarium – Tampa, FL	11.25-acre parking lot; combination of asphalt, cement, and pervious pavement	Nutrients, Metals	Flow-weighted samples collected during 56 storm events using refrigerated auto-sampler from 2000-2003.
ERD (2005) Unpublished Data	Orlando, FL	6.5-acre watershed centered along U.S. 441, 6-8 lane asphalt highway	General Parameters, Nutrients, Metals	Flow-weighted samples collected during 23 storm events using refrigerated auto-sampler from April-August 2004.
ERD (2007)	Winter Haven	43.9-acre basin with light industrial and warehouse land use	General Parameters, Nutrients	Flow-weighted samples collected during 10 storm events using auto-sampler from October 2005-March 2006.
ERD (2007)	Windermere	95.4-acre basin, single-family, dirt roads with grassed swales	General Parameters, Nutrients	Flow-weighted samples collected during 14 storm events using auto-sampler from October 2005-March 2006.

A large number of stormwater monitoring studies have been conducted within the State of Florida as part of the NPDES Program. Stormwater samples collected as part of this program are restricted to a well defined range of rainfall depths and antecedent dry period conditions. Although this information may be useful in comparing runoff characteristics between major metropolitan areas, the sampling protocols required by this program do not necessarily provide accurate estimates of the average annual runoff concentrations for a given pollutant discharging from various land use categories. These values can only be estimated by monitoring a wide range of rainfall depths and antecedent dry period conditions. As a result, data collected as part of the NPDES Program are not utilized to estimate runoff characteristics for the purposes of this evaluation.

Studies included in development of stormwater characterization data cover the period from 1977-2005. Runoff concentrations of many parameters appear to be relatively consistent for a particular land use over this period with the exception of lead. Concentrations of lead in studies conducted prior to 1980-1990 are generally much greater than post 1980-1990 studies, presumably due to reductions of lead content in gasoline over this same period. Recent research conducted by ERD indicates that concentrations of total lead in stormwater runoff measured since 1990 are substantially lower than values measured prior to 1990. Therefore, it is assumed that lead concentrations presented in pre-1990 studies are not representative of current conditions and are not included in estimation of mean runoff characteristics of lead.

In general, the objective of the literature review is to provide estimates of event mean concentrations (emc) for each study included in the stormwater characterization database. When applied on an annual basis, the event mean concentration is defined as follows:

$$emc = \frac{\text{total annual pollutant load for a given parameter}}{\text{total annual runoff volume}}$$

In essence, this value reflects a flow-weighted average concentration for a given parameter over an annual cycle. When the emc is multiplied by the estimated total annual runoff volume, it provides an estimate of the annual mass loading discharging from the evaluated land use category for a given pollutant.

4.1.2 Single-Family Residential

Single-family residential land use is defined as a typical detached home with lot sizes generally less than 1 acre and dwelling densities greater than 1 dwelling unit per acre. Duplexes constructed on one-third to one-half acre lots are also included in this category. This type of land use is characterized by a moderate degree of impervious area, generally ranging from approximately 20-40%. Hydrologic characteristics for the identified single-family residential stormwater characterization studies are given in Table B.1 (Appendix B). Watershed areas for the identified characterization studies range from 7.39-897 acres, with impervious percentages ranging from 6.1-65.0%.

A summary of mean stormwater characteristics from single-family residential stormwater studies is given in Table 4-4. Each of the studies included in Table 4-4 provide characterization data for total nitrogen and total phosphorus. However, nutrient concentrations measured at the Orlando Duplex site by Harper (1988) appear to be substantially elevated, particularly when compared with total phosphorus values measured at the remaining sites. The measured emc of 1.69 mg/l for total phosphorus at this site is a clear outlier in the data set and is not included in estimation of the mean emc values for total phosphorus. The total nitrogen emc of 4.62 mg/l at this site also appears to be elevated but is not a clear outlier value. Therefore, this value is retained for estimation of the mean emc for total nitrogen. Total nitrogen emc values range from 1.02-4.62 mg/l, with an overall mean of 2.07 mg/l. Total phosphorus emc values range from 0.102-0.510 mg/l, with an overall mean of 0.327 mg/l. All but one of the listed studies provides characterization data for BOD, with 13 of the 17 studies including information for TSS.

TABLE 4-4

**SUMMARY OF MEAN STORMWATER CHARACTERISTICS
FROM SINGLE-FAMILY RESIDENTIAL STORMWATER STUDIES**

LOCATION	REFERENCE	MEAN emc VALUE (mg/l)										
		TN	TP	BOD	TSS	Cd	Cr	Cu	Fe	Ni	Pb	Zn
Pompano Beach	Matraw, et al. (1981)	2.00	0.310	7.9	26.0	--	--	0.008	0.298	--	0.167 ¹	0.086
Tampa - Charter Street	U.S. EPA (1983)	2.31	0.400	13.0	33.0	--	--	--	--	--	0.49 ¹	0.053
Maitland (3 basins)	German (1983)	2.20	0.340	7.1	43.0	--	--	0.014	0.350	0.008	0.230 ¹	0.016
St. Pete - Bear Creek	Lopez, et al. (1984)	1.50	0.200	4.7	--	--	--	0.009	--	--	0.128 ¹	0.083
Tampa - Kirby Street	Lopez, et al. (1984)	2.20	0.250	4.5	--	--	--	--	--	--	0.050 ¹	--
Tampa - St. Louis Street Ditch	Lopez, et al. (1984)	3.00	0.450	6.1	--	--	--	0.016	--	--	0.213 ¹	0.133
Orlando Duplex	Harper (1988)	4.62	1.69 ¹	9.5	63.2	0.005	0.015	0.033	0.464	0.020	0.058 ¹	0.089
Orlando - Essex Pointe	Harper (1988)	1.85	0.20	6.5	30.1	0.002	0.017	0.027	0.420	0.029	0.132 ¹	0.045
Springhill Subdivision, Palm Beach	Greg, et al. (1989)	1.18	0.307	--	3.5	--	--	--	--	--	--	--
Tampa - 102 nd Avenue	Holtkamp (1998)	2.62	0.510	13.4	36.8	--	--	0.019	--	--	0.005	0.060
Bradfordville, FL	ERD (2000)	1.30	0.280	2.7	57.1	--	--	--	--	--	--	--
Key Colony, Florida Keys	ERD (2002)	1.20	0.281	2.0	26.9	0.0015	0.0025	0.010	0.067	--	0.001	0.020
Tallahassee - Woodgate Subdivision	COT and ERD (2002)	1.29	0.505	15.0	76.0	--	--	0.007	--	--	0.007	0.039
Sarasota County	ERD (2004)	1.17	0.506	4.4	10.1	--	--	--	--	--	--	--
Orlando - Krueger St.	ERD (2004)	3.99	0.182	17.1	41.8	--	--	--	--	--	--	--
Orlando - Paseo Street	ERD (2004)	1.02	0.102	4.0	12.0	--	--	--	--	--	--	--
Windermere	ERD (2007)	1.69	0.402	--	65.0	--	--	--	--	--	--	--
Overall Mean Value		2.07	0.327	7.9	37.5	0.003	0.012	0.016	0.320	0.019	0.004	0.062

1. Data not included in calculation of mean value

Heavy metal characterization data from the residential land use studies is relatively limited, with the greatest amount of data available for copper, lead, and zinc. However, as discussed in Section 4.1.1, lead concentrations measured prior to 1990 are excluded from estimation of overall mean concentrations, substantially reducing the available data set for this parameter.

As seen in Table B.1, five of the 17 stormwater characterization sites utilize grassed swales exclusively for conveyance of stormwater runoff, while seven of the stormwater characterization sites use curb and gutter systems exclusively. The remaining sites use a combination of swale and curb and gutter systems. A comparison of runoff characteristics for residential sites utilizing grassed swales and curb/gutter drainage systems is given in Table 4-5. With the exception of total phosphorus, runoff characteristics collected from residential areas utilizing grassed swales appear to be substantially lower in value than observed for characterization sites utilizing curb and gutter systems. Overall, runoff collected from grassed swale drainage systems was approximately 38% lower for concentrations of total nitrogen, 48% lower for BOD, 46% lower for TSS, 47% lower for copper, and 23% lower for zinc than mean values measured at monitoring sites which utilized curb and gutter systems.

An analysis of variance comparison was conducted between the two data sets to determine if the observed differences in runoff concentrations between grassed swales and curb/gutter sites are statistically significant. This analysis was conducted only for total nitrogen, total phosphorus, BOD, TSS, copper, and zinc due to the limited data sets available for the other parameters. None of the differences in concentrations were found to be significant at a 95% probability level. However, the observed differences in total nitrogen concentrations were found to be statistically different at a 91% probability level, with a 77% probability level for significant differences in BOD concentrations, a 86% probability level for significant differences in TSS concentrations, and a 75% probability level for significant differences in copper concentrations. However, the overall number of data points available for this analysis is limited which makes detection of significant differences between the data sets more difficult.

TABLE 4-5

**COMPARISON OF RUNOFF CHARACTERISTICS FOR
RESIDENTIAL AREAS UTILIZING GRASSED SWALES AND
CURB / GUTTER DRAINAGE SYSTEMS**

a. Grassed Swales

LOCATION	REFERENCE	MEAN emc VALUE (mg/l)										
		TN	TP	BOD	TSS	Cd	Cr	Cu	Fe	Ni	Pb	Zn
Pompano Beach	Matraw, et al. (1981)	2.00	0.310	7.9	26.0	--	--	0.008	0.298	--	0.167 ¹	0.086
Palm Beach -Springhill Subdivision	Greg, et al. (1989)	1.18	0.307	--	3.5	--	--	--	--	--	--	--
Florida Keys- Key Colony	ERD (2002)	1.20	0.281	2.0	26.9	0.002	0.003	0.010	0.067	--	0.001	0.020
Sarasota County	ERD (2004)	1.17	0.506	4.4	10.1	--	--	--	--	--	--	--
Windermere	ERD (2007)	1.69	0.402	--	65.0	--	--	--	--	--	--	--
Overall Mean Value		1.45	0.361	4.8	26.3	0.002	0.003	0.009	0.183	--	0.001	0.053

b. Curb and Gutter

LOCATION	REFERENCE	MEAN emc VALUE (mg/l)										
		TN	TP	BOD	TSS	Cd	Cr	Cu	Fe	Ni	Pb	Zn
Tampa - Kirby Street	Lopez, et al. (1984)	2.20	0.250	4.5	--	--	--	--	--	--	0.050 ¹	--
Tampa - St. Louis Street Ditch	Lopez, et al. (1984)	3.00	0.450	6.1	--	--	--	0.016	--	--	0.213 ¹	0.133
Orlando - Essex Pointe	Harper (1988)	1.85	0.200	6.5	30.1	0.002	0.017	0.027	0.420	0.029	0.132 ¹	0.045
Tampa - 102 nd Avenue	Holtkamp (1998)	2.62	0.510	13.4	36.8	--	--	0.019	--	--	0.005	0.060
Bradfordville, FL	ERD (2000)	1.30	0.280	2.7	57.1	--	--	--	--	--	--	--
Tallahassee - Woodgate Subdivision	COT and ERD (2002)	1.29	0.505	15.0	76.0	--	--	0.007	--	--	0.007	0.039
Orlando - Krueger St.	ERD (2004)	3.99	0.182	17.1	41.8	--	--	--	--	--	--	--
Overall Mean Value		2.32	0.340	9.3	48.4	0.002	0.017	0.017	0.420	0.029	0.006	0.069

1. Value not included in calculation of mean value

4.1.3 Multi-Family Residential

Multi-family residential land use consists primarily of apartments, condominiums, and cluster homes. In general, this land use contains a large degree of impervious surface, with impervious percentages often in excess of 50%. A summary of hydrologic parameters from the six identified multi-family residential stormwater characterization studies is given in Table B.2. Watershed areas for the selected studies range from 8.7-73.3 acres, with impervious percentages ranging from 61-74%. Each of these monitoring sites utilizes underground stormsewer systems.

A summary of mean stormwater emc values from multi-family residential stormwater studies is given in Table 4-6. Each of the six listed studies provides characterization data for total nitrogen and total phosphorus, with five of the studies also providing information on BOD and TSS. Information on heavy metals is extremely limited for this land use category, with mean values provided only for copper, lead, and zinc. Studies performed prior to 1990 are not included in estimation of mean values for lead concentrations.

In general, mean concentrations for total nitrogen, total phosphorus, BOD, and TSS from the multi-family studies are higher in concentration than mean values obtained from the single-family residential studies. The increases in runoff characteristics observed in multi-family residential areas are expected due to the larger degree of impervious area and the higher level of activity.

TABLE 4-6

**SUMMARY OF MEAN STORMWATER CHARACTERISTICS
FROM MULTI-FAMILY RESIDENTIAL STORMWATER STUDIES**

LOCATION	REFERENCE	MEAN emc VALUE (mg/l)										
		TN	TP	BOD	TSS	Cd	Cr	Cu	Fe	Ni	Pb	Zn
Orlando - Shoals Apartments	ECFRPC (1978)	1.91	0.51	7.8	143	--	--	--	--	--	0.341 ¹	--
Miami - Kings Creek Apartments	Miller (1979)	2.57	0.45	14.5	36.8	--	--	--	--	--	0.054 ¹	0.059
Loch Lomond	Weinburg, et al. (1980)	1.91	0.73	--	--	--	--	--	--	--	--	--
Orlando - Downtown	Wanielista, et al. (1982)	4.68	0.72	10.1	95.6	--	--	--	--	--	--	--
Tampa - Young Apartments	U.S. EPA (1983)	1.61	0.33	16.0	53.0	--	--	--	--	--	0.076 ¹	0.060
Tallahassee - Royal Pavilion Apartments	COT and ERD (2002)	1.22	0.380	8.0	61.0	--	--	0.009	--	--	0.006	0.138
Overall Mean Value		2.32	0.52	11.3	77.8	--	--	0.009	--	--	0.006	0.086

1. Data not included in calculation of mean value

4.1.4 Low-Density Residential (Rural)

Low-density residential land use is defined as a rural type community with lot sizes generally greater than one acre and less than one dwelling unit per acre. These areas are typically characterized by low traffic volumes and runoff coefficients along with relatively low pollutant loading rates. The majority of these land areas are pervious surfaces covered by grass or wooded areas with only a small percentage of impervious area.

Low-density rural residential land use is the only general land use category for which specific loading rate studies were not found during the literature search. However, this type of land use is basically a mixture of the categories of single-family residential and open space since vegetated areas in the low-density category are often left in a natural condition typical of open spaces. Therefore, for purposes of this evaluation, runoff characteristics for low-density residential areas are estimated as the arithmetic mean of the mean values for single family residential (Table 4-4) and open space (Table 4-12).

4.1.5 Low-Intensity Commercial Areas

For the purposes of this evaluation, the term intensity refers to the level of use of the commercial area rather than an indication of the type of business or density of development. Low-intensity commercial areas are defined as areas which receive only a moderate amount of traffic volume and where cars may be parked during the day for extended periods of time. Since most commercial activities themselves generate relatively little pollutant loading, the majority of pollutant deposition occurs as a result of automobiles and trucks operating within the commercial area. Low-intensity commercial areas include schools, churches, professional office sites, and small shopping centers. High-intensity commercial areas include downtown business districts and large regional shopping areas.

A summary of hydrologic characteristics from low-intensity commercial stormwater characterization studies is given in Table B.3. Nine separate studies were identified in the available literature, with watershed areas ranging from 2.17-50.70 acres. Percentage imperviousness for the commercial sites range from 60% to approximately 100%. Eight of the nine studies utilize curb and gutter stormsewer systems, with swales utilized for drainage conveyance at the Florida Aquarium site.

A summary of mean stormwater emc values from low-intensity commercial stormwater studies is given in Table 4-7. Characterization data for total nitrogen, total phosphorus, and TSS are provided for each of the nine studies, with eight of the nine studies providing characterization data for BOD. As observed in previous land use categories, characterization data for heavy metals is somewhat limited. In general, low-intensity commercial areas are characterized by relatively low levels of total nitrogen, total phosphorus, and BOD, although TSS concentrations are somewhat elevated. Runoff characteristics reported by Harper and Herr (1993) are not included in calculation of the mean value since the runoff in this study received pre-treatment in a vegetated swale prior to collection.

TABLE 4-7

**SUMMARY OF MEAN STORMWATER CHARACTERISTICS
FROM LOW-INTENSITY COMMERCIAL STORMWATER STUDIES**

LOCATION	REFERENCE	MEAN emc VALUE (mg/l)										
		TN	TP	BOD	TSS	Cd	Cr	Cu	Fe	Ni	Pb	Zn
Orlando Areawide Study ¹	ECFRPC (1978)	0.89	0.16	3.6	146	--	--	--	--	--	0.068 ²	--
Ft. Lauderdale - Coral Ridge Mall	Miller (1979)	1.10	0.10	5.4	45.0	--	--	0.015	--	--	0.387 ²	0.128
Tampa - Norma Park	U.S. EPA (1983)	1.19	0.15	12.0	22.0	--	--	--	--	--	0.046 ²	0.037
Orlando - International Market Place	Harper (1988)	1.53	0.19	11.6	111	0.008	0.013	0.031	1.10	0.028	0.136 ²	0.168
DeBary ³	Harper and Herr (1993)	0.761	0.260	6.9	79.1	0.0005	0.003	0.010	0.582	--	0.009	0.028
Bradfordville	ERD (2000)	2.14	0.160	9.0	38.3	--	--	--	--	--	--	--
Tallahassee - Cross Creek Shopping Center	COT and ERD (2002)	0.925	0.15	8.0	15.0	--	--	0.008	--	--	0.002	0.045
Sarasota County	ERD (2004)	0.88	0.31	4.3	39.9	--	--	--	--	--	--	--
Florida Aquarium - Tampa	Teague, et al. (2005)	0.761	0.215	--	42.4	0.003	--	0.019	1.17	--	0.008	0.090
Overall Mean Value		1.18	0.179	7.7	57.5	0.006	0.013	0.018	1.14	0.028	0.005	0.094

1. Average of studies performed on a parking lot, motel complex, and commercial strip development
2. Data not included in calculation of mean value
3. Values excluded from means due to swale pre-treatment

4.1.6 High-Intensity Commercial Areas

High-intensity commercial land use consists of commercial areas with high traffic volume and relatively constant traffic moving into and out of the area. For purposes of this evaluation, high-intensity commercial areas include downtown business districts and large regional shopping areas. This land use category is typically characterized by a high degree of imperviousness, with values often in excess of 90%.

A summary of hydrologic characteristics from high-intensity commercial stormwater studies in Florida is given in Table B.4. Watershed sizes for the characterization studies range from 28-83 acres, with impervious percentages ranging from 96.4-98%. Four separate studies were obtained from the literature search which includes a regional shopping mall, a downtown commercial area, and commercial areas with heavy traffic volume.

A summary of mean stormwater emc values from high-intensity commercial stormwater studies is given in Table 4-8. Each of the four studies provides characterization data for total nitrogen and total phosphorus, while only half of the studies provide characterization data for BOD and TSS. Each of the studies also provides characterization information for lead and zinc, although all of the studies which provide data for lead were performed prior to 1990 and not useful for estimating current lead characteristics in runoff. As seen in Table 4-8, runoff characteristics from high-intensity commercial areas are substantially higher for virtually all evaluated parameters than observed in the low-density commercial studies.

TABLE 4-8

**SUMMARY OF MEAN STORMWATER CHARACTERISTICS
FROM HIGH-INTENSITY COMMERCIAL STORMWATER STUDIES**

LOCATION	REFERENCE	MEAN emc VALUE (mg/l)										
		TN	TP	BOD	TSS	Cd	Cr	Cu	Fe	Ni	Pb	Zn
Broward County	Matraw, et al. (1981)	1.10	0.10	5.4	45.0	0.009	--	0.015	0.334	--	0.387 ¹	0.128
Orlando - Downtown Area	Wanielista (1982)	2.81	0.31	17.2	94.3	--	--	--	--	--	0.560 ¹	0.165
Dade County	Waller (1984)	3.53	0.82	--	--	--	--	--	--	--	0.187 ¹	0.183
Broward County	Howie, et al. (1986)	2.15	0.15	--	--	--	--	--	--	--	0.241 ¹	0.162
Overall Mean Value		2.40	0.345	11.3	69.7	0.009	--	0.015	0.334	--	--	0.160

1. Data not included in the calculation of mean value

4.1.7 Light Industrial

Information concerning stormwater characterization data from light industrial areas is very limited in the existing literature. Only three studies could be identified which specified industrial park land use. Two of these studies were performed during the 1980s, with the final study performed during 2002.

A summary of hydrologic characteristics from the industrial stormwater studies is given in Table B.5. Watershed area and percent impervious area are not available for two of the three studies, with only impervious percentage provided for the final study.

A summary of emc values from industrial land use areas is given in Table 4-9. In general, industrial areas are characterized by relatively low concentrations of total nitrogen and BOD, with more elevated concentrations of total phosphorus and TSS.

TABLE 4-9

**SUMMARY OF MEAN STORMWATER CHARACTERISTICS
FROM LIGHT INDUSTRIAL STORMWATER STUDIES**

LOCATION	REFERENCE	MEAN emc VALUE (mg/l)										
		TN	TP	BOD	TSS	Cd	Cr	Cu	Fe	Ni	Pb	Zn
Orlando Areawide Study	ECFRPC (1985)	1.42	0.31	9.1	102	--	--	--	--	--	--	--
Manatee County Southeast Area Study	CDM (1985)	1.18	0.15	--	--	--	--	--	--	--	--	--
Tallahassee	COT and ERD (2002)	1.09	0.090	6.0	18.0	--	--	0.003	--	--	0.002	0.057
Winter Haven	ERD (2007)	1.10	0.488	5.3	75.7	--	--	--	--	--	--	--
Overall Mean Value		1.20	0.260	6.8	65.2	--	--	0.003	--	--	0.002	0.057

1. Data not included in the calculation of mean value

4.1.8 Highway/Transportation

Highway/transportation land use consists primarily of major highway systems, such as interstate highways, expressways, and major state and federal highway systems. In general, highway systems included under this category are considered to be heavily traveled, with constant traffic movement throughout the day. This land use category is typically characterized by a high degree of imperviousness.

A summary of hydrologic information from highway/transportation stormwater characterization studies is given in Table B.6. Eleven runoff characterization studies were identified in the literature review, with watershed areas ranging from 1.3-58.3 acres and impervious percentages ranging from 36-100%. Approximately half of the studies represent interstate highway systems, with the remaining studies reflecting major 4- or 6-lane highways. All of the systems provide drainage by curb and gutter systems.

A summary of emc values from highway/transportation stormwater studies is given in Table 4-10. Each of the 11 studies provides information for total nitrogen and total phosphorus, with five studies providing information for BOD and eight studies providing information for TSS. A relatively large number of the studies also included measurements of heavy metals, including cadmium, chromium, copper, iron, nickel, lead, and zinc. In general, highway/ transportation stormwater appears to have moderate levels of total nitrogen, total phosphorus, and TSS, with a relatively low level for BOD. Stormwater concentrations of copper and zinc appear to be somewhat elevated compared with concentrations measured in other land use categories.

TABLE 4-10

**SUMMARY OF MEAN STORMWATER CHARACTERISTICS
FROM HIGHWAY / TRANSPORTATION STORMWATER STUDIES**

LOCATION	REFERENCE	MEAN emc VALUE (mg/l)										
		TN	TP	BOD	TSS	Cd	Cr	Cu	Fe	Ni	Pb	Zn
Broward County (6-lane)	Mattraw, et al. (1981)	0.96	0.08	9.0	15.0	0.007	--	0.007	0.207	--	0.282 ¹	0.090
I-95 Miami (Bridge)	McKenzie, et al. (1983)	3.20	0.16	--	42.0	0.001	0.010	0.040	--	--	0.590 ¹	0.330
Maitland	German (1983)	1.30	0.240	--	27.0	--	--	0.012	0.350	0.009	0.092 ¹	0.055
I-4 Maitland Interchange	Harper (1985)	1.40	0.17	--	--	0.0025	0.004	0.038	0.341	0.003	0.163 ¹	0.071
Maitland Blvd.	Yousef, et al. (1986)	1.40	0.17	--	--	0.0022	0.004	0.039	0.354	0.004	0.181 ¹	0.074
I-4 EPCOT Interchange	Yousef, et al. (1986)	3.16	0.42	--	--	0.0016	0.003	0.024	0.205	0.003	0.026 ¹	0.024
Winter Park I-4	Harper (1988)	1.60	0.23	6.9	34.0	0.008	0.013	0.050	1.120	0.046	0.224 ¹	0.170
Orlando I-4	Harper (1988)	2.15	0.550	4.2	66.5	0.008	0.014	0.067	1.450	0.020	0.343 ¹	0.272
Bayside Bridge - Tampa	Stoker (1996)	1.10	0.10	--	20.0	0.0001	0.003	0.008	0.530	0.003	0.011	0.050
Tallahassee	ERD (2000)	1.10	0.166	1.9	70.6	--	--	--	--	--	--	--
Orlando - U.S. 441	ERD (2005) - unpublished data	0.683	0.085	4.2	23.1	--	--	--	--	--	--	--
Overall Mean Value		1.64	0.22	5.2	37.3	0.004	0.007	0.032	0.570	0.013	0.011	0.126

1. Data not included in calculation of mean value

The mean stormwater characteristics summarized in Table 4-10 are intended for use only where highway/transportation is the dominant land use category in a particular area. As indicated previously, stormwater characteristics summarized in this table are most appropriate for expressways, interstate highway systems, and heavily traveled roadways. Roadways associated with other land use categories, such as residential, commercial, industrial, agriculture, open space, and mining/extractive, are included in the stormwater characteristics presented for each of these categories. Therefore, roadway areas for these land use types should not be evaluated separately since runoff generated on the roadway surfaces is mixed with runoff generated from the dominant land use category.

4.1.9 Agricultural Areas

Agricultural land use within Florida is extremely varied, both in terms of agricultural activities and soil types. Agricultural activities such as cattle grazing and row crops are commonly conducted on poorly drained soils which are characterized by a relatively high runoff potential. Citrus, however, requires well drained soils with a much lower runoff potential than those typically associated with grazing or row crop activities. For these reasons, a wide range of agricultural uses and characteristics must be considered to obtain representative emc values appropriate for specific agricultural activities. For purposes of this analysis, agricultural activities in Florida are divided into three primary categories, including pasture land, citrus, and row crops. Sufficient characterization data currently exists within the literature to provide separate runoff characteristics for each of these three categories.

4.1.9.1 Pasture Land Use

Three separate studies were identified in the literature review which provide runoff characterization data for pasture land use. A summary of hydrologic characteristics from these pasture land use studies is given in Table B.7. Watershed sizes for the evaluated areas range from 21.6-155,741 acres. Each of the three study sites occurred on relatively poorly drained soils.

A summary of emc values from pasture land use studies is given in Table 4-11. Runoff characterization data is provided in each of the three studies for total nitrogen and total phosphorus, with BOD and TSS provided in two of the three studies. Measurement of heavy metal concentrations was not conducted in any of the studies. In general, pasture land use appears to have runoff concentrations for total nitrogen, total phosphorus, and TSS which are substantially greater than concentrations observed in residential or commercial areas.

TABLE 4-11

**SUMMARY OF MEAN STORMWATER CHARACTERISTICS
FROM PASTURE LAND USE STORMWATER STUDIES**

LOCATION	REFERENCE	MEAN emc VALUE (mg/l)			
		TN	TP	BOD	TSS
St. Cloud	CH2M Hill (1977)	5.57	0.88	7.0	180
St. Johns River Basin	Fall (1987)	2.48	0.27	3.2	8.6
Ash Slough	Hendrickson (1987)	2.37	0.697	--	--
Overall Mean Values		3.47	0.616	5.1	94.3

A relatively large degree of variability appears to exist between runoff concentrations from the three pasture land use areas. These differences are particularly apparent in the measured runoff concentrations for total nitrogen, total phosphorus, and TSS in the St. Cloud study. The studies performed in the St. Johns River Basin and in Ash Slough present hydrologic and water quality data at the farm boundaries after transport through conveyance systems to the point of discharge from the farm. These measured values reflect the effects of pollutant uptake and attenuation during travel through conveyance systems such as canals or on-site detention ponds. This type of value is more representative of runoff characteristics which actually discharge from large farm basin areas.

However, the St. Cloud study represents water quality data measured directly as runoff from the field area prior to entering adjacent canals and ditches and, as a result, does not include pollutant uptake and deposition of suspended solids and nutrients within conveyance systems located within the farm. As a result, the total nitrogen, total phosphorus, and TSS values obtained at this site are substantially greater than those obtained at the other sites. Nevertheless, this value is included in estimation of mean values for pasture land use to account for pasture areas that discharge rapidly into off-site drainage systems.

4.1.9.2 Citrus Land Use

Seven runoff characterization studies involving citrus land use were identified during the literature review. Soil types represented in these studies are generally poorly drained soils, consisting of fine grain sands, peat, or muck. The water table elevations in most of these studies was controlled by furrows and lateral ditches to keep the root zone of the plants dry. A summary of hydrologic characteristics from the citrus land use studies is given in Table B.8. Watershed sizes included in the land use characterization studies range from 184-56,868 acres. Studies included in this category were conducted from 1987-1997.

A summary of emc values from the citrus land use studies is given in Table 4-12. Each of the seven studies provides characterization data for total nitrogen and total phosphorus, with two studies providing data for BOD, and five studies providing studies for TSS. Information on heavy metal characteristics from citrus land uses is extremely limited. In general, citrus land use appears to have moderate concentrations for total nitrogen and total phosphorus, with relatively low concentrations for BOD, TSS, and heavy metals.

TABLE 4-12

SUMMARY OF MEAN STORMWATER CHARACTERISTICS FROM CITRUS LAND USE STORMWATER STUDIES

LOCATION	REFERENCE	MEAN emc VALUE (mg/l)								
		TN	TP	BOD	TSS	Cd	Cr	Cu	Pb	Zn
St. Johns River Basin (Citrus/Row)	Fall (1987)	3.26	0.24	3.0	28.0	--	--	--	--	--
St. Johns Water Control District (Citrus/Pasture)	Fall, et al. (1987)	1.33	0.09	2.1	4.6	--	--	--	--	--
Armstrong Slough (Citrus/Pasture)	Hendrickson (1987)	1.57	0.09	--	--	--	--	--	--	--
Upper St. Johns River Basin	Fall (1990)	2.72	0.16	--	23.3	--	--	0.004	--	--
Gator Slough (Hendry/Collier Counties)	Sawka and Black (1993)	3.32	0.170	--	--	--	--	0.002	--	--
Upper St. Johns River Basin	Fall (1995)	2.31	0.45	--	20.1	--	--	--	--	--
Charlotte/DeSoto Counties (4 sites)	Bahk and Kehoe (1997)	1.15	0.08	--	1.69	0.0004	0.001	--	0.001	0.012
Overall Mean Values		2.24	0.183	2.55	15.5	0.0004	0.001	0.003	0.001	0.012

4.1.9.3 Row Crops Land Use

Eight separate studies were identified in the literature which provide stormwater characterization data for row crop activities. A summary of hydrologic characteristics from row crop stormwater studies in Florida is given in Table B.9. Watershed areas included in these studies range from 12-5680 acres, although half of the sites did not include information on the watershed area. Soil types included in the areas are a combination of sand and muck soils. Studies included for characterization of row crops were performed from 1987-2002.

A summary of emc values from row crop stormwater studies is given in Table 4-13. Each of the eight studies provide characterization data for total nitrogen and total phosphorus, with five of the studies providing information for TSS, and none of the studies providing information for BOD. Information on heavy metal characteristics is included in three of the eight studies. In general, nutrient concentrations measured in row crop areas appear to be similar to those observed in pasture land use areas, although measured TSS concentrations in row crop areas appear to be substantially lower than those observed in pasture areas.

TABLE 4-13

**SUMMARY OF MEAN STORMWATER CHARACTERISTICS
FROM ROW CROP STORMWATER STUDIES**

LOCATION	REFERENCE	MEAN emc VALUE (mg/l)										
		TN	TP	BOD	TSS	Cd	Cr	Cu	Fe	Ni	Pb	Zn
Willowbrook Farms	Hendrickson (1987)	2.68	0.562	--	--	--	--	--	--	--	--	--
Upper St. Johns River Basin	Fall (1987)	3.26	0.24	--	--	--	--	--	--	--	--	--
Upper St. Johns River Basin	Fall (1990)	4.73	0.43	--	37.4	--	--	--	--	--	--	--
Upper St. Johns River Basin	Fall (1995)	3.36	1.07	--	32.4	--	--	--	--	--	--	--
Manatee County (5 sites)	Bahk, et al. (1997)	1.45	0.500	--	7.0	0.0001	0.001	0.011	--	--	0.0008	0.017
Cockroach Bay (Ruskin, FL)	Bahk (1997)	1.57	0.51	--	--	0.0003	0.004	0.035	0.160	BDL	0.008	0.052
Upper St. Johns River Basin (3 sites)	Hendrickson (unpublished data)	2.26	0.163	--	4.9	--	--	--	--	--	--	--
Cockroach Bay (Ruskin, FL)	Rushton (2002)	1.85	1.265	--	17.4	0.0003	--	0.019	0.934	--	0.002	0.020
Overall Mean Values		2.65	0.593	--	19.8	0.0002	0.003	0.022	0.547	BDL	0.004	0.030

4.1.9.4 Comparison of Agricultural Characteristics

A comparison of emc values from pasture, citrus, and row crop agricultural activities is given in Table 4-14. Pasture land use appears to have the largest mean concentration for total nitrogen, total phosphorus, and TSS. The lowest concentrations for these parameters occur for citrus land use.

A category of general agriculture is also included in the final row of Table 4-14. This category simply reflects the arithmetic mean of the listed characteristics for pasture, citrus, and row crop activities and is intended as a generic representation of agricultural activities for use in studies where information on specific agricultural activities is not known.

TABLE 4-14**COMPARISON OF STORMWATER CONCENTRATIONS
FROM AGRICULTURAL ACTIVITIES IN FLORIDA**

LAND USE	MEAN emc VALUE (mg/l)			
	TN	TP	BOD	TSS
Pasture	3.47	0.616	5.1	94.3
Citrus	2.24	0.183	2.55	15.5
Row Crops	2.65	0.593	--	19.8
General Agriculture ¹	2.79	0.431	3.8	43.2

1. Mean of pasture, citrus, and row crop land uses

4.1.10 Undeveloped/Rangeland/Forest Land Use

The category of undeveloped/rangeland/forest land use includes open spaces and undeveloped land occupied by native vegetation, forests, and rangeland. These areas are typically characterized by little or no impervious area and a relatively low runoff potential throughout most of the year.

Five separate runoff characterization studies were identified which measured undeveloped, rangeland, or forest land use areas. A summary of hydrologic characteristics from these studies is given in Table B.10. The evaluated studies range from Tallahassee to Miami. However, information on watershed area is not provided for any of the studies since delineation of watersheds for natural areas is often difficult. Land use in the evaluated studies includes flatwood, rangeland, open spaces, and forests, and studies were conducted over the years from 1977-2004.

A summary of emc values from the undeveloped, rangeland, and forest stormwater studies is given in Table 4-15. Each of the five studies provides characterization data for total nitrogen and total phosphorus, with three studies providing data for BOD, and four studies providing data for TSS. Heavy metal characteristics for copper, lead, and zinc are included in only one study. In general, undeveloped, rangeland, and forest land uses are characterized by relatively low concentrations for each of the available parameters summarized in Table 4-15.

TABLE 4-15**SUMMARY OF MEAN STORMWATER CHARACTERISTICS
FROM UNDEVELOPED / RANGELAND / FOREST STORMWATER STUDIES**

LOCATION	REFERENCE	MEAN emc VALUE (mg/l)						
		TN	TP	BOD	TSS	Cu	Pb	Zn
Orlando ECFRPC	CH2M Hill (1977)	1.52	0.10	1.7	18.5	--	--	--
Miami	Waller (1982)	0.90	0.02	--	4.8	--	--	--
Boggy Creek Study	ECFRPC (1988)	1.47	0.07	--	--	--	--	--
Sarasota/Charlotte Counties	ERD (2004)	0.703	0.031	1.0	1.9	--	--	--
Overall Mean Value		1.15	0.055	1.4	8.4	--	--	--

1. Data not included in calculation of mean value

4.1.11 Mining/Extractive Land Use

The category of mining/extractive land use includes a wide variety of mining activities for resources such as phosphate, sand, gravel, clay, and shell. Very little information is available in the current literature concerning the runoff characteristics of this land use type with the exception of site-specific studies generated as a result of water quality violations and enforcement actions. The only reference which provides runoff characterization data for mining/extractive land use is the Boggy Creek Study by the East Central Florida Regional Planning Council (ECFRPC) in 1988. This study assumes that very little pollution is generated from the actual mining operation, and runoff characteristics primarily reflect contributions from access roads, parking areas, and office sites. This assumption appears reasonable for many types of mining activities which generally extract materials from isolated pit areas. A summary of hydrologic data from the ECFRPC study is given in Table B.11. Although the watershed size is not presented in the study, the percentage of impervious area is estimated to be 23%.

A summary of stormwater emc values from mining/extractive land use studies is given in Table 4-16. Information is provided in the Boggy Creek study only for total nitrogen and total phosphorus, with a mean total nitrogen concentration of 1.18 mg/l and a mean total phosphorus concentration of 0.15 mg/l.

TABLE 4-16

**SUMMARY OF MEAN STORMWATER CHARACTERISTICS
FROM MINING / EXTRACTIVE STORMWATER STUDIES**

LOCATION	REFERENCE	MEAN emc VALUE (mg/l)						
		TN	TP	BOD	TSS	Cu	Pb	Zn
Boggy Creek Study	ECFRPC (1988)	1.18	0.15	--	--	--	--	--
Overall Mean Value		1.18	0.15	--	--	--	--	--

1. Data not included in calculation of mean value

4.1.12 Wetlands

Land uses assigned to the category of wetlands include a wide range of diverse wetland types, such as hardwood wetlands, cypress stands, grassed wetlands, and mixed wetland associations. Wetland systems are routinely included in ongoing monitoring efforts, and wetland characterization data is available throughout the State of Florida for a variety of wetland types.

When wetland characterization data is required, it is best to obtain regionally-specific data for the type of wetland system being evaluated. Wetland characterization is available through STORET, water management districts, FDEP, and local governmental monitoring agencies.

The hydrology of wetlands can be extremely complex, varying from flow-through wetlands which discharge throughout much of the year, to depressional wetlands which discharge infrequently. When including wetlands in pollutant loading evaluations, the site-specific hydrologic characteristics of the wetlands under evaluation must be considered. As a result of the complexities of wetland systems, guidelines concerning representative concentrations and hydrologic characteristics of wetlands are not included in this analysis.

4.1.13 Open Water/Lakes

The final land use category, open water/lakes, consists of open waterbodies such as lakes, reservoirs, streams, and rivers. Pollutant concentrations from these sources are a result of discharges from the waterbody during and following rain events. The discharge from the waterbody is a mixture of runoff contributed from the surrounding watershed and the ambient water quality characteristics of the waterbody. Waterbodies often provide pollutant attenuation for watershed areas which are tributary to the waterbody.

Characterization data is currently available for a large number of waterbodies located within the State of Florida. These data are easily available through STORET, the LAKEWATCH Program at the University of Florida, water management districts, FDEP, and local governmental agencies. In many cases, specific water quality data may be available for larger waterbodies which may be included in a pollutant loading analysis. Due to the abundant availability of site-specific data, recommendations on representative water quality characteristics for open water/lake land uses are not provided in this analysis.

4.1.14 Recommended Characterization Data

A summary of literature-based runoff characterization data for general land use categories in Florida is given in Table 4-17 based upon the information provided in the previous sections. The values summarized in this table represent the mean emc values for each of the general land use categories discussed previously.

In general, the data summarized in Table 4-17 reflect a pattern of increasing runoff concentrations with increasing land use intensity. Of the three types of residential land uses summarized in Table 4-17, the lowest emc values are associated with low-density residential. Increases in emc values occur when the land use intensity is increased to single-family residential, and further increases occur as the intensity is increased to multi-family. A similar pattern is apparent between low- and high-intensity commercial areas, with higher emc values reflected for high-intensity commercial areas for each of the listed parameters. Land use categories which are not expected to be a significant source of nitrogen or phosphorus loadings, such as industrial and highway areas, are characterized by relatively low concentrations for these parameters. In contrast, agricultural areas, which would be expected to have elevated concentrations of nutrients, are characterized by higher concentrations of nutrients, particularly for total phosphorus.

TABLE 4-17

**SUMMARY OF LITERATURE-BASED RUNOFF
CHARACTERIZATION DATA FOR GENERAL LAND
USE CATEGORIES IN FLORIDA**

LAND USE CATEGORY	TYPICAL RUNOFF CONCENTRATION (mg/l)						
	TOTAL N	TOTAL P	BOD	TSS	COPPER	LEAD	ZINC
Low-Density Residential ¹	1.61	0.191	4.7	23.0	0.008 ⁴	0.002 ⁴	0.031 ⁴
Single-Family	2.07	0.327	7.9	37.5	0.016	0.004	0.062
Multi-Family	2.32	0.520	11.3	77.8	0.009	0.006	0.086
Low-Intensity Commercial	1.18	0.179	7.7	57.5	0.018	0.005	0.094
High-Intensity Commercial	2.40	0.345	11.3	69.7	0.015	--	0.160
Light Industrial	1.20	0.260	7.6	60.0	0.003	0.002	0.057
Highway	1.64	0.220	5.2	37.3	0.032	0.011	0.126
<u>Agricultural</u>							
Pasture	3.47	0.616	5.1	94.3	--	--	--
Citrus	2.24	0.183	2.55	15.5	0.003	0.001	0.012
Row Crops	2.65	0.593	--	19.8	0.022	0.004	0.030
General Agriculture ²	2.79	0.431	3.8	43.2	0.013	0.003	0.021
Undeveloped / Rangeland / Forest	1.15	0.055	1.4	8.4	--	--	--
Mining / Extractive	1.18	0.15	7.6 ³	60.0 ³	0.003 ³	0.002 ³	0.057 ³

1. Average of single-family and undeveloped loading rates
2. Mean of pasture, citrus, and row crop land uses
3. Runoff concentrations assumed equal to industrial values for these parameters
4. Value assumed to be equal to 50% of single-family concentration

The mean runoff characteristics summarized in Table 4-17 are recommended for use in general runoff characterization and loading studies within the State of Florida. However, in areas where more site-specific runoff characterization information is available, the site-specific data should be used instead of the generalized data summarized in Table 4-17.

Several assumptions were made in assigning runoff concentrations to provide a more complete database for the general land use categories. First, runoff characterization data was not available for copper, lead, or zinc in low-density residential land uses in the literature. Therefore, to provide estimates of runoff characteristics for these parameters, typical concentrations of copper, lead, and zinc in low-density residential areas are assumed to be equal to 50% of the mean values listed for single-family residential. Heavy metal concentrations were also not available for copper, lead, or zinc for mining/extractive land uses. As a result, runoff concentrations for these parameters in mining/extractive areas are assumed to be similar to concentrations observed in industrial areas. Pollutant contributions from mining activities are generated primarily from the movement of trucks and automobiles along access roads into and out of the site, as well as parking lots and garages. These activities are very similar to those occurring in industrial areas.

4.2 Estimation of Runoff Quantities

Estimates of annual and event-based runoff volumes were calculated to evaluate variability in regional runoff generation and the performance efficiencies of dry retention systems. These calculations were performed using the SCS (Soil Conservation Service) Curve Number Methodology and the historical rainfall data sets for meteorological sites discussed in Section 4.1. A discussion of the methodology and results of this modeling is given in the following sections.

4.2.1 Methodology

The SCS curve number methodology utilizes separate calculations for the runoff volume generated from directly connected impervious areas (DCIA) and non-DCIA areas. An impervious area is considered to be directly connected if runoff from the area flows directly into the drainage conveyance system, such as a gutter or stormsewer. Areas are also considered to be directly connected if runoff from the area occurs as a concentrated shallow flow that is conveyed through a pervious area, such as a roadside swale, and then into a drainage system. The SCS curve number method assumes that after allotting for initial abstraction, all rainfall which occurs on directly connected impervious areas becomes stormwater runoff.

Non-directly connected impervious areas (non-DCIA) include all pervious areas and portions of impervious areas which are not considered to be directly connected. The SCS model assumes that runoff generated in these areas has the opportunity to infiltrate into the soil, depending upon the soil types and land cover characteristics, before significant runoff volumes begin to be generated within the area. The runoff generating characteristics of non-DCIA areas are quantified through the use of a curve number (CN). A curve number is a hydrologic factor which is used to reflect the runoff potential of a particular land use and soil type. Theoretical values for curve numbers range from 0-100, with low values reflecting a low runoff potential and higher values reflecting a high runoff potential. Representative curve numbers can be obtained from a variety of sources, although the original source of these data was published by the Natural Resources Conservation Service (NRCS) as Technical Release 55 titled "Urban Hydrology for Small Watersheds" dated June 1986. This reference provides an extensive listing of curve numbers for different hydrologic soil groups and land use covers.

The TR 55 document divides soil groups within the United States into Hydrologic Soil Groups (HSG) which groups general soil types with respect to runoff-producing characteristics. A summary of the characteristics of the designated hydrologic soil groups, identified as A, B, C, and D, is given in Table 4-18. The primary consideration in assigning soils to the general soil group types is the inherent capacity of the bare soil to permit infiltration. Soils classified in HSG A consist primarily of deep sandy soils, with a high infiltration rate and a low runoff potential. The vast majority of rainfall which occurs in these areas is absorbed by infiltration and does not become stormwater runoff. Soils classified in HSG D consist of clayey-type soils or soils with a high organic content which exhibit a low infiltration rate and a high runoff potential. A large portion of the rainfall which occurs on soils in this classification ultimately becomes stormwater runoff.

TABLE 4-18
CHARACTERISTICS OF SCS HYDROLOGIC
SOIL GROUP CLASSIFICATIONS

SOIL GROUP	DESCRIPTION	RUNOFF POTENTIAL	MINIMUM INFILTRATION RATE (inches/hour)
A	Deep sandy soils	very low	0.30-0.45
B	Shallow sandy soils	low	0.15-0.30
C	Sandy soil with high clay or organic content	medium to high	0.05-0.15
D	Clayey soils	very high	0.00-0.05

The SCS method calculates the runoff volume for a given rainfall event by adding the rainfall excess (runoff) from the non-DCIA portion to the rainfall excess created from the DCIA portion of the land use. Rainfall excess from the non-DCIA areas is calculated using the following set of equations:

$$nDCIA \text{ CN} = \frac{CN * (100 - Imp) + 98 (Imp - DCIA)}{(100 - DCIA)}$$

$$\text{Soil Storage, } S = \left(\frac{1000}{nDCIA \text{ CN}} - 10 \right)$$

$$Q_{nDCIAi} = \frac{(P_i - 0.2S)^2}{(P_i + 0.8S)}$$

where:

- CN* = curve number for pervious area
- Imp* = percent impervious area
- DCIA* = percent directly connected impervious area
- nDCIA CN* = curve number for non-DCIA area
- P_i* = event rainfall
- Q_{nDCIAi}* = rainfall excess for non-DCIA for rainfall event

For the DCIA portion, rainfall excess is calculated using the following equation:

$$Q_{DCIA_i} = (P_i - 0.1)$$

When P_i is less than 0.1, Q_{DCIA_i} is equal to zero. This factor reflects the initial abstraction for the impervious areas which assumes that the first 0.1 inch of rainfall is stored within the irregularities in the impervious surfaces and does not become stormwater runoff. After these surfaces become filled with the initial 0.1 inch of rainfall, additional rainfall begins to generate runoff on these surfaces.

One of the primary objectives of the hydrologic modeling efforts conducted by ERD is to evaluate the impact of the variability in probability distributions of individual rain events throughout the State of Florida, as discussed in Section 3.2, on rainfall/runoff relationships, as characterized by variabilities in modeled runoff coefficients. The impacts of variability in the sizes of individual rain events can best be evaluated using a continuous simulation hydrologic model which evaluates rainfall/runoff relationships over an extended period of time. However, this type of continuous modeling cannot be adequately conducted using rainfall data summarized on a daily basis. A portion of the 111 NCDC meteorological stations within the State of Florida also provide precipitation records which are summarized on an hourly basis. A listing of NCDC hourly precipitation monitoring stations in Florida is given in Table 4-19. Hourly precipitation data is available from 45 separate monitoring stations, with a period of hourly rainfall data ranging from 13-64 years.

All available hourly precipitation data was obtained for each of the 45 monitoring stations listed in Table 4-19. For each site, a continuous simulation was conducted of rainfall/runoff relationships using the entire record of hourly precipitation data for each site based on the SCS curve number method. This modeling included a mean of approximately 4685 individual rain events for each of the 45 monitoring stations. A location map for the 45 hourly precipitation monitoring sites is given on Figure 4-1.

The pervious area curve number values listed in engineering texts and reference manuals, used to estimate the amount of runoff lost due to infiltration into the soil during a rain event, reflect a “normal” antecedent moisture condition at the time of the rain event. These curve number values are commonly used for modeling design storm events (25- or 100-year storms) for developed areas where soil infiltration is a relatively insignificant loss in comparison with the overall volume of runoff generated during these design storm events. However, when performing continuous simulation modeling, the soil moisture condition at the time of the rain event can have a significant impact on the runoff volume generated from pervious areas. The Soil Conservation Service (SCS) has developed three antecedent soil moisture conditions to account for variability in runoff generation as a function of antecedent rainfall conditions. These three antecedent soil moisture conditions are labeled I, II, and III and are identified as follows:

- Condition I: Little significant rainfall during previous 5-day period; soils are dry
- Condition II: Average conditions
- Condition III: Heavy rainfall, or light rainfall and low temperatures have occurred within the past 5 days; soils are saturated

TABLE 4-19
LISTING OF NCDC HOURLY PRECIPITATION
MONITORING STATIONS IN FLORIDA

STATION	NUMBER OF YEARS	NUMBER OF EVENTS	MEAN ANNUAL RAINFALL (inches)	MAXIMUM EVENT (inches)	MEAN EVENT (inches)
Apalachicola Municipal Airport (211)	49	5630	55.79	10.06	0.49
Crestview Radio WJSB (1984)	21	2700	64.16	11.20	0.50
Niceville (6240)	20	2112	62.74	12.00	0.59
Panacea 3 S (6828)	32	3137	58.62	12.19	0.60
Panama City 5 NE (6842)	35	3607	58.72	11.10	0.57
Pensacola Regional Airport (6997)	33	4165	62.17	13.93	0.49
Tallahassee Municipal Airport (8758)	45	5570	64.55	13.41	0.52
Avon Park 2 W (369)	27	2985	48.71	9.73	0.44
Branford (3543)	53	5644	52.27	11.89	0.49
Clewiston (1649)	35	3679	46.26	9.60	0.44
Deland 1 SSE (2229)	13	1527	53.95	11.30	0.46
Dowling Park 1 W (2391)	35	3468	51.42	9.00	0.52
Gainesville-Univ. of Florida (3316)	49	5162	50.04	8.69	0.48
Graceville 1 SW (3538)	32	3250	55.31	10.30	0.54
Kissimmee 2 (4625)	25	2747	45.85	15.62	0.42
Lakeland (4797)	53	6413	49.92	10.80	0.41
Leesburg (4980)	48	5071	48.03	8.77	0.45
Lynne (5237)	28	2936	48.97	7.80	0.47
Marineland (5391)	52	5336	47.04	10.85	0.46
Melbourne Regional Airport (5612)	47	5073	47.52	9.89	0.44
Moore Haven Lock 1 (5895)	43	4885	45.89	9.60	0.40
Orlando International Airport (6628)	62	7855	50.03	13.75	0.39
Raiford State Prison (7440)	30	3076	48.94	10.10	0.48
Tamiami Trail 40 mi (8780)	26	2968	52.13	9.20	0.46
Venus (9184)	39	4260	47.26	11.75	0.43
Woodruff Dam (9795)	27	2794	52.63	9.50	0.51
Key West WB City (4575)	63	8035	39.07	24.39	0.31
Lignumvitae Key (5035)	26	2521	40.92	8.30	0.42
Brooksville Chin Hil (1046)	50	5211	54.03	12.90	0.52
Cross City (2006)	47	4965	55.14	11.10	0.52
Daytona Beach Regional Airport (2158)	63	8019	49.61	11.46	0.39
Fort Myers-Page Field (3186)	28	3051	53.13	10.15	0.49
Inglis 3 E (4273)	48	4698	51.05	11.43	0.52
Jacksonville (4371)	64	8148	52.96	15.05	0.42
Lamont 6 WNW (4892)	45	4523	54.05	9.73	0.54
Parrish (6880)	44	4349	52.06	10.60	0.53
St. Leo (7851)	54	5619	52.90	11.84	0.51
St. Petersburg Whittd (7886)	45	4607	50.68	11.84	0.50
Tampa International Airport (8788)	47	5253	46.07	13.96	0.41
Vernon (9206)	16	1716	59.89	6.90	0.56
Boca Raton (845)	40	5527	60.10	14.00	0.43
Homestead Exp Stn (4091)	27	3687	58.39	18.00	0.43
Miami WSO City (5668)	64	10119	56.92	15.30	0.36
St. Lucie New Lock 1 (7859)	35	4688	54.82	10.66	0.41
West Palm Beach Intl Airport (9525)	64	10040	60.61	15.23	0.39
Mean:	40.6	4685	52.70	11.66	0.47

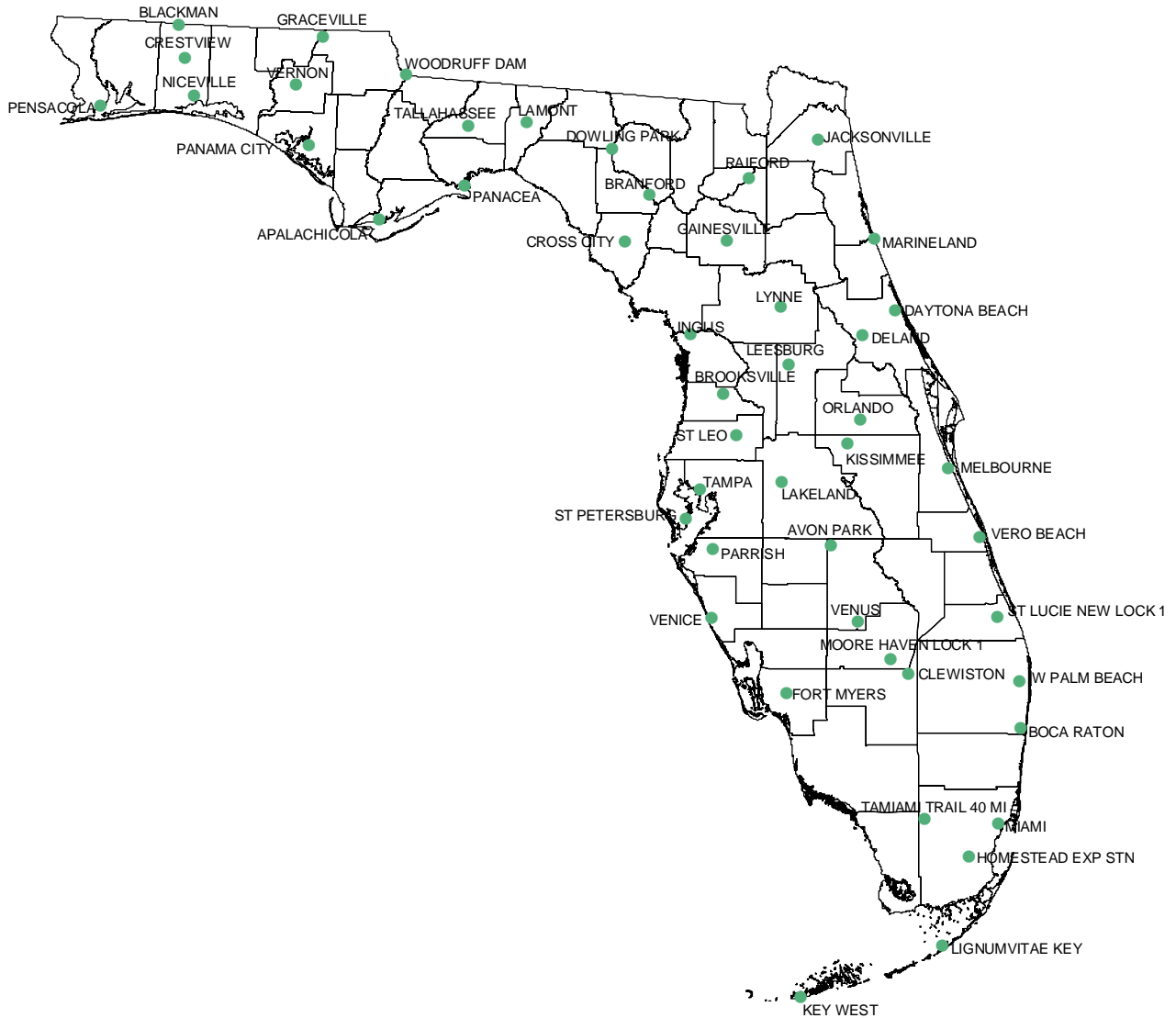

Figure 4-1. Locations of Hourly Meteorological Monitoring Sites.

The antecedent rainfall necessary to trigger AMC I or III conditions is based upon the rate at which the soil storage is recovered following a rain event. Loss of soil moisture occurs as a result of several processes, one of which is evapotranspiration. Evapotranspiration increases during the “growing” season and decreases during the “dormant” season. For Florida, the growing season is commonly assumed to be from March-September, and the dormant season from October-February.

Recommended rainfall depths corresponding to the three antecedent moisture conditions (AMC) are summarized in Table 4-20 (USDA, 1986) for both dormant and growing season conditions. Antecedent moisture conditions are determined by evaluating the total cumulative rainfall in the 5-day period prior to a selected rainfall event. During dormant season conditions, occurring from October-February, a cumulative antecedent 5-day rainfall less than 0.5 inches would indicate a shift to antecedent moisture Condition I for the new rain event. During growing season conditions, this value increases to 1.4 inches. However, if the total antecedent 5-day rainfall exceeds 1.1 inches during dormant season conditions, an antecedent moisture Condition III is assigned to the next rain event. Under growing season conditions, this value increases to 2.1 inches. When performing continuous simulations, the SCS recommends that the standard curve number value assumed for modeling purposes be modified to consider antecedent rainfall conditions.

TABLE 4-20
RECOMMENDED SEASONAL RAINFALL
DEPTHS FOR THE THREE ANTECEDENT
MOISTURE CONDITIONS (AMC)

AMC	TOTAL ANTECEDENT 5-DAY RAINFALL (inches)	
	DORMANT SEASON (October-February)	GROWING SEASON (March-September)
I	< 0.5	< 1.4
II	0.5-1.1	1.4-2.1
III	> 1.1	> 2.1

The tabular curve number values presented in textbooks and handbooks generally reflect antecedent moisture Condition II. These values can be modified to reflect either antecedent moisture Condition I or III, based upon the antecedent cumulative 5-day rainfall using the relationships summarized in Table 4-21 (McCuen, 1982). Mathematical expressions for these relationships have been developed by Chow, et al. (1988) as follows:

$$CN(I) = \frac{4.2 CN(II)}{10 - 0.058 CN(II)}$$

and

$$CN(III) = \frac{23 CN(II)}{10 + 0.13 CN(II)}$$

TABLE 4-21**RECOMMENDED CURVE NUMBER ADJUSTMENTS
BASED ON ANTECEDENT MOISTURE CONTENTS**

CN FOR CONDITION II	CORRESPONDING CN FOR CONDITION	
	I	III
100	100	100
95	87	99
90	78	98
85	70	97
80	63	94
75	57	91
70	51	87
65	45	83
60	40	79
55	35	75
50	31	70
45	27	65
40	23	60
35	19	55
30	15	50
25	12	45
20	9	39
15	7	33
10	4	26
5	2	17
0	0	0

Estimates of runoff depths were generated for each of the 45 hourly meteorological sites for a wide variety of directly connected impervious area (DCIA) and non-DCIA curve numbers. Runoff calculations were performed for combinations of DCIA values ranging from 0-100%, in 5% increments, and for non-DCIA curve numbers ranging from 30-95, in 5-unit increments, along with a non-DCIA curve number of 98. The calculated runoff depth for each combination of DCIA and non-DCIA curve number represents the total runoff generated for the assumed hydrologic characteristics over the entire period of record for a given site. The total runoff depth is then divided by the total rainfall depth which occurred over the entire period of record to generate a runoff C value for each combination of DCIA and curve number.

The runoff coefficient ranges from 0-1 and represents the ratio of runoff depth to the precipitation depth. The rated C Value is calculated using the following equation:

$$C \text{ Value} = \frac{\text{Generated Runoff (depth or volume)}}{\text{Total Rainfall (depth or volume)}}$$

Runoff C values can be calculated on either an event basis or for an annual period. The calculated C value for each combination of DCIA and curve number reflects the average runoff/rainfall ratio for a given meteorological monitoring site over the entire available period of record. The calculated runoff C value does not represent anticipated rainfall/runoff relationships for any given year, but does reflect anticipated runoff/rainfall relationships over an extended period of time for each site.

4.2.2 Impacts of Rainfall Distributions on Runoff Depth

The variability in frequency distributions of individual rain events, discussed in the previous section, has the potential to impact rainfall/runoff relationships for individual rain events as well as on an annual basis. Areas which have a large number of small rain events which generate little measurable runoff may have a lower annual runoff coefficient than a similar area in a different portion of the State which is characterized by a high frequency of large rain events which generate significant runoff.

The potential impacts of rainfall frequency distributions on runoff volumes were evaluated by conducting simulations of the annual runoff depth generated by typical residential and commercial developments constructed at various locations throughout the State. Eight separate undeveloped and developed land use categories were assumed to evaluate the impacts of rainfall distributions on annual runoff coefficients. A summary of hydrologic assumptions used for the developed land use categories is given in Table 4-22. The low-density residential areas are assumed to have approximately 15% impervious area, with 5% of the area as DCIA. Hydrologic characteristics are provided for single-family residential developments based on 25% impervious and 40% impervious conditions. High-density residential areas are assumed to be 65% impervious, with 80% impervious assumed for commercial activities. Curve numbers for pervious areas are also included based on soil types and assumptions regarding landscaped conditions. Highway land use categories are also included, based upon 50% and 75% impervious assumptions. Curve number values for pervious areas are provided for each of the four major hydrologic soil groups.

Estimates of the annual runoff depths generated by the land use categories summarized in Table 4-22 were calculated using the continuous simulation methodology outlined in Section 4.2.1 and the hydrologic characteristics summarized in Table 4-22. These estimates were calculated for each of the 45 NCDC hourly precipitation monitoring stations summarized in Table 4-19. This process resulted in a total of 1440 separate long-term continuous simulations by modeling annual long-term runoff coefficients for each of the eight land use types, four individual soil groups, and 45 monitoring stations. The calculated runoff coefficients for each combination of monitoring site, land use, and curve number reflect the average annual runoff coefficient for the modeled monitoring sites over the entire available period of record.

The runoff C values generated as a result of the process outlined above were evaluated using a K-means clustering algorithm to identify similarities and differences in annual runoff coefficients for each of the eight land use types and four soil groups across the State of Florida. The clustering algorithm attempts to minimize the squared error objective function, representing the distance measured between a data point and the center of a chosen cluster. Clustering is simply a method of partitioning a data set into sub-sets (clusters) so that the data in each sub-set are statistically similar for the evaluated common trait.

TABLE 4-22

**SUMMARY OF HYDROLOGIC ASSUMPTIONS
USED FOR DEVELOPED LAND USE CATEGORIES**

TYPICAL LAND USE	PERCENT TOTAL IMPERVIOUS AREA	% DCIA ¹	CURVE NUMBER (CN) FOR PERVIOUS AREAS			
			HSG A	HSG B	HSG C	HSG D
Low-Density Residential	15	5	49 ²	69 ²	79 ²	84 ²
Single-Family Residential						
a. 25% impervious	25	15	39 ³	61 ³	74 ³	80 ³
b. 40% impervious	40	25	39 ³	61 ³	74 ³	80 ³
High-Density Residential	65	50	39 ³	61 ³	74 ³	80 ³
Commercial	80	75	39 ³	61 ³	74 ³	80 ³
Highway ⁴						
a. 50% impervious	50	50	49 ²	69 ²	79 ²	84 ²
b. 75% impervious	75	75	49 ²	69 ²	79 ²	84 ²

1. Percentage of total project area
2. Assumes open space, lawns, or landscaping in fair condition
3. Assumes open space, lawns, or landscaping in good condition
4. Includes area within right-of-way

For this evaluation, cluster analysis was conducted for 2, 3, 4, 5, 6, 7, and 8 clusters. There is no standard technique to determine the optimum number of clusters which should be chosen to represent a particular data set. However, the elbow criterion is a common rule of thumb which is often used to determine the appropriate number of clusters to be selected. The elbow criterion indicates that you should select a number of clusters so that adding an additional cluster does not provide a significant amount of additional information in the model. This criterion is typically evaluated using the percentage of variance explained for each cluster model. A graph of the percentage of variance and annual runoff coefficients explained as a function of the number of clusters is given in Figure 4-2. As the curve begins to approach the 4- or 5-cluster models, the additional variance explained by adding an additional cluster to the model becomes incrementally small. Therefore, an appropriate number of clusters for the annual runoff coefficients model appears to be approximately 4 or 5. The 5-cluster analysis was selected as the final model because this model identified the Florida Keys as unique in terms of annual runoff coefficients compared with other areas throughout the State of Florida. ERD has conducted stormwater and meteorological monitoring throughout the State of Florida, including the Florida Keys, and has firsthand knowledge of the substantially different meteorological processes which occur within the Florida Keys compared with other areas within the State of Florida. As a result of this firsthand experience, the 5-cluster model was selected.

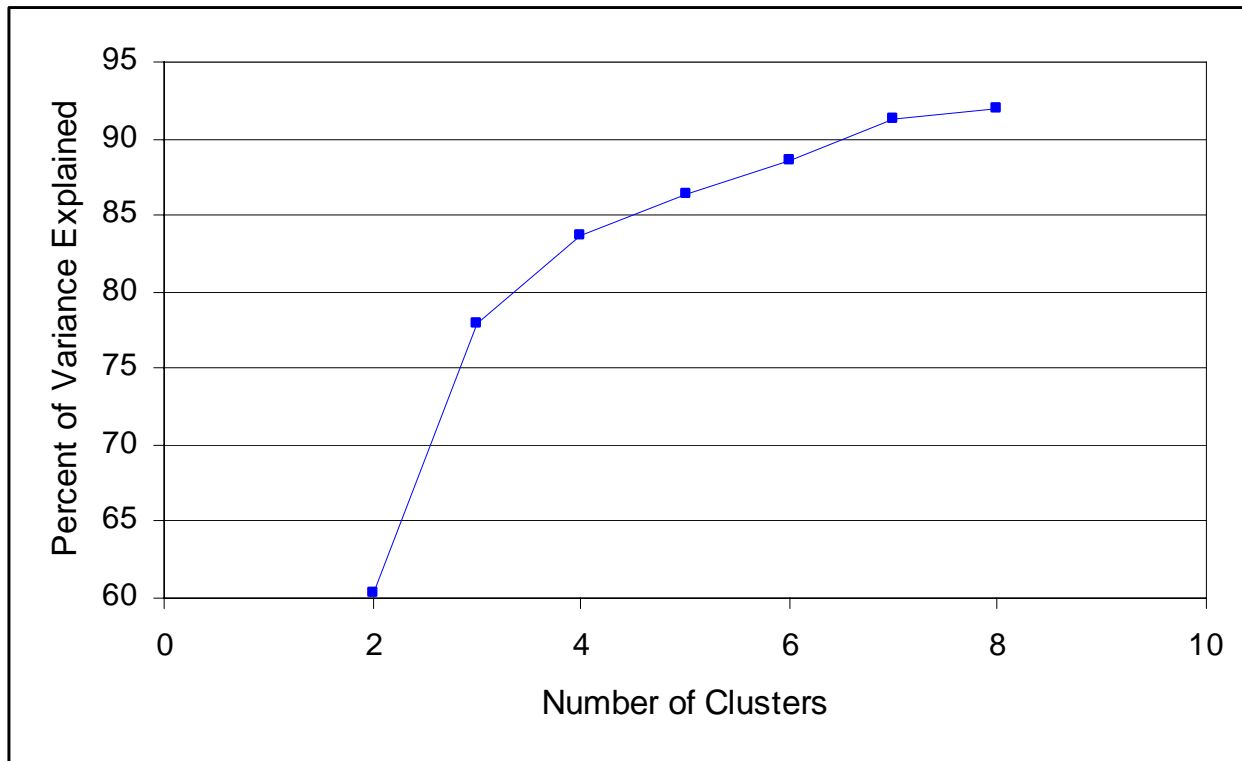

Figure 4-2. Percentage of Variance in Annual Runoff Coefficients Explained as a Function of the Number of Clusters.

A graphical summary of the results of the cluster analysis is given in Figure 4-3. Meteorological monitoring sites with similar runoff generating characteristics are grouped together by color on this figure. Approximate areas represented by the clustered meteorological monitoring sites are shaded in similar colors, generally on a County-wide basis. The majority of the indicated zones appear to be intuitive with respect to variability in rainfall events throughout the State. Portions of the Panhandle have been clustered together in an area which is impacted by a high number of large frontal events. Portions of the State along the Gulf Coast also appear to be similar runoff generating characteristics. Central and Central-Coastal portions of Florida also appear to have similar runoff characteristics. Runoff patterns in Southeast Florida appear to be dissimilar to rainfall patterns in other areas of the State. The Florida Keys are also identified on Figure 4-3 as a unique meteorological zone. The meteorological zones indicated on Figure 4-3 are utilized throughout the remainder of this report for evaluating runoff generation, pollutant loadings, and stormwater management system performance.

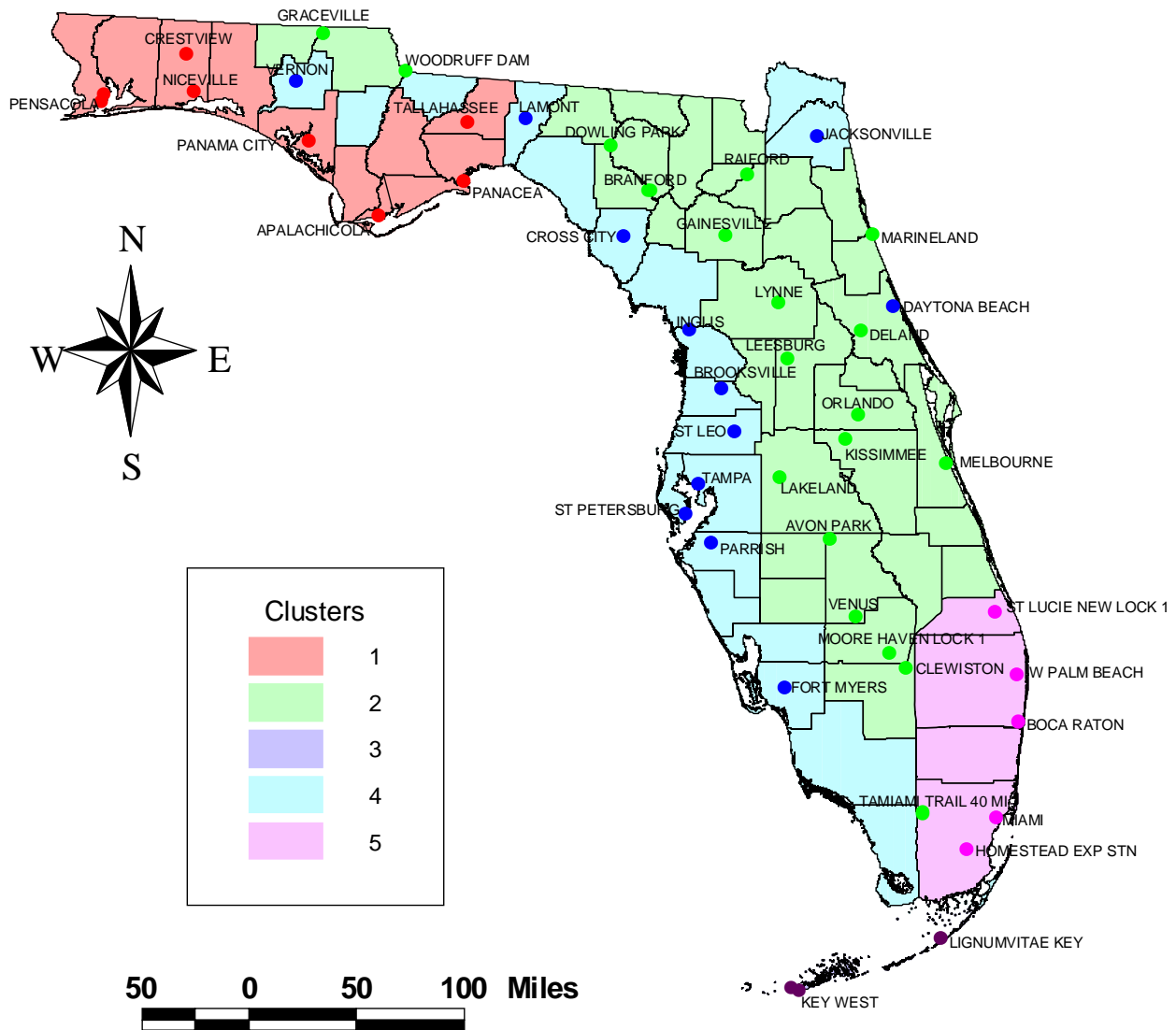

Figure 4-3. Meteorological Zones Identified Using Cluster Analysis.

Unfortunately, not all counties in Florida have long-term meteorological monitoring sites with hourly data. For purposes of designating meteorological zones, counties without a monitoring site were grouped according to the meteorological characteristics of adjacent counties with monitoring sites. The resulting zones appear to be relatively intuitive with respect to meteorological processes. The cluster groupings only have two apparent outliers, Daytona Beach and Tamiami Trail, which appear out of place. However, in a data set containing 45 points, an analysis conducted at a 95% probability level would be expected to have approximately 2-3 outlier values. A listing of counties included in each meteorological zone is given in Table 4-23.

TABLE 4-23
COUNTIES INCLUDED IN THE
DESIGNATED METEOROLOGICAL ZONES

ZONE				
1	2	3	4	5
Okaloosa	St. Lucie	Monroe	Washington	Martin
Liberty	Columbia		Manatee	Broward
Bay	DeSoto		Levy	Miami-Dade
Wakulla	St. Johns		Pasco	Palm Beach
Leon	Seminole		Pinellas	
Santarosa	Sumter		Lee	
Gulf	Flagler		Hillsborough	
Franklin	Suwannee		Hernando	
Escambia	Gadsden		Sarasota	
Walton	Gilchrist		Duval	
	Glades		Dixie	
	Calhoun		Collier	
	Hamilton		Citrus	
	Hardee		Charlotte	
	Hendry		Taylor	
	Union		Nassau	
	Highlands		Jefferson	
	Putnam		Monroe	
	Holmes			
	Indian River			
	Jackson			
	Volusia			
	Lafayette			
	Lake			
	Polk			
	Brevard			
	Bradford			
	Baker			
	Madison			
	Osceola			
	Marion			
	Orange			
	Clay			
	Okeechobee			
	Alachua			

A summary of mean runoff coefficients for each cluster as a function of land use and hydrologic soil group is given in Table 4-24. The values summarized in this table reflect the mean runoff coefficients for each land use and hydrologic soil group and each meteorological monitoring site included in each of the five clusters. The values summarized in Table 4-24 reflect differences in runoff coefficients as a result of frequency distributions of common rain events only. This analysis does not include variability in rainfall depth throughout the State which must be multiplied times the mean runoff coefficients to obtain an estimate of annual runoff volume.

TABLE 4-24

**SUMMARY OF MEAN RUNOFF COEFFICIENTS
FOR EACH CLUSTER AS A FUNCTION OF LAND
USE AND HYDROLOGIC SOIL GROUP**

LAND USE	HYDROLOGIC SOIL GROUP	CLUSTER				
		1	2	3	4	5
Undeveloped Land	A	0.015	0.007	0.013	0.011	0.018
	B	0.064	0.039	0.052	0.050	0.067
	C	0.126	0.087	0.103	0.105	0.127
	D	0.176	0.128	0.143	0.149	0.173
Low-Density Residential Areas	A	0.092	0.069	0.081	0.079	0.093
	B	0.166	0.126	0.140	0.144	0.164
	C	0.238	0.187	0.200	0.210	0.232
	D	0.294	0.237	0.248	0.262	0.284
Single-Family Residential Areas (25% Impervious)	A	0.155	0.136	0.143	0.144	0.151
	B	0.206	0.173	0.184	0.188	0.202
	C	0.268	0.223	0.235	0.243	0.260
	D	0.313	0.262	0.272	0.285	0.302
Single-Family Residential Areas (40% Impervious)	A	0.245	0.220	0.227	0.231	0.237
	B	0.294	0.257	0.266	0.273	0.284
	C	0.350	0.303	0.312	0.324	0.337
	D	0.391	0.339	0.347	0.362	0.375
High-Density Residential Areas	A	0.455	0.423	0.424	0.436	0.435
	B	0.490	0.450	0.453	0.467	0.469
	C	0.529	0.483	0.485	0.503	0.506
	D	0.556	0.508	0.509	0.529	0.531
Commercial Areas	A	0.648	0.613	0.609	0.628	0.618
	B	0.664	0.625	0.622	0.642	0.633
	C	0.683	0.641	0.637	0.658	0.651
	D	0.697	0.653	0.649	0.671	0.664
Highway Areas (50% Impervious)	A	0.444	0.415	0.416	0.427	0.425
	B	0.481	0.442	0.445	0.459	0.460
	C	0.517	0.473	0.476	0.492	0.495
	D	0.546	0.498	0.500	0.519	0.522
Highway Areas (75% Impervious)	A	0.647	0.612	0.608	0.627	0.616
	B	0.665	0.626	0.623	0.642	0.634
	C	0.683	0.641	0.638	0.659	0.651
	D	0.698	0.654	0.650	0.672	0.665

4.2.3 Annual Runoff Generation

A summary of calculated mean annual runoff coefficients as a function of curve number and DCIA is given in Appendix C for each of the five designated meteorological zones. The values presented in these tables reflect the proportion of annual rainfall which becomes stormwater runoff in each meteorological zone for 315 DCIA and non-DCIA curve number combinations. Continuous simulations of runoff generation were conducted over the period of record for each of the 45 hourly meteorological monitoring stations in Florida. Runoff calculations were performed for combinations of DCIA values ranging from 0-100%, in 5% increments, and for non-DCIA curve numbers ranging from 30-95, in 5 unit increments. A non-DCIA curve number of 98 was also included in this analysis. The mean runoff C value for each combination of DCIA and curve number value was calculated using values from each of the meteorological monitoring sites within a given zone. The values summarized in Appendix C reflect the average long-term runoff coefficients for each of the five designated zones over a wide range of DCIA and curve number combinations. The data summarized in Appendix C reflect a total of 14,175 separate long-term continuous simulations of runoff coefficients based upon the 21 DCIA intervals, 15 curve number intervals, and 45 meteorological monitoring sites. This information is used in subsequent sections for evaluation of existing stormwater design criteria and to evaluate the performance efficiency of proposed alternative regulations.

The information contained in Appendix C can be used to estimate the annual runoff volume for a given parcel under either pre- or post-development conditions by multiplying the mean annual rainfall depth for the given area, obtained from the Figures in Appendix A.3, times the appropriate runoff coefficient based upon the DCIA and curve number characteristics for the meteorological zone in which the parcel is located, listed in Appendix C. This estimate is calculated as follows:

$$\text{Annual Runoff Volume (ac-ft)} = \text{Area (acres)} \times \text{Mean Annual Rainfall (inches)} \times \text{C Value} \times \frac{1 \text{ ft}}{12 \text{ in}}$$

Linear interpolation can be used to estimate annual runoff coefficients for combinations of DCIA and curve number which fall between the values included in Appendix C.

As seen in Appendix C, a wide degree of variability is present in calculated annual runoff coefficients for various combinations of DCIA and non-DCIA curve numbers between the five meteorological zones in Florida. Increases in DCIA as well as increases in the non-DCIA curve number both result in significant increases in the calculated annual runoff coefficients. To illustrate the general relative relationships between DCIA, curve number, and annual runoff volumes, a set of average annual runoff coefficients was generated by calculating the mean runoff coefficient for each combination of DCIA and non-DCIA curve number for the five meteorological zones in Florida. A graphical summary of this relationship is given in Figure 4-4. This graph indicates a linear relationship between runoff coefficients and percent DCIA, with an exponential relationship between runoff coefficient and curve number. Increases in curve numbers, particularly at curve number values in excess of 80, result in substantial increases in the estimated annual runoff coefficient and corresponding annual runoff volume.

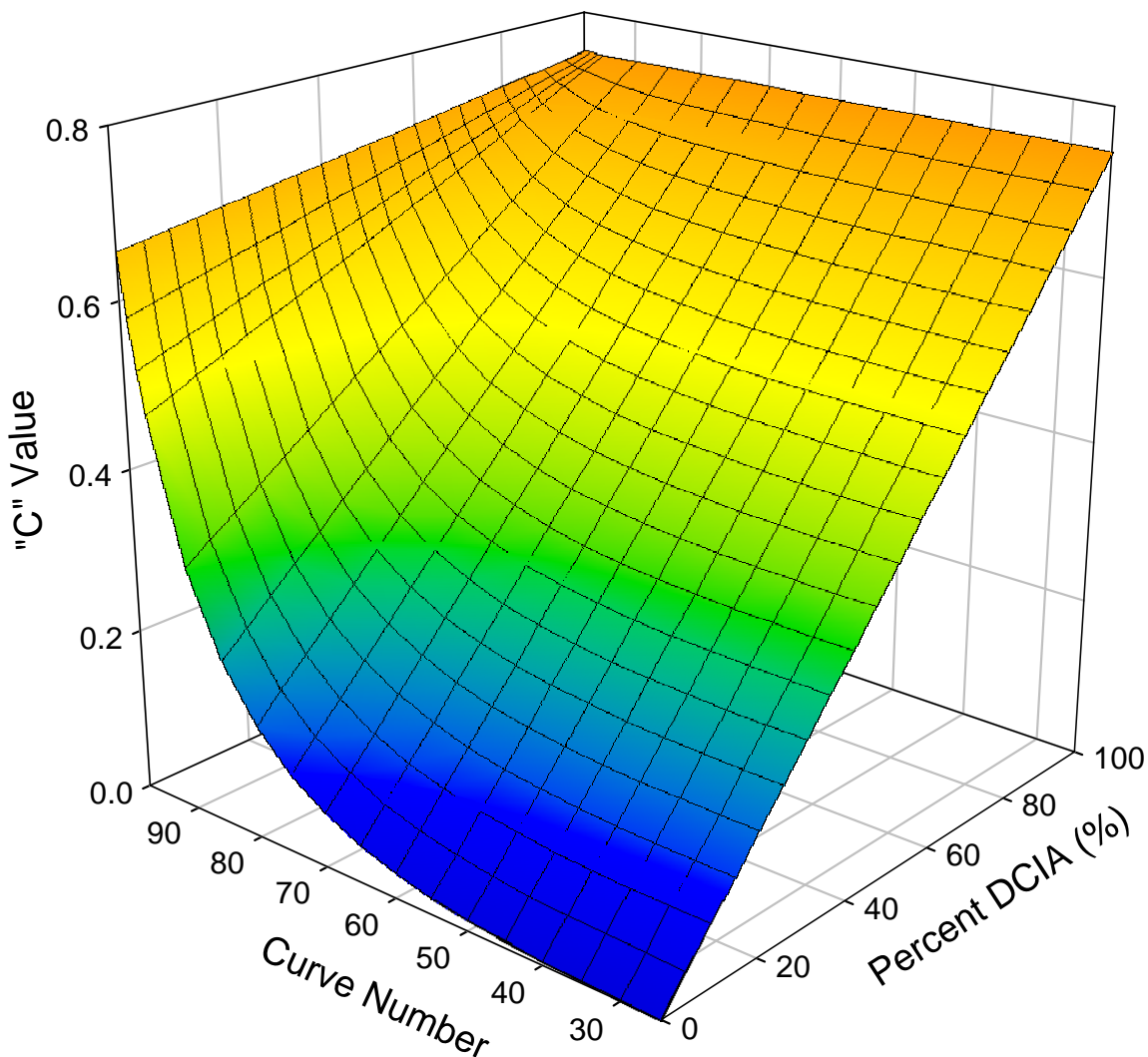

Figure 4-4. General Relationships Between Percent DCIA, Curve Number, and C Value.

A graphical illustration of the distribution of runoff coefficients as a function of DCIA and curve number for the Panhandle (Zone 1) rainfall distribution is given in Figure 4-5. In this meteorological region, DCIA appears to have a relatively small impact on runoff coefficient at DCIA percentages of 40 or less. However, at percentages above 40, the runoff coefficient appears to increase rapidly. Changes in curve number appear to have a minimal impact on runoff coefficients until the curve number begins to exceed approximately 85. Above this value, subsequent increases in curve number result in large increases in runoff coefficient.

Panhandle (Zone 1)

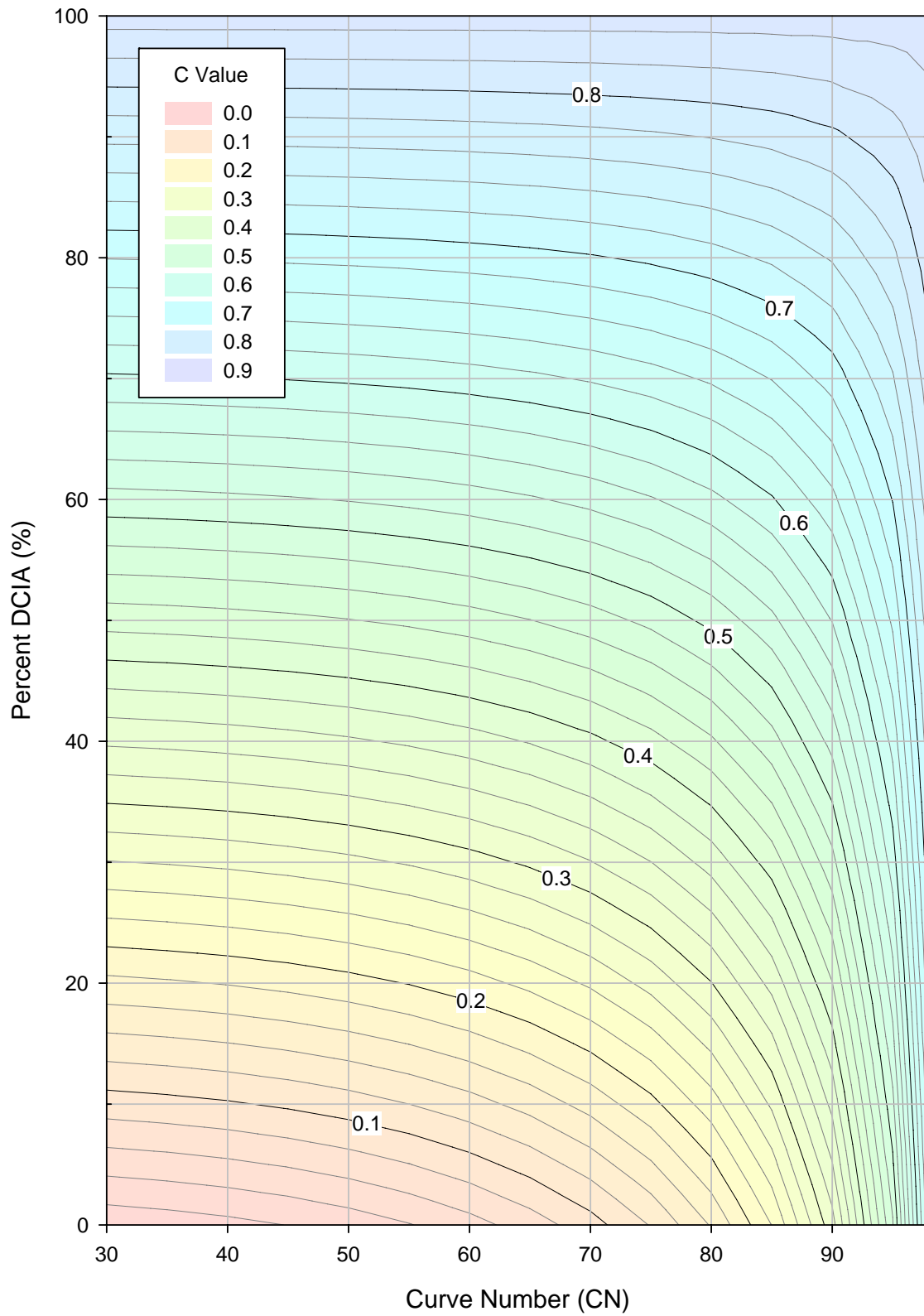

Figure 4-5. Distribution of C Values as a Function of DCIA and Curve Number for the Panhandle Area (Zone 1).

A graphical representation of the distribution of runoff coefficients as a function of DCIA and curve number for the Florida Keys meteorological zone is given in Figure 4-6. For this rainfall distribution, DCIA appears to have a relatively minimal impact on runoff coefficients until the DCIA begins to exceed a value of approximately 70. Above this value, subsequent increases in DCIA result in relatively large increases in runoff coefficients. Changes in curve number appear to have a relatively small impact on runoff coefficient until the curve number begins to exceed a value of approximately 95. Above this value, runoff coefficients begin to increase rapidly. The data presented in Figure 4-6 suggest that, for a given combination of DCIA and curve number, the runoff coefficient for the Florida Keys zone is substantially lower than the runoff coefficient which would occur in the Panhandle region.

A graphical representation of the state-wide mean distribution of runoff coefficients as a function of DCIA and curve number is given in Figure 4-7. This diagram represents the average of the five designated meteorological zones within the State. On a state-wide basis, significant changes in runoff volume do not occur until the DCIA value exceeds approximately 45-50 and the curve number exceeds 90.

For comparison purposes, modeled annual runoff coefficients for a hypothetical development with a DCIA of 40% and a non-DCIA curve number of 70 are given in Figure 4-8. If this development were to be constructed in the Florida Keys (Zone 3) or Central (Zone 2) portions of the State, approximately 36% of the annual rainfall would become stormwater runoff. However, if this development were to be constructed in the Panhandle area, approximately 39-40% of the annual rainfall would become stormwater runoff. On a state-wide average, approximately 37.5% of the rainfall which occurs on the hypothetical development would become stormwater runoff. Lower than average annual runoff coefficients would be observed in the Florida Keys (Zone 3), Central Area (Zone 2), and Gulf Coast Area (Zone 4), with higher runoff coefficients observed in the Panhandle (Zone 1) and Southeast Coastal (Zone 5).

The differences in annual runoff coefficients between the meteorological regions summarized in Figure 4-8 are due primarily to differences in the distribution of rain events which occur at each of these sites. For example, the Key West and Melbourne regional sites are characterized by a high percentage of annual events with a relatively low rainfall depth which generate little or no measurable runoff volume. Since a large portion of the annual rainfall in these areas is generated by small events, the net effect is to substantially decrease the annual runoff coefficient associated with these areas. On the other hand, the Pensacola and Tallahassee areas are characterized by a high percentage of larger storm events, commonly associated with frontal boundaries which move through the area. Since larger rain events typically generate a larger proportion of stormwater runoff than smaller events, the annual runoff coefficients for these areas tend to be more elevated.

The results summarized in Figure 4-8 have significant implications with respect to the performance efficiency of stormwater management systems, particularly systems that have design criteria based on providing treatment for the runoff generated by a stated rainfall event. Based on the information summarized in Figure 4-8, a 1-inch rain event in the Panhandle area will generate more runoff than a 1-inch rain event which occurs in the Florida Keys or Central areas. This would create a substantial difference, not only in the required treatment volume, but also in the performance efficiency of a stormwater system designed for the same hypothetical development in the Panhandle and Florida Keys.

Florida Keys (Zone 3)

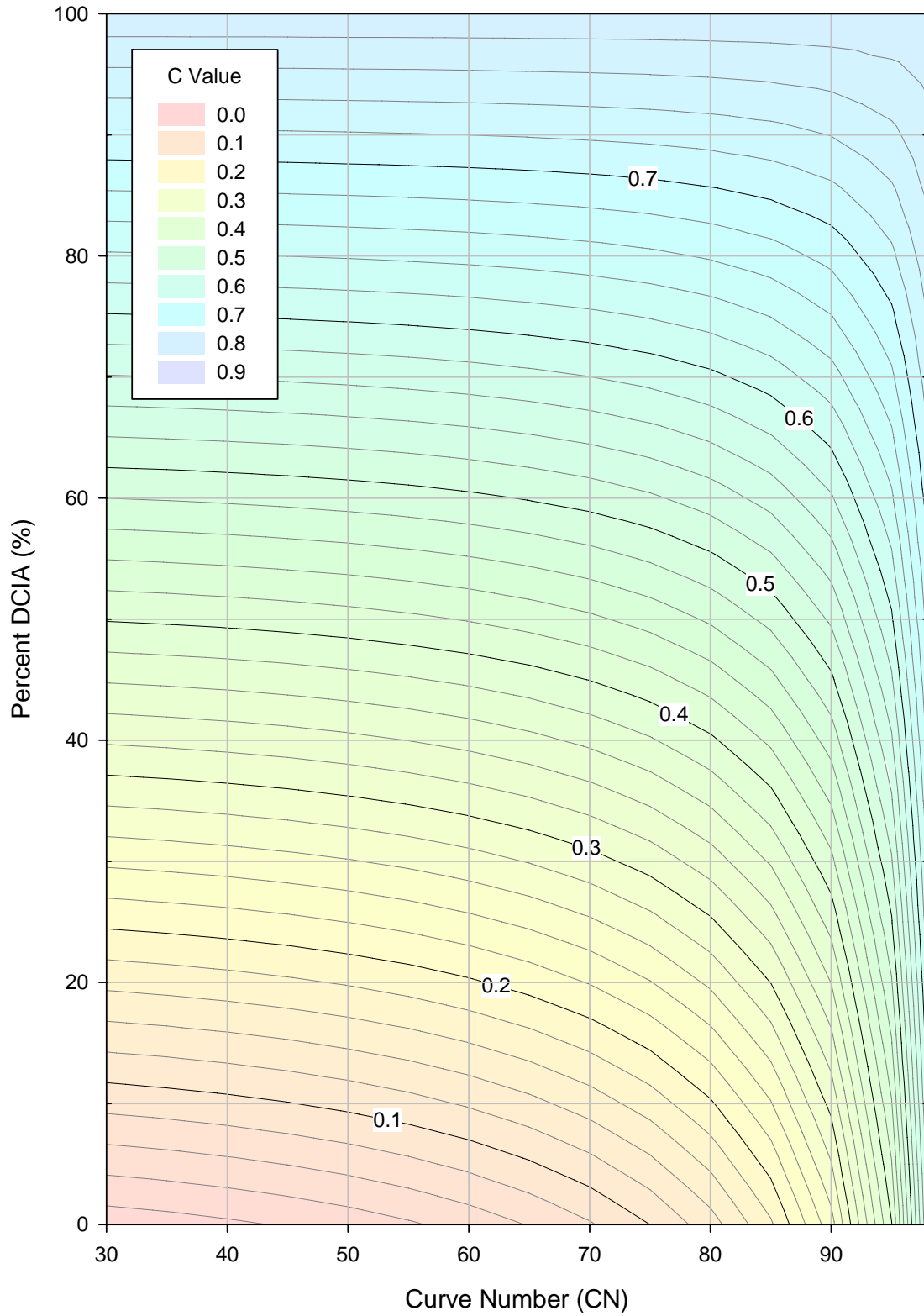

Figure 4-6. Distribution of C Values as a Function of DCIA and Curve Number for the Florida Keys (Zone 3).

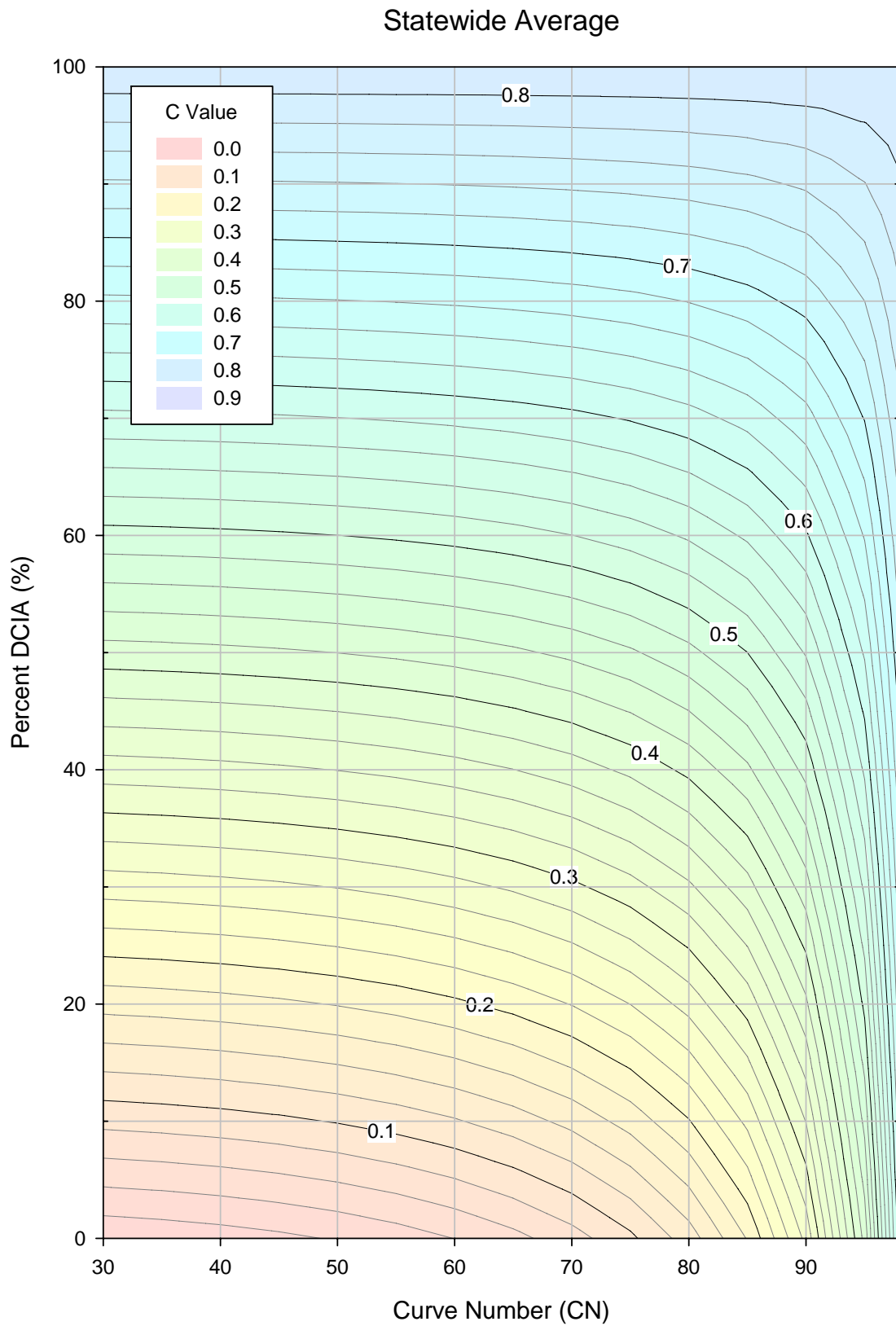

Figure 4-7. State-wide Mean Distribution of C Values as a Function of DCIA and Curve Number.

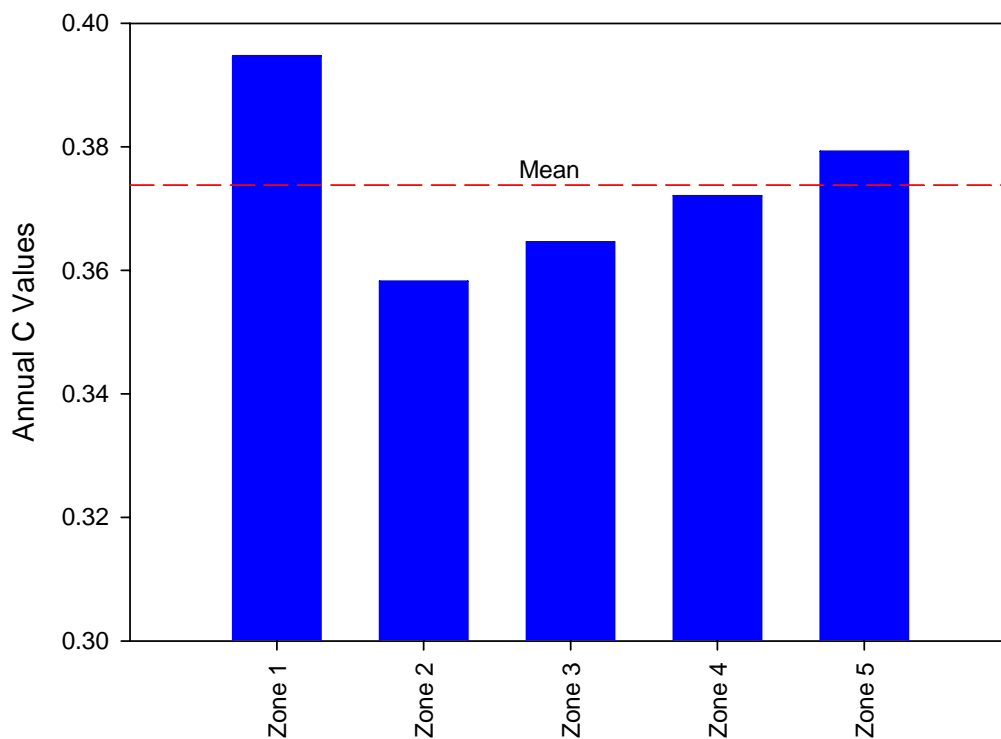

Figure 4-8. Modeled Annual Runoff Coefficients (C Values) for a Hypothetical Development with a DCIA of 40% and a non-DCIA Curve Number of 70.

The phenomenon illustrated in Figure 4-8 is explained primarily by the relative number of small and large rain events associated with the different meteorological regions within the State. For example, a comparison of the percentage of annual rainfall volume generated by rain events less than 0.1 inch at the designated meteorological regions is given in Figure 4-9. For the Florida Keys (Zone 3) sites, approximately 5-8% of the annual rainfall volume is contributed by rain events less than 0.1 inch in depth. Based upon the assumption that impervious surfaces provide an initial abstraction of approximately 0.1 inch, no measurable runoff would be measured by rain events of this size. In contrast, only approximately 3-6% of the annual rainfall volume in the Panhandle zone is contributed by rain events less than 0.1 inch in depth.

A comparison of the percentage of annual rainfall volume generated by rain events greater than 1 inch is given in Figure 4-10. Only approximately 49% of the annual rainfall volume which occurs in the Florida Keys (Zone 3) is generated by rain events greater than 1 inch. However, at the Panhandle sites (Zone 1), approximately 62% of the annual rainfall volume occurs as a result of events greater than 1 inch. Since larger rain events generate a proportionately larger runoff volume due to the lessening impact of initial abstraction, areas which have a higher proportion of large rain events can be expected to have a larger annual runoff coefficient.

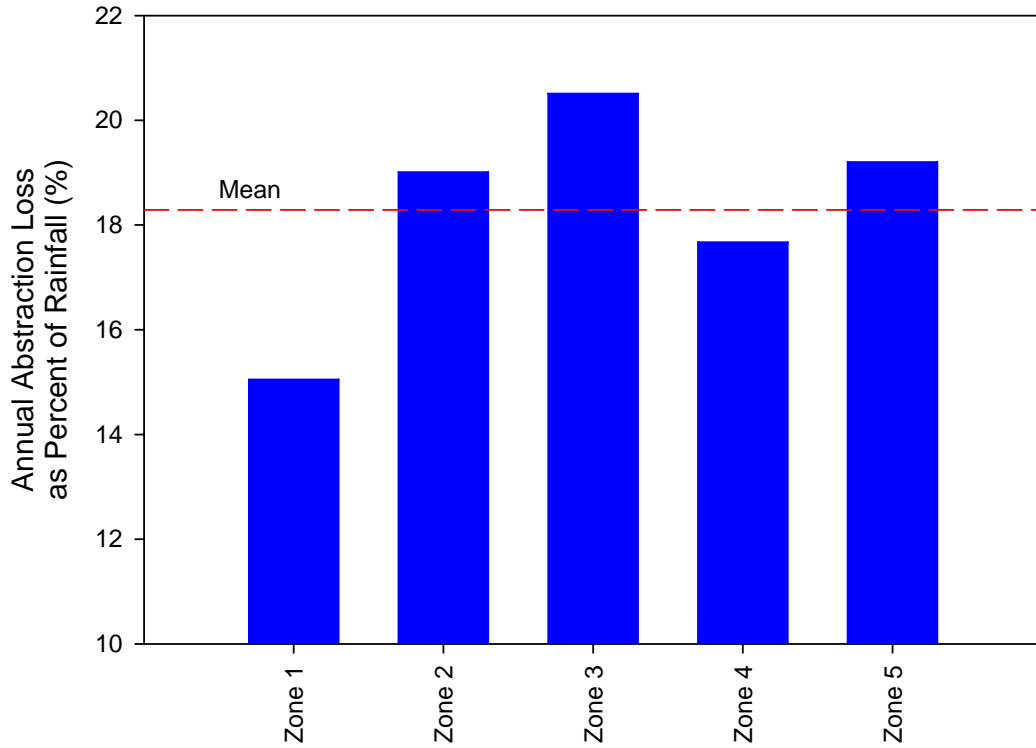

Figure 4-9. Percentage of Annual Rainfall Volume Generated by Rain Events < 0.1 Inch.

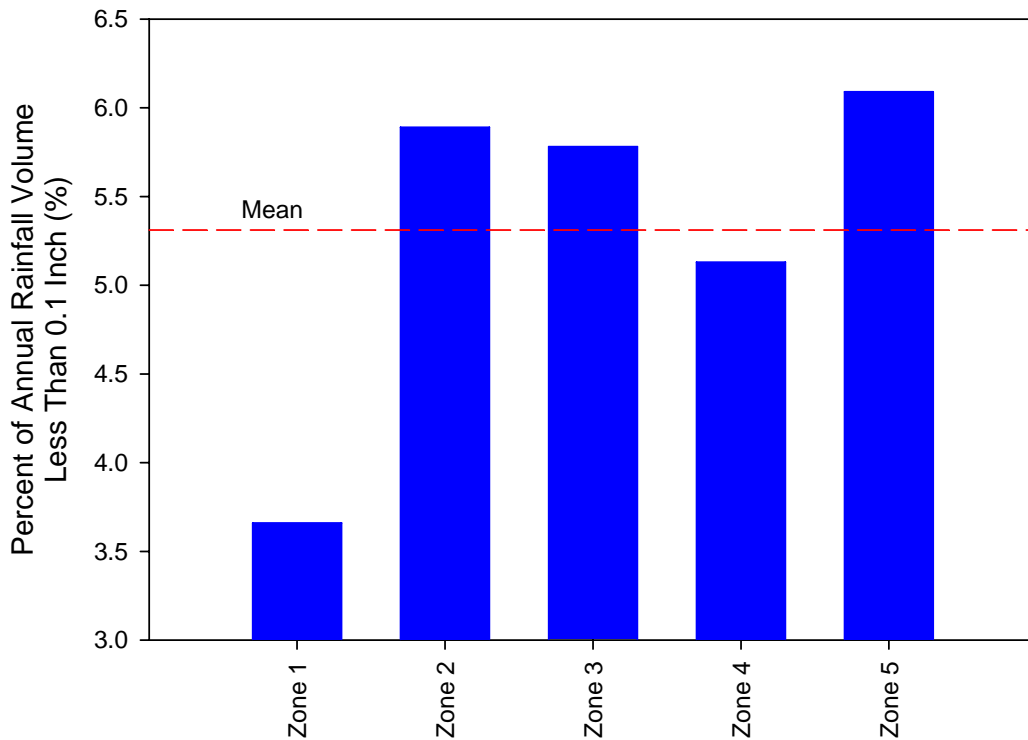

Figure 4-10. Percentage of Annual Rainfall Volume Generated by Rain Events >1 Inch.

A comparison of the percentage of annual rainfall depth lost to abstraction on impervious surfaces for each of the meteorological zones is given in Figure 4-11. In the Florida Keys (Zone 3) area, approximately 21% of the total annual rainfall which occurs on impervious surfaces is lost as a result of initial abstraction. This rainfall, which is stored on the surface of the impervious areas, is removed by evaporation processes between storm events. However, in the Panhandle (Zone 1) area, only 15% of the annual rainfall depth is lost to initial abstraction on impervious surfaces due to the higher percentage of large rain events in this portion of the State.

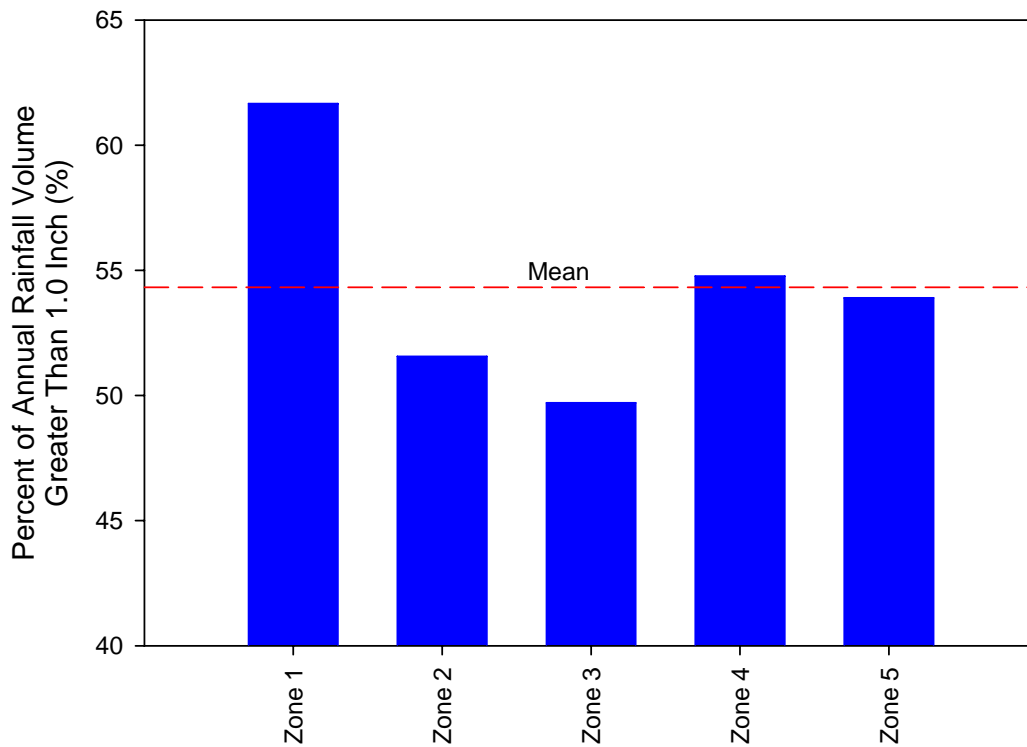

Figure 4-11. Percentage of Annual Rainfall Depth Lost to Initial Abstraction on Impervious Surfaces.

SECTION 5

PERFORMANCE EFFICIENCY OF STORMWATER MANAGEMENT SYSTEMS

A substantial amount of research has been conducted over the past 20-25 years which demonstrates that some commonly used stormwater management techniques are much more efficient in removing and retaining pollutant loadings than others. However, in spite of this research, many stormwater management facilities are selected or designed based upon the ability of the system to function hydraulically rather than with regards to pollutant removal effectiveness. One of the primary objectives of this project is to evaluate stormwater management systems from a pollutant removal perspective and to make recommendations concerning the types of stormwater management facilities which should be emphasized to maximize pollutant removal effectiveness while maintaining proper hydraulic function of the system.

This section provides an overview of the anticipated pollutant removal effectiveness of common stormwater management systems used within the State of Florida. First, a literature review of previous research performed on typical stormwater management systems within Florida is presented along with a summary of the pollutant removal effectiveness achieved by the evaluated studies. Next, estimates of the pollutant removal effectiveness of common stormwater management systems are provided based upon current stormwater management design criteria within the State. These estimates are based upon a combination of computer modeling and linear regression evaluations of relationships between performance efficiency and significant design parameters based on previous research.

The terms "detention" and "retention" are often used interchangeably by engineers, even those who have been designing stormwater management facilities for many years. For purposes of this evaluation, the following definitions shall apply:

Detention: The collection and temporary storage of stormwater, generally for a period of time ranging from 24-72 hours, in such a manner as to provide for treatment through physical, biological or chemical processes with subsequent gradual release of stormwater to downstream receiving waters.

Retention: On-site storage of stormwater with subsequent disposal by infiltration into the ground or evaporation in such a manner as to prevent direct discharge of stormwater runoff into receiving waters.

5.1 Literature-Based Removal Efficiencies for Typical Stormwater Treatment Systems

A literature review was conducted of previous research performed in the State of Florida which quantifies pollutant removal efficiencies associated with various stormwater management systems used throughout the State. Each study which was obtained was evaluated for adequacy of the database, with special attention to factors such as length of study, number of runoff events monitored, monitoring methodology, as well as completeness and accuracy of the work. It was preferred that selected studies contain at least a 3-month period of data collection, representing a wide range of rainfall and antecedent dry period conditions.

Unfortunately, for a number of studies, the only available database for a particular stormwater management facility represented a relatively small and limited data collection process. In other cases, the study evaluated only the outflow from the system and did not present sufficient information to estimate system performance efficiency. Some studies were identified which evaluated hybrid or experimental systems which cannot be classified into a common stormwater system type associated with an existing design criteria. All evaluated studies were carefully examined on a case-by-case basis and a decision was made on whether or not to include the data in the removal efficiency estimates. In general, studies with less than five monitored storm events and studies which could not be classified into a common stormwater management practice were excluded. Only stormwater management facilities constructed within the State of Florida were included in this evaluation. The resulting database contains pollutant removal efficiencies for the following types of common stormwater management facilities:

1. Dry retention
2. Wet detention
3. Dry detention with filtration
4. Off-line retention/detention (dual pond)

A discussion of removal efficiencies for typical stormwater treatment systems is provided in the following sections.

5.1.1 Dry Retention Systems

Dry retention systems consist primarily of infiltration basins which are used to retain stormwater runoff on-site, thus reducing discharge to downstream waterbodies. Disposal of stormwater runoff occurs by infiltration into the groundwater and, to a lesser degree, evaporation from the water surface during periods of standing water. Because these systems rely primarily on infiltration of stormwater into the ground to regain the available pond storage, construction of these systems is limited to areas with low groundwater tables and permeable soils. The soil and water table conditions must be such that the system can provide for a new volume of storage through percolation or evaporation within a specified period, generally 72 hours following the stormwater event.

A schematic diagram of a typical dry retention system is given in Figure 5-1. This system is constructed as a dry basin with the pond bottom a minimum of 1-3 ft above the seasonal high groundwater table elevation, depending on applicable design criteria. The pond is typically designed to hold a volume of stormwater, called the "treatment volume", which is equivalent to either the runoff generated by a specified rain event or a certain depth of runoff over the contributing watershed area.

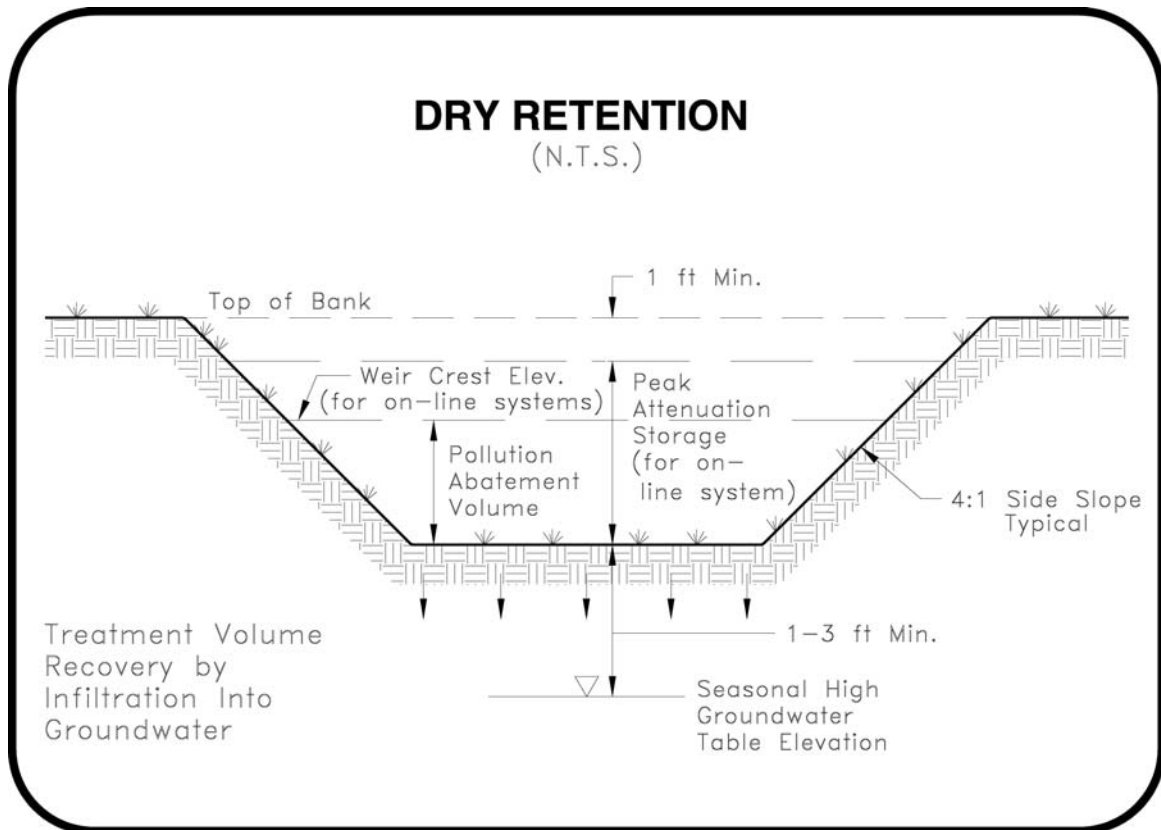

Figure 5-1. Schematic of a Dry Retention Facility.

Dry retention ponds may be constructed as either on-line or off-line systems. Off-line systems typically provide storage for the treatment volume only. These systems typically utilize a weir structure to divert runoff into the retention pond until the treatment volume is reached. Runoff discharges in excess of the volume bypass the pond and discharge into the detention portion of the system or directly off-site. In an on-line system, the entire runoff volume discharges into the pond. Runoff in excess of the treatment volume may discharge through an outfall structure. For on-line systems, an additional volume may be provided above the treatment volume for peak attenuation of on-site discharges during major (10-year, 25-year, or 100-year) storm events. The bottom of the pond is designed to be dry at all times except within 72 hours of the design storm event.

Although retention ponds are most commonly constructed as basins similar to Figure 5-1, retention pond designs can be highly variable as long as the system performs the desired infiltration function. Retention ponds can be constructed as linear pond areas along road right-of-way, within recreational sites such as playgrounds or athletic fields, within natural depressional areas, in open land, as part of the landscaping for a commercial site, or as a shallow swale. Dual use of facilities provides a method for conserving valuable land resources while incorporating stormwater management systems into the on-site landscaping.

As the stormwater runoff percolates through the soil, migrating toward the underlying groundwater, a variety of physical, chemical, and biological processes occur which retain a majority of the stormwater pollutants in the upper layers of the soil within the retention basin (Harper, 1985; Harper, 1988). Previous research conducted by Harper (1985, 1988) has indicated that stormwater pollutants are trapped in relatively stable associations in the upper 4-6 inches of soil within retention basins. Concentrations of nutrients and heavy metals in groundwater beneath dry retention basins are typically lower in value than measured in stormwater runoff entering the retention system.

Even though dry retention systems prevent direct discharge of stormwater runoff to receiving waterbodies, care must be taken in the design of retention facilities to ensure that significant underground migration of pollutants does not occur to adjacent surface waters. Pollutant loadings removed by the system may still reach adjacent receiving waters when retention basins are constructed immediately adjacent to the shoreline. Lateral distances between retention ponds and surface water should be maintained as large as possible, at least 100 ft or more, depending on the site conditions (FDEP, 1988).

The side slopes and bottoms of dry retention basins should be fully vegetated with sod cover grown in sandy permeable soils. Vegetation plays a crucial role in the removal of contaminants from stormwater and in stabilization of the soil. The roots from vegetation assist in maintaining the permeability of the basin soils. Bahia grass is typically used for sod cover since it is drought resistant and can withstand periods of inundation.

In spite of the fact that on-line dry retention systems are used extensively throughout the State of Florida, relatively little research has been conducted to evaluate the pollutant removal effectiveness of these systems. Only two references on dry retention systems were identified during the literature search, both of which were conducted as part of the Orlando Areawide 208 Assessment during the late 1970s. A summary of the treatment efficiencies for dry retention systems, based on available research studies in Florida, is given in Table 5-1. The first study, published in 1978 by the East Central Florida Regional Planning Council (ECFRPC) was conducted on a commercial watershed in Orlando. Removal efficiencies for the dry retention system reported in this study ranged from approximately 61% for total phosphorus to more than 90% for species of nitrogen. Information on the amount of retention storage available within this system was not provided so the removal efficiencies could not be related to a particular treatment volume.

The second study, conducted by Wanielista (1978), was also part of the Orlando Areawide 208 Assessment. This study presented estimated removal efficiencies for dry retention systems based upon simulations of yearly rainfall/runoff events. Removal efficiencies are presented as a function of retention volume, with increasing removal efficiencies associated with increasing runoff volumes retained. This simulation assumes that the retention pond drains completely between rain events so that the design retention volume is available for the next storm event. Removal efficiencies of approximately 80% are associated with retention of 0.25 inches of runoff, 90% for 0.5 inches of runoff, and 95% for a retention volume of 0.75 inches of runoff. These values have been used extensively throughout the State of Florida as estimates of the performance efficiency of dry retention systems.

TABLE 5-1
TREATMENT EFFICIENCIES FOR DRY
RETENTION SYSTEMS BASED ON SELECTED
RESEARCH STUDIES IN FLORIDA

REFERENCE	STUDY SITE/ LAND USE	TYPE OF EFFICIENCIES REPORTED	MEAN REMOVAL EFFICIENCIES (%)							
			Total N	Ortho -P	Total P	TSS	BOD	Total Cu	Total Pb	Total Zn
ECFRPC (1978)	Orlando/ Commercial	Surface Water	91	--	61	85	92	--	--	--
Wanielista (1978)	Orlando/ Urban	Calculated								
		a. 0.25" ret.	80	80	80	80	80	80	80	80
		b. 0.50" ret.	90	90	90	90	90	90	90	90
		c. 0.75" ret.	95	95	95	95	95	95	95	95
		d. 1.00" ret.	99	99	99	99	99	99	99	99
		e. 1.25" ret.	99.9	99.9	99.9	99.9	99.9	99.9	99.9	99.9

It is obvious that removal efficiencies achieved in retention systems are regulated primarily by the amount of runoff volume retained. In general, the annual pollutant removal effectiveness of a retention system should increase as the retention volume increases. Since dry retention systems do not always recover the entire pollution abatement volume before the next storm event, the actual observed pollutant removal efficiencies for dry retention systems are less than the theoretical values presented by Wanielista. The removal efficiencies proposed by Wanielista incorporate a first-flush effect which assumes that a large portion of the pollutant loading occurs in the initial portion of the runoff volume, increasing the theoretical removal efficiencies achieved by retention of a specified runoff depth. However, in many watersheds, significant first-flush effects do not occur, and therefore, removal efficiencies will not be as high as reported in the Wanielista study. Subsequent research has suggested that first-flush effects occur primarily on relatively small watersheds (< 10 acres) with a high percentage of DCIA. In large watersheds with a low or moderate DCIA percentage, significant first-flush effects may not occur.

As development intensity increases, so does the volume of runoff from a given storm event. For example, a 1-inch storm event on a rural residential development may produce 0.2 inches of runoff while the same storm event at a commercial site may produce 0.6 inches of runoff. To achieve similar pollutant removal efficiencies, a larger retention treatment volume would be required for the commercial site than the rural residential site. Therefore, the treatment volume alone cannot be directly correlated to the pollutant removal efficiency of the stormwater treatment system. Instead, the achievable pollutant removal efficiencies are directly related to the development intensity and the specified treatment volume. This concept will be discussed in detail in Section 5.2. With dry retention treatment systems, the mass pollutant removal efficiencies are directly related to the volume of runoff retained as a percent of the total runoff volume produced.

5.1.2 Wet Detention Systems

Wet detention systems are currently a very popular stormwater management technique throughout the State of Florida, particularly in areas with high groundwater tables. A wet detention pond is simply a modified detention facility which is designed to include a permanent pool of water. These permanently wet ponds are designed to slowly release collected runoff through an outlet structure. A schematic diagram of a wet detention system is given in Figure 5-2.

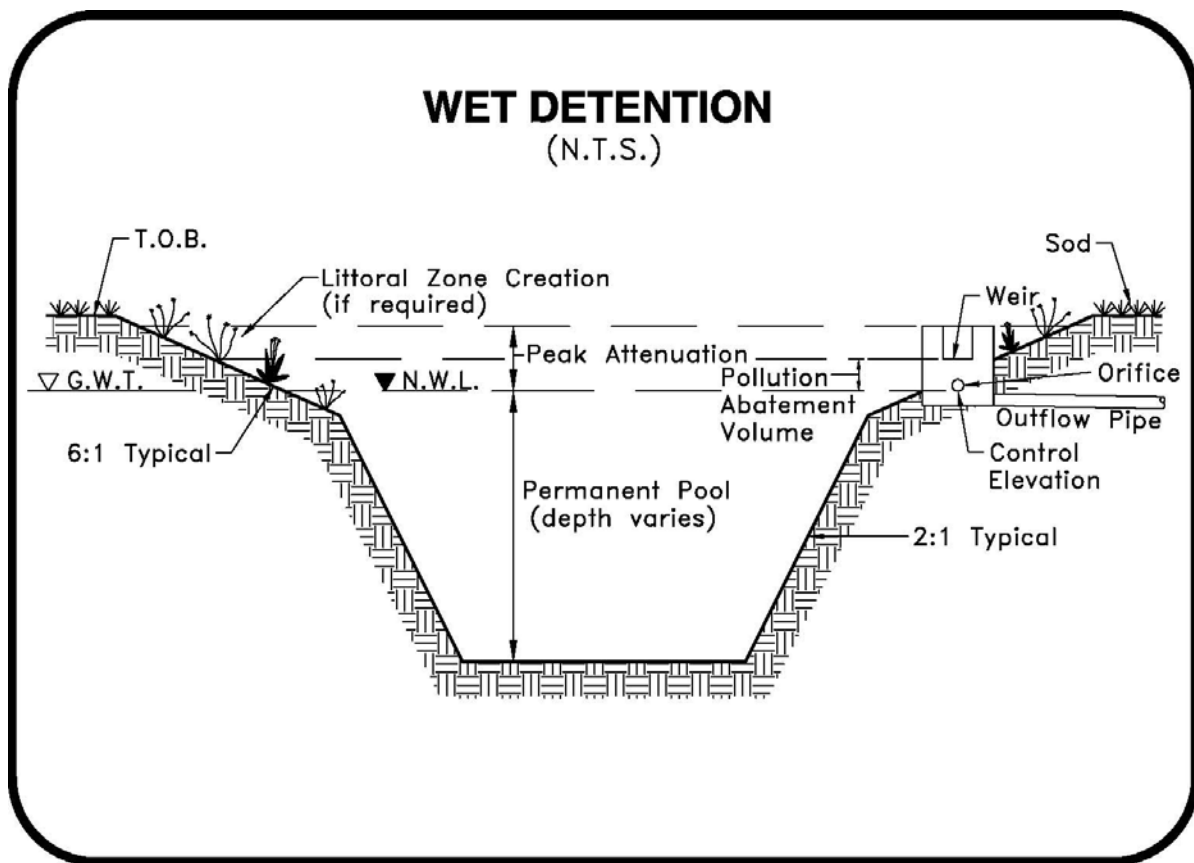

Figure 5-2. Schematic of a Wet Detention System.

Pollutant removal processes in wet detention systems occur through a variety of mechanisms, including physical processes such as sedimentation, chemical processes such as precipitation and adsorption, and biological uptake from algae, bacteria, and rooted vegetation. In essence, these systems operate similar to a natural lake system.

The water level in a wet detention system is controlled by an orifice located in the outfall structure from the pond. A treatment volume above the orifice invert elevation is calculated for each facility based upon a specified depth of runoff over the contributing drainage basin area. Inputs of stormwater runoff equal to or less than the treatment volume leave the facility through an orifice in the outfall structure, percolation into the surrounding groundwater table, or by evaporation. Stormwater inputs into the facility in excess of the treatment volume can exit from the facility directly over a weir included in the pond outfall structure. The weir is designed to provide attenuation for peak storm events so that the post-development rate of discharge from the facility does not exceed the pre-development rate of discharge for a specified design storm, typically a 25-year storm event. A littoral zone may be planted around the perimeter of a wet detention facility to provide additional biological uptake and enhanced biological communities.

Upon entering a wet detention facility, stormwater inputs mix with existing water contained in the permanent pool. Physical, chemical, and biological processes begin to rapidly remove pollutant inputs from the water column. Water which leaves through the orifice in the outfall structure is a combination of the mixture of stormwater and the water contained within the permanent pool. In general, the concentration of constituents in the permanent pool are typically much less than input concentrations in stormwater runoff, resulting in discharges from the facility which are substantially lower in concentration than found in raw stormwater. As a result, good removal efficiencies are achieved within a wet detention facility for most stormwater constituents. Although the littoral zone provides a small amount of enhanced biological uptake, previous research has indicated that a vast majority of removal processes occurring in wet detention facilities occur within the permanent pool volume rather than in the littoral zone vegetation for the treatment volume (Harper, 1985; Harper 1988; Harper and Herr, 1993).

Wet detention systems offer several advantages over some other stormwater management systems. First, wet detention systems provide relatively good removal of stormwater constituents since physical, chemical, and biological mechanisms are all available for pollutant attenuation. Other stormwater management facilities provide only one or two of these basic removal methods for stormwater. A second advantage of wet detention systems is that the systems are not complex and can be relatively easily maintained. Wet detention systems do not have underdrain systems which can become clogged and need periodic maintenance. Wet detention systems can be viewed as amenities in development projects.

Of the stormwater facilities investigated during this evaluation, probably the most amount of research within the State of Florida has been conducted on wet detention systems. Unfortunately, much of the existing research was conducted on wet detention systems which were not constructed to current design standards regarding mean detention time, pond configuration, and depth. The majority of the available studies do not present information regarding the treatment volume or residence time within the wet detention system. However, based on the relative pond area and volume for the various studies, it appears that the typical residence time provided in the evaluated ponds is approximately 15 days or less.

A summary of treatment efficiencies for wet detention systems based on selected research studies in Florida is given in Table 5-2. Measured removal efficiencies for orthophosphorus, total phosphorus, TSS, and heavy metals are relatively consistent between the studies presented within the table. In contrast, a high degree of variability in measured removal efficiencies is present for total nitrogen. Removal efficiencies for total nitrogen range from 12-63% for the studies presented in Table 5-2. Wet detention systems provide mean removal efficiencies of approximately 60-65% for total phosphorus, BOD, and copper, while removal efficiencies for orthophosphorus, TSS, lead, and zinc approach or exceed 75-85%.

TABLE 5-2
TREATMENT EFFICIENCIES FOR WET
DETENTION SYSTEMS BASED ON SELECTED
RESEARCH STUDIES IN FLORIDA

REFERENCE	STUDY SITE/ LAND USE	TYPE OF EFFICIENCIES REPORTED	MEAN REMOVAL EFFICIENCIES (%)							
			Total N	Ortho-P	Total P	TSS	BOD	Total Cu	Total Pb	Total Zn
PBS&J (1982)	Brevard County/ Commercial	Surface Water	--	--	69	94	--	--	96	--
Cullum (1984)	Boca Raton/ Residential	Surface Water Overall	12 15	93 82	55 60	68 64	-- --	-- --	-- --	-- --
Yousef, et al. (1986)	Maitland/ Highway	Surface Water	35	94	81	--	--	56	88	92
Yousef, et al. (1986)	EPCOT/ Highway	Surface Water	44	92	62	--	--	--	--	88
Martin & Miller (1987)	Orlando/ Urban	Surface Water	--	57	38	66	--	--	40	--
Harper (1988)	Orlando/ Residential	Surface Water	--	--	91	82	90	90	90	96
Harper & Herr (1993)	DeBary/ Commercial & Residential	Overall								
		a. $t_d=7$ days b. $t_d=14$ days	20 30	40 60	60 70	85 85	50 60	40 50	60 85	85 95
Rushton & Dye (1993)	Tampa/Light Commercial	Surface Water	--	67	65	55	--	--	--	51
Rushton, et al. (1995)	Tampa/ Commercial	Overall								
		a. $t_d=2$ days b. $t_d=5$ days c. $t_d=14$ days	33 16 63	69 39 92	62 57 90	71 67 94	-- -- --	ND 1 55	ND ND 92	56 32 87
		a. $t_d=1$ day b. $t_d=7$ days c. $t_d=14$ days	4 33 36	56 73 88	20 56 65	-- -- --	-- -- --	32 81 92	41 88 96	-- -- --
DB Environmental (2005)	Melbourne									
MEAN VALUES¹			37	79	69	77	75	69	84	85

1. Based on 14-day residence time, if applicable

In many of the studies, the ability of the system to remove total nitrogen was heavily dependent upon the proportion of total nitrogen present as organic nitrogen. Organic nitrogen is not readily available, either biologically or chemically, and there are relatively few mechanisms for removal of this species in a wet detention system. In contrast, both NO_x and NH_3 are readily taken up in biological processes which accounts for the relatively good removal efficiencies achieved for these species in wet detention ponds. In systems where organic nitrogen represents the dominant portion of the total nitrogen in the incoming stormwater flow, removal of total nitrogen can be expected to be relatively poor. If inorganic species of NO_x and NH_3 represent the dominant nitrogen species found, then removal efficiencies for total nitrogen can be expected to increase. On an average basis, wet detention systems with a detention time of 14 days can be expected to provide a net removal of approximately 20-40% for total nitrogen; 60-70% for total phosphorus and copper; and 75-85% or more for TSS, total lead and total zinc.

The report by Harper and Herr (1993) presents separate removal efficiencies for pond residence times of approximately 7 days, along with detention times of 14 days or more. With the exception of TSS, increasing the pond detention time results in a slight improvement in removal efficiencies for the listed parameters. At a detention time of 7 days, removal of total nitrogen, total phosphorus and TSS is estimated to be approximately 20%, 50%, and 85%, respectively. At a detention time of 14 days, removal of total nitrogen, total phosphorus and TSS increase slightly to approximately 30%, 70%, and 85%, respectively. Little additional improvement in removal efficiencies was observed for most parameters at detention times in excess of 14 days up to the maximum detention time of 41 days included in the study.

The report by Ruston, et al. (1995) summarizes pollutant removal efficiencies achieved within a wet detention pond in Tampa which receives stormwater runoff from a light commercial area. Pollutant removal efficiencies are provided for pond detention times of 2, 5, and 14 days. In general, pollutant removal efficiencies obtained at a detention time of 2 days are lower than removal efficiencies obtained at a detention time of 14 days for all evaluated parameters. However, the lowest removal efficiencies in the study were obtained at the 5-day detention time. Rushton, et al. reports that the lower efficiencies observed during the 5-day detention time study period were highly influenced by one extreme storm event where almost 6 inches of rain occurred during a single week.

The most recent study to evaluate impacts of residence time on performance efficiency was conducted by DB Environmental (2005). This study was performed on a wet detention pond in Melbourne where portions of the pond were isolated to create microcosms to simulate residence times of 1, 7, and 14 days. In general, removal efficiencies for all of the evaluated parameters increased with increases in detention time within the microcosms. The removal efficiencies achieved at the 14-day residence time are similar to values reported by Harper and Herr (1993), also for a 14-day residence time.

5.1.3 Dry Detention (With and Without Filtration/Underdrains)

Historically, dry detention facilities have been one of the most common stormwater management techniques used throughout the State of Florida, particularly in South Florida. These systems are typically utilized in high groundwater table areas where the normal groundwater level makes the use of a retention type facility less feasible. Dry detention systems are intended to be dry basins which are designed to hold a specific quantity of stormwater runoff (treatment volume). Recovery of the design treatment volume occurs as a result of migration of the stormwater runoff through the pond bottom, discharge through an outfall orifice structure, or into an underdrain system or side bank filter constructed around the perimeter or bottom of the pond.

A schematic diagram of a dry detention system (with underdrain) is provided in Figure 5-3. The underdrain system is typically used to control the existing groundwater table elevation in the vicinity of the pond and to improve the recovery rate of the pollution abatement volume. Dry detention ponds are also constructed with side bank filters which perform a similar function.

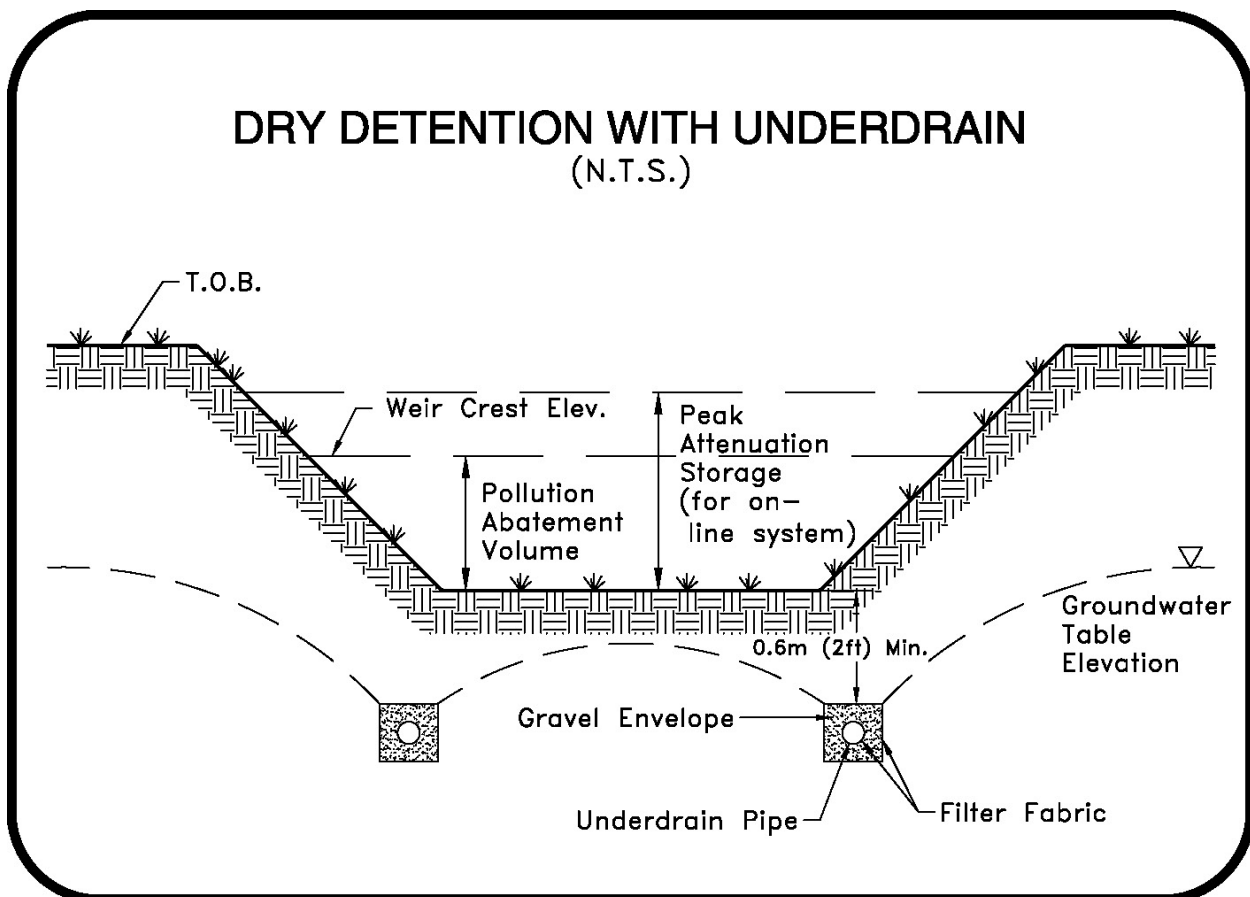

Figure 5-3. Schematic of a Dry Detention with Underdrain System.

Dry detention systems (without filtration) have been used commonly within the South Florida Water Management District (SFWMD) and the Southwest Florida Water Management District (SWFWMD). In the St. Johns River Water Management District (SJRWMD), dry detention is limited to projects less than 5 acres in size or where the ground water table or soil conditions limit the feasibility of other BMPs. Dry detention systems utilize an orifice or V-notch to slowly discharge the specified treatment volume following a storm event.

Physical processes such as sedimentation, and chemical processes such as precipitation and adsorption, are the primary mechanisms responsible for pollutant removal in dry detention with underdrain systems. Stormwater inputs into these systems are typically evacuated within 24-72 hours, and as a result, biological processes such as uptake of nutrients by plant surfaces and roots, are severely limited and do not play a significant role in the removal of stormwater pollutants. Removal of particulate pollutants by sedimentation within the pond, as well as entrapment of particles within the filter system or soils during migration toward the underdrain system, are the primary physical removal processes in dry detention with filtration systems. Removal of particulate forms of phosphorus and heavy metals may also occur due to sedimentation through the pond. These systems have an extremely limited ability to remove dissolved constituents, most of which are best removed through biological processes.

Many dry detention systems which utilize underdrains are constructed in a manner which requires the stormwater to migrate through on-site soil prior to entering the underdrain system. This design technique probably enhances the removal efficiencies achieved by these systems due to the natural adsorption capacity of soils. Other designs pass the runoff through sand filter media prior to discharge. However, the ability of common silica sand filter systems to remove dissolved constituents is severely limited (Harper and Herr, 1993).

As seen in Figure 5-3, the underdrain and filter systems associated with dry detention facilities are sometimes constructed to intercept and control the existing groundwater elevations in the vicinity of the basin to maintain a dry pond bottom. This causes an influx of on-site groundwater into the underdrain system, resulting in a continuous flow from the system which is unrelated to rain events. This continuous flow of groundwater may actually create a system where substantially more mass leaves the stormwater facility on an annual basis than enters the system through stormwater runoff.

However, it is possible for dry detention systems to provide good removal efficiencies for total nitrogen, total phosphorus, TSS, and BOD. This can be accomplished by ensuring that the seasonal high groundwater table is one or more feet below the proposed pond bottom and underdrain elevation. The separation between pond bottom and seasonal high groundwater table elevation allows the pond to function as a dry retention pond system for some rain events. One-hundred percent removal is achieved for all runoff infiltrated through the pond bottom which is not intercepted by the underdrain system. Pollutant removal efficiencies for dry detention systems can also be improved by removing the underdrain filter system, and replacing the filter system with a drawdown V-notch or orifice similar to a wet detention system.

As previously discussed, the pollutant removal effectiveness of dry detention systems are largely affected by the elevation of the underdrain system and pond bottom in relation to the seasonal high groundwater table. This is evident in the literature-based treatment efficiencies for the dry detention systems, provided in Table 5-3, based on selected research studies performed in Florida. Each of these systems is constructed with a side bank filter system for drawdown of the treatment volume. The first entry in Table 5-3 contains removal efficiencies from research conducted at the Publix shopping center dry detention pond in Bradfordville, north of Tallahassee. Overall mass removal efficiencies greater than 80% were achieved for total nitrogen, total phosphorus, TSS, and BOD. These high mass removal efficiencies were observed since 66% of the runoff entering the pond infiltrated through the pond bottom. Only 34% of the runoff which entered the pond discharged through the underdrain system or the overflow structure. This pond functioned much differently than typical dry detention with filtration systems in other areas of Florida.

TABLE 5-3

**TREATMENT EFFICIENCIES FOR DRY
DETENTION WITH FILTRATION SYSTEMS BASED
ON SELECTED RESEARCH STUDIES IN FLORIDA**

REFERENCE	STUDY SITE/ LAND USE	FILTER SYSTEM TYPE	MEAN REMOVAL EFFICIENCIES (%)							
			Total N	Ortho-P	Total P	TSS	BOD	Total Cu	Total Pb	Total Zn
Bradfordville Study ¹	Leon County/ Commercial	Side Bank	80	--	92	98	93	--	--	--
Harper & Herr ² (1995)	Orange County/ Commercial & Residential	Side Bank	-136	-229	-86	77	-49	68	93	25
MEAN VALUES			-28	--	3	88	22	--	--	--

1. 66% of runoff infiltrated through pond bottom
2. Underdrain installed below surface groundwater elevation

Conversely, the second entry in Table 5-3 summarizes a study conducted on a dry detention pond in Orange County, FL. The underdrain for this pond was constructed several feet below the average groundwater table elevation surrounding the pond. For this reason, groundwater continually flowed from the surrounding area into the underdrain system and directly into the adjacent receiving waterbody. The excess groundwater discharge resulted in a net export of total nitrogen, orthophosphorus, total phosphorus, and BOD for this treatment facility.

Based on the research performed on dry detention with filtration and dry detention systems, it is apparent that a majority of the mass removal efficiencies are due to infiltration through the pond bottom and not due to removal processes occurring within the treatment facilities. Ponds with bottoms constructed above the seasonal high groundwater table elevation will exhibit higher mass pollutant removal efficiencies than ponds constructed into the seasonal high groundwater table.

Maximum removal efficiencies for a dry detention system could be achieved using a design which incorporates infiltration through the pond bottom and forces the remaining inputs into the underdrain system to pass through the filter media, while maintaining an underdrain elevation at least 1 ft above the seasonal high groundwater table. This system would utilize infiltration and filtration as the primary removal mechanisms.

It appears that annual mass removal efficiencies for dry detention with filtration systems are highly variable. However, in order to provide comparative pollutant removal efficiencies for common stormwater management systems, theoretical pollutant removal efficiencies are assumed for dry detention with filtration systems based upon the assumption that 25% of the annual runoff volume which enters the pond infiltrates through the pond bottom. The estimated mass removal efficiencies for a dry detention with filtration system, based upon this assumption, is estimated to be approximately 30% for total nitrogen, 40% for total phosphorus, 90% for TSS, and 50% for BOD. These removal efficiencies may improve slightly if the treatment volume is increased beyond the standard design. Since the primary removal mechanism is the physical process of sedimentation of particles, the increased detention time provided by the additional treatment volume has the potential to increase system efficiency. However, most of the settleable solids should be removed very quickly and little additional removal may occur at the extended detention time.

5.1.4 Off-line Retention/Detention (Dual Pond) Systems

Off-line retention/detention systems provide an off-line retention pond for the treatment volume and an on-line detention pond for flood control and attenuation of peak discharges. A diversion device, often called a "smart box", is used to divert first-flush stormwater runoff into the retention pond. When the retention pond fills, the remaining stormwater runoff is diverted directly to a detention pond for flow attenuation purposes.

A schematic diagram of an off-line retention/detention system is given in Figure 5-4. Volume recovery in the retention portion of the system occurs primarily through groundwater infiltration and evaporation. Drawdown in the detention pond occurs through an outlet structure designed to match pre- and post-development discharge rates. Off-line retention/detention systems have been used sporadically throughout Florida, although these systems are required within the City of Orlando. Even though this type of system requires two ponds rather than one, the required ponds are typically much smaller in size than a single pond, and can be placed into a development landscape more easily than a single large system, minimizing potential impacts on space requirements.

Off-line retention/detention systems provide pollutant removal mechanisms in both the retention system as well as the detention portion of the pond. Stormwater runoff retained in the retention system infiltrates through the ground with 100% removal efficiency. Removal processes such as settling, adsorption, and precipitation reactions occur in the detention facility during the drawdown period and also provide similar mass removal efficiencies to the dry detention system.

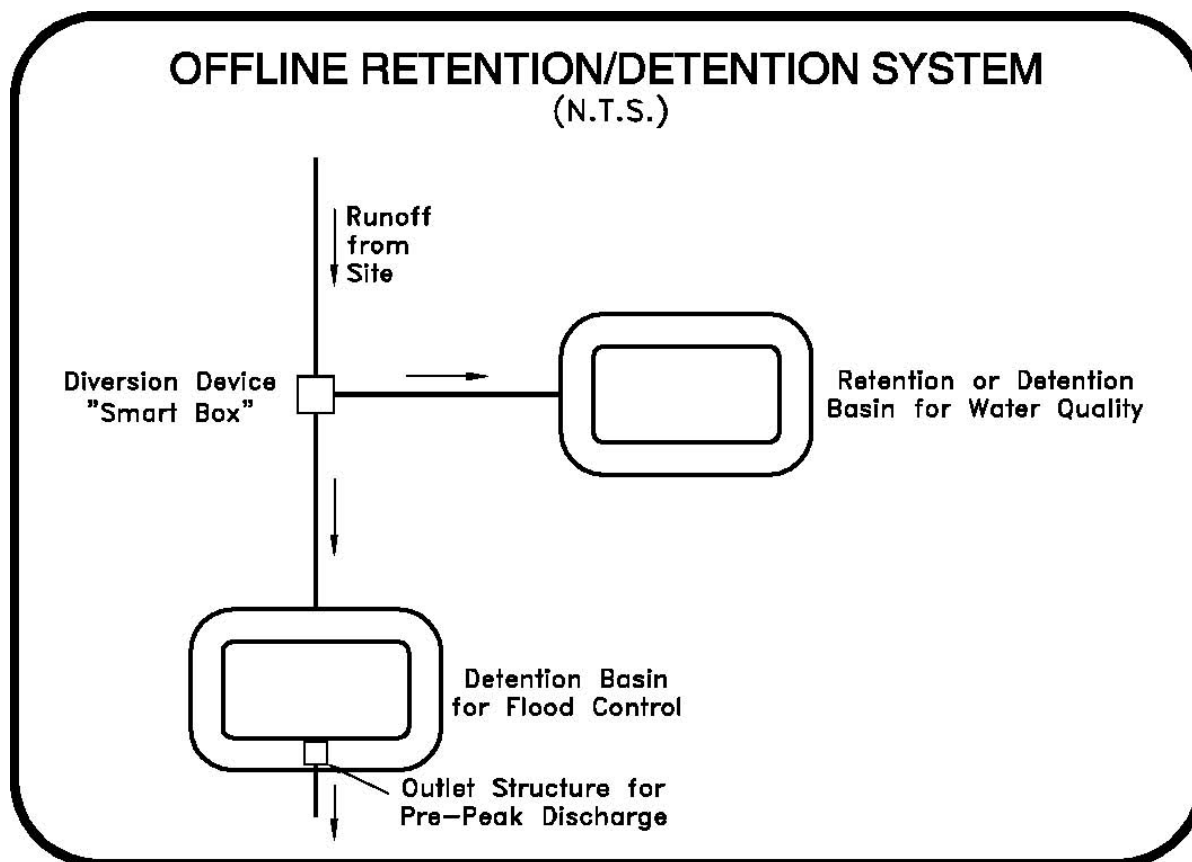

Figure 5-4. Schematic of an Off-Line Retention/Detention System.

A summary of treatment efficiencies for off-line retention/detention systems based on studies conducted within the State of Florida is given in Table 5-4. Only two studies have been conducted in the State of Florida which provide pollutant removal efficiencies for off-line retention/detention systems. Each of these studies was conducted by Harper (1988) in the Orlando area on residential and commercial watersheds, constructed within the City of Orlando, which provided a treatment volume of 0.5 inches over the contributing watershed area.

Excellent removal efficiencies were achieved in the study reported by Harper (1988) in the Orlando residential watershed. Measured removal efficiencies for total nitrogen, total phosphorus, TSS, BOD, total copper, and total zinc were equal to 85% or more. Removal efficiencies measured in the commercial watershed studies are somewhat lower than those reported in the residential watershed. Removal efficiencies for total nitrogen, total phosphorus, TSS, and BOD measured in this study were 30%, 76%, 89%, and 64%, respectively.

Mean values for the two studies are reported at the bottom of Table 5-4. On an average basis, off-line retention/detention facilities provide excellent removal efficiencies for total nitrogen, total phosphorus, TSS, BOD, and heavy metals. Annual removal efficiencies for this type of system can be expected to be approximately 60-65% for total nitrogen and total copper; 75-85% for total phosphorus and total lead; and 80-90% for TSS, BOD, and total zinc.

TABLE 5-4

**TREATMENT EFFICIENCIES FOR OFF-LINE
RETENTION/DETENTION SYSTEMS (DUAL POND) BASED
ON SELECTED RESEARCH STUDIES IN FLORIDA**

REFERENCE	STUDY SITE/ LAND USE	TYPE OF EFFICIENCIES REPORTED	MEAN REMOVAL EFFICIENCIES (%)							
			Total N	Ortho -P	Total P	TSS	BOD	Total Cu	Total Pb	Total Zn
Harper (1988)	Orlando/ Residential	Overall	85	96	92	95	90	85	71	91
Harper (1988)	Orlando/ Commercial	Surface Water	30	61	76	89	64	47	80	81
MEAN VALUES			58	79	84	92	77	66	76	86

5.1.5 Comparison of Treatment Efficiencies for Typical Stormwater Management Systems

A comparison of treatment efficiencies for typical stormwater management systems used in the State of Florida is given in Table 5-5 based upon information provided in the literature review. Comparative removal efficiencies are provided for dry retention, wet detention, and dry detention. For the purposes of the evaluation, retention is considered any method of infiltrating water into the ground. This includes traditional retention ponds, stormwater reuse, swales, or the use of exfiltration trenches.

TABLE 5-5

**ESTIMATED POLLUTANT REMOVAL EFFICIENCIES
FOR COMMON STORMWATER TREATMENT FACILITIES**

TYPE OF SYSTEM	ESTIMATED REMOVAL EFFICIENCIES (%)			
	Total N	Total P	TSS	BOD
Retention, Reuse, Source Reduction, Swales	100% for Retained Volume			
Wet Detention				
a. 7-day detention time	20	60	85	50
b. 14-day detention time	30	70	85	60
Dry Detention	0-30	0-40	90	0-50

Of the three basic stormwater treatment systems, retention provides the highest level of treatment possible. All stormwater runoff retained or infiltrated into the ground is assumed to have a 100% mass pollutant removal efficiency for the retained volume. This is the best possible stormwater treatment system to use in terms of pollutant removal efficiency. Mass removal efficiencies for wet detention have been divided into 7-day and 14-day detention times, with mass removal efficiencies ranging from 20-30% for total nitrogen, 60-70% for total phosphorus, 85% for TSS, and 50-60% for BOD. Estimated mass removal efficiencies for dry detention systems are 0-30% for total nitrogen, 0-40% for total phosphorus, 90% for TSS, and 0-50% for BOD, depending on the relationship between the pond bottom or underdrain and the groundwater table elevation. These removal efficiencies are based upon anticipated settling of TSS within the pond and the range of listed pollutants present in a particulate form. Based on the information provided in Table 5-5, the most effective stormwater management system in terms of retaining stormwater pollutants is dry retention, followed by wet detention, and dry detention systems.

5.2 Performance Efficiency of Existing Stormwater Design Criteria

The literature review presented in the previous section provides estimates of the performance efficiency of stormwater management systems which have been evaluated within the State of Florida. However, each of these studies reflects relatively site-specific performance efficiency data based upon the specific design of the stormwater management facility and the regional meteorological characteristics in the vicinity of the study site. Since meteorological characteristics and design criteria for stormwater management systems vary widely throughout the State of Florida, performance efficiency data for a stormwater management system constructed in one part of the state may not be applicable to similar stormwater management systems constructed in other parts of the State.

Evaluations were conducted as part of this evaluation to provide estimates of the anticipated performance efficiencies of stormwater management systems within the State of Florida considering variations in design criteria and meteorological characteristics throughout the State. These analyses are then used to compare the anticipated performance efficiency of stormwater management systems constructed according to current design criteria with the overall performance efficiency objectives outlined in the Water Resource Implementation Rule (Chapter 62-40 FAC).

5.2.1 Dry Retention

As discussed in Section 2, design criteria for dry retention systems within the State of Florida are based upon providing treatment for a volume equivalent to a certain depth of runoff, typically 0.5 inch, over the project area, or the runoff generated from a specified rain event, typically 1 inch. Estimates of the annual mass removal efficiencies associated with these design criteria are discussed in the following sections.

5.2.1.1 Evaluation Methodology

The anticipated annual mass removal efficiencies achieved by dry retention systems were evaluated for each of the five meteorological zones over a wide range of DCIA percentages and non-DCIA curve numbers. These evaluations were conducted using a continuous simulation of runoff volumes generated on a hypothetical 1 acre site using the historical rainfall data sets for meteorological sites in each of the five zones. This analysis was performed for DCIA percentages ranging from 0-100 in 5-unit intervals and for non-DCIA curve numbers ranging from 30-95 in 5-unit intervals, along with a non-DCIA curve number of 98, comprising 315 combinations of DCIA percentages and non-DCIA curve numbers.

The runoff generated by individual rain events was calculated using the continuous simulation methodology outlined in Section 4.2.1. This methodology was used to estimate the runoff volume generated by individual rain events within the historical rainfall records. The runoff generated by the rain event was instantaneously routed into a theoretical dry retention pond with a treatment volume equivalent to a specified depth of runoff or the runoff from a specified rain event. A hypothetical drawdown curve was established for the retention pond based upon typical drawdown design criteria which require recovery of 50% of the treatment volume in 24 hours and 100% of the treatment volume in 72 hours. If the runoff volume exceeded the capacity of the retention pond, the remaining volume was assumed to bypass the pond directly with a treatment efficiency of 0. Each storm within the historical record was routed through the theoretical retention pond with excess runoff assumed to bypass the system.

The evaluation methodology used to estimate the performance efficiency of dry retention systems is based upon the following assumption:

Watershed areas contributing to each stormwater management facility do not exhibit first-flush effects with respect to runoff concentrations. Although small, highly impervious watershed areas, typically less than 5-10 acres in size, may exhibit first-flush effects under certain conditions, there is no scientific evidence to indicate that larger sub-basin areas exhibit a first-flush effect on a continuous basis. Therefore, the analyses presented in this report may be somewhat conservative for small basins which exhibit a first-flush effect.

For this analysis, it is assumed that the calculated performance efficiency of a dry retention stormwater management system is based entirely upon the percentage of water retained during each storm event. For a dry retention system, it is assumed that a pollutant removal efficiency of 100% is achieved for the entire treatment volume retained within the system. As a result, removal efficiencies of 100% are achieved for all rainfall events which generate runoff volumes less than or equal to the available treatment volume within the pond. Rainfall events which generate runoff in excess of the available volume are assumed to have a removal efficiency of 100% for all generated runoff up to the available treatment volume, with a removal efficiency of 0% for runoff inputs in excess of the treatment volume.

Pollutant removal efficiencies were calculated for selected dry retention treatment volumes for each meteorological zone and each of the 315 combinations of DCIA and non-DCIA curve number listed previously based upon the assumptions outlined in the previous paragraphs. Removal efficiencies were calculated for retention treatment volumes ranging from 0.25 inch to 4.0 inches of runoff in 0.25-inch increments. Removal efficiencies were also calculated for retention volumes based on the runoff from a specified rainfall depth ranging from 0.25-4.0 inches in 0.25-inch increments.

5.2.1.2 Design Criteria Based on Runoff Depth

Estimates of annual mass removal efficiencies for dry retention as a function of selected runoff depths, DCIA percentages, and non-DCIA curve numbers are given in Appendix D for each of the five meteorological zones. In general, the annual removal efficiency of a retention pond increases as the retention depth increases. Also, treatment efficiency decreases as the DCIA percentage and non-DCIA curve number increase. The removal efficiencies summarized in these tables are valid for all stormwater constituents since the efficiencies are based upon retention of a specific runoff volume within the retention pond. As a result, the stated removal efficiencies are assumed to be valid for all stormwater constituents, including total nitrogen, total phosphorus, TSS, and BOD.

A common design requirement for dry retention systems is a retention treatment volume of 0.5 inch of runoff or 1.25 inches of runoff from the impervious area, whichever is greater. Based on this criteria, projects with 40% impervious area or less will be required to provide retention for 0.5 inch of runoff, while projects with impervious percentages in excess of 40% will be regulated by 1.25 inch of runoff from the impervious area.

A summary of calculated annual mass removal efficiencies for a dry retention pond with a treatment volume equivalent to 0.5-inch of runoff is given in Table 5-6 for each of the five meteorological zones over a wide range of DCIA percentages and non-DCIA curve numbers. In general, annual mass removal efficiencies of 80% or more, as required the Water Resource Implementation Rule (Chapter 62-40 FAC), are obtained with a treatment volume equivalent to 0.5 inches of runoff only for projects with low percentage DCIA and low non-DCIA curve number values. On a state-wide average, a removal efficiency of 80% can only be achieved at DCIA percentages of 25-35% or less and non-DCIA curve numbers of approximately 45-55 or less. An example of a development which would meet these characteristics is a single-family residential community constructed on HSG A soils with grass cover in fair to good condition. All developments with DCIA percentages and non-DCIA curve numbers in excess of these values will fail to meet the 80% removal criterion with a retention treatment volume equivalent to 0.5 inch of runoff.

A graphical comparison of estimated annual pollutant removal efficiencies obtained using 0.5 inch of dry retention in a hypothetical development with a DCIA percentage of 40% and a non-DCIA curve number of 70 is given in Figure 5-5. Annual removal efficiencies range from approximately 58-69% between the five meteorological zones. The lowest annual removal efficiencies would be obtained in the Panhandle area, with the highest annual removal pollutant efficiencies achieved in the Central areas.

TABLE 5-6
CALCULATED ANNUAL MASS REMOVAL EFFICENCY OF A DRY RETENTION POND
WITH A TREATMENT VOLUME EQUIVALENT TO 0.5-INCH OF RUNOFF

Panhandle (Zone 1)

NON-DCIA CN	PERCENT DCIA																			
	5	10	15	20	25	30	35	40	45	50	55	60	65	70	75	80	85	90	95	100
30	91.8	91.5	88.3	84.0	79.5	75.0	70.7	66.6	62.9	59.6	56.5	53.6	51.1	48.7	46.6	44.6	42.8	41.1	39.6	38.1
35	88.2	89.1	86.6	82.8	78.6	74.3	70.1	66.2	62.6	59.3	56.3	53.5	51.0	48.7	46.5	44.6	42.8	41.1	39.6	38.1
40	84.0	86.3	84.4	81.2	77.4	73.4	69.4	65.7	62.2	59.0	56.0	53.3	50.8	48.5	46.4	44.5	42.7	41.1	39.6	38.1
45	79.6	82.9	81.9	79.3	75.9	72.2	68.5	65.0	61.7	58.6	55.7	53.0	50.6	48.4	46.3	44.4	42.7	41.0	39.5	38.1
50	74.8	79.1	79.0	77.0	74.1	70.8	67.4	64.1	61.0	58.0	55.3	52.7	50.4	48.2	46.2	44.3	42.6	41.0	39.5	38.1
55	70.1	74.9	75.6	74.2	71.9	69.1	66.1	63.0	60.1	57.3	54.7	52.3	50.0	47.9	46.0	44.2	42.5	40.9	39.5	38.1
60	65.5	70.4	71.7	71.1	69.4	67.0	64.4	61.7	59.1	56.5	54.1	51.8	49.6	47.6	45.8	44.0	42.4	40.9	39.5	38.1
65	61.0	65.8	67.5	67.6	66.4	64.7	62.5	60.2	57.8	55.5	53.3	51.1	49.1	47.2	45.5	43.8	42.3	40.8	39.4	38.1
70	56.7	61.1	63.1	63.6	63.1	61.9	60.2	58.3	56.3	54.3	52.3	50.3	48.5	46.8	45.1	43.5	42.1	40.7	39.4	38.1
75	52.7	56.6	58.6	59.3	59.3	58.6	57.5	56.0	54.4	52.7	51.0	49.3	47.7	46.1	44.6	43.2	41.8	40.5	39.3	38.1
80	49.1	52.2	54.1	55.0	55.2	54.9	54.2	53.2	52.1	50.8	49.4	48.0	46.6	45.3	44.0	42.7	41.5	40.3	39.2	38.1
85	46.1	48.3	49.7	50.5	50.8	50.8	50.5	49.9	49.2	48.3	47.3	46.3	45.2	44.2	43.1	42.1	41.0	40.0	39.1	38.1
90	43.5	44.8	45.6	46.1	46.4	46.5	46.4	46.1	45.7	45.2	44.6	44.0	43.3	42.6	41.9	41.1	40.4	39.6	38.9	38.1
95	41.1	41.5	41.8	41.9	42.0	42.1	42.0	41.9	41.8	41.6	41.3	41.1	40.8	40.4	40.1	39.7	39.3	38.9	38.5	38.1
98	39.8	39.8	39.8	39.8	39.8	39.7	39.7	39.6	39.5	39.4	39.3	39.2	39.1	39.0	38.9	38.7	38.6	38.4	38.3	38.1

TABLE 5-6 -- CONTINUED
CALCULATED ANNUAL MASS REMOVAL EFFICIENCY OF A DRY RETENTION POND
WITH A TREATMENT VOLUME EQUIVALENT TO 0.5-INCH OF RUNOFF

Central (Zone 2)

NON-DCIA CN	PERCENT DCIA																			
	5	10	15	20	25	30	35	40	45	50	55	60	65	70	75	80	85	90	95	100
30	97.0	96.7	94.8	91.7	87.9	83.8	79.7	75.7	71.9	68.4	65.2	62.1	59.4	56.9	54.5	52.3	50.3	48.4	46.7	45.1
35	95.2	95.5	93.8	90.9	87.3	83.4	79.3	75.4	71.7	68.3	65.0	62.1	59.3	56.8	54.4	52.3	50.3	48.4	46.7	45.1
40	92.9	94.0	92.5	89.9	86.5	82.7	78.9	75.1	71.4	68.0	64.9	61.9	59.2	56.7	54.4	52.2	50.2	48.4	46.7	45.1
45	90.2	91.9	90.9	88.6	85.5	81.9	78.2	74.6	71.1	67.7	64.6	61.7	59.1	56.6	54.3	52.2	50.2	48.4	46.7	45.1
50	86.7	89.2	88.9	87.0	84.2	80.9	77.4	73.9	70.5	67.3	64.3	61.5	58.9	56.5	54.2	52.1	50.2	48.3	46.6	45.1
55	82.7	86.1	86.4	84.9	82.6	79.6	76.4	73.1	69.9	66.8	63.9	61.2	58.6	56.3	54.1	52.0	50.1	48.3	46.6	45.1
60	78.5	82.6	83.4	82.5	80.6	78.0	75.1	72.1	69.1	66.1	63.4	60.8	58.3	56.0	53.9	51.9	50.0	48.2	46.6	45.1
65	74.2	78.6	79.8	79.5	78.1	76.0	73.5	70.7	68.0	65.3	62.7	60.2	57.9	55.7	53.6	51.7	49.9	48.2	46.6	45.1
70	69.8	74.2	75.8	76.0	75.2	73.5	71.4	69.1	66.6	64.2	61.8	59.5	57.3	55.3	53.3	51.4	49.7	48.1	46.5	45.1
75	65.4	69.6	71.4	71.9	71.5	70.4	68.8	66.9	64.9	62.7	60.6	58.6	56.6	54.7	52.8	51.1	49.5	47.9	46.5	45.1
80	61.4	64.9	66.6	67.3	67.2	66.5	65.5	64.1	62.5	60.8	59.0	57.3	55.5	53.9	52.2	50.7	49.2	47.7	46.4	45.1
85	57.6	60.1	61.6	62.2	62.3	62.0	61.3	60.4	59.3	58.1	56.8	55.4	54.0	52.7	51.3	50.0	48.7	47.4	46.2	45.1
90	54.1	55.4	56.2	56.7	56.8	56.7	56.4	55.9	55.2	54.5	53.6	52.8	51.8	50.9	49.9	48.9	47.9	46.9	46.0	45.1
95	50.1	50.5	50.7	50.8	50.8	50.8	50.6	50.4	50.2	49.9	49.5	49.1	48.7	48.2	47.7	47.2	46.7	46.1	45.6	45.1
98	47.8	47.7	47.7	47.6	47.6	47.5	47.4	47.2	47.1	46.9	46.8	46.6	46.5	46.3	46.1	45.9	45.7	45.5	45.3	45.1

TABLE 5-6 -- CONTINUED
CALCULATED ANNUAL MASS REMOVAL EFFICIENCY OF A DRY RETENTION POND
WITH A TREATMENT VOLUME EQUIVALENT TO 0.5-INCH OF RUNOFF

Florida Keys (Zone 3)

NON-DCIA CN	PERCENT DCIA																			
	5	10	15	20	25	30	35	40	45	50	55	60	65	70	75	80	85	90	95	100
30	87.6	89.1	87.6	84.8	81.5	77.8	74.3	70.9	67.8	64.9	62.1	59.6	57.2	55.0	52.9	51.0	49.2	47.6	46.0	44.5
35	83.5	86.5	85.6	83.4	80.4	77.0	73.6	70.4	67.4	64.5	61.9	59.4	57.0	54.9	52.8	51.0	49.2	47.5	46.0	44.5
40	79.3	83.5	83.4	81.7	79.1	76.0	72.9	69.8	66.9	64.2	61.6	59.1	56.9	54.7	52.7	50.9	49.1	47.5	46.0	44.5
45	74.9	80.3	80.9	79.7	77.6	74.9	72.0	69.1	66.4	63.7	61.2	58.9	56.6	54.6	52.6	50.8	49.1	47.5	45.9	44.5
50	70.5	76.7	78.1	77.6	75.9	73.5	70.9	68.3	65.7	63.2	60.8	58.5	56.4	54.4	52.5	50.7	49.0	47.4	45.9	44.5
55	66.3	72.9	75.0	75.1	73.9	71.9	69.6	67.3	64.9	62.6	60.3	58.1	56.1	54.1	52.3	50.6	48.9	47.4	45.9	44.5
60	62.1	68.9	71.7	72.4	71.6	70.1	68.2	66.1	64.0	61.8	59.7	57.7	55.7	53.8	52.1	50.4	48.8	47.3	45.9	44.5
65	58.0	64.9	68.1	69.3	69.1	68.0	66.5	64.7	62.8	60.9	59.0	57.1	55.2	53.5	51.8	50.2	48.7	47.2	45.8	44.5
70	54.4	60.9	64.2	65.8	66.2	65.6	64.5	63.0	61.5	59.8	58.1	56.3	54.6	53.0	51.4	49.9	48.5	47.1	45.8	44.5
75	51.1	57.0	60.4	62.2	62.9	62.7	62.1	61.0	59.8	58.4	56.9	55.4	53.9	52.4	51.0	49.6	48.3	47.0	45.7	44.5
80	48.5	53.5	56.5	58.3	59.1	59.3	59.1	58.5	57.6	56.6	55.4	54.2	52.9	51.6	50.4	49.2	47.9	46.8	45.6	44.5
85	46.7	50.3	52.7	54.2	55.1	55.5	55.6	55.3	54.9	54.2	53.4	52.6	51.6	50.6	49.6	48.5	47.5	46.5	45.5	44.5
90	45.4	47.6	49.1	50.2	51.0	51.4	51.7	51.7	51.5	51.2	50.8	50.3	49.7	49.0	48.3	47.6	46.8	46.1	45.3	44.5
95	44.8	45.6	46.2	46.7	47.1	47.3	47.5	47.6	47.6	47.5	47.4	47.2	47.0	46.7	46.4	46.1	45.7	45.3	44.9	44.5
98	45.2	45.3	45.4	45.4	45.5	45.5	45.5	45.6	45.5	45.5	45.5	45.4	45.3	45.3	45.2	45.0	44.9	44.8	44.7	44.5

TABLE 5-6 -- CONTINUED
CALCULATED ANNUAL MASS REMOVAL EFFICENCY OF A DRY RETENTION POND
WITH A TREATMENT VOLUME EQUIVALENT TO 0.5-INCH OF RUNOFF

Coastal (Zone 4)

NON-DCIA CN	PERCENT DCIA																			
	5	10	15	20	25	30	35	40	45	50	55	60	65	70	75	80	85	90	95	100
30	94.0	94.2	92.1	88.8	84.8	80.5	76.3	72.4	68.6	65.2	62.0	59.1	56.4	53.9	51.7	49.5	47.6	45.8	44.1	42.6
35	91.1	92.3	90.7	87.7	84.0	79.9	75.9	72.0	68.4	65.0	61.9	59.0	56.3	53.9	51.6	49.5	47.6	45.8	44.1	42.6
40	87.8	90.0	88.9	86.4	82.9	79.1	75.3	71.5	68.0	64.7	61.6	58.8	56.2	53.8	51.5	49.4	47.5	45.7	44.1	42.6
45	84.0	87.2	86.8	84.7	81.6	78.1	74.5	70.9	67.5	64.3	61.3	58.6	56.0	53.6	51.4	49.4	47.5	45.7	44.1	42.6
50	79.9	84.0	84.3	82.7	80.1	76.9	73.5	70.2	66.9	63.9	61.0	58.3	55.8	53.5	51.3	49.3	47.4	45.7	44.1	42.6
55	75.6	80.4	81.4	80.4	78.2	75.4	72.3	69.2	66.2	63.3	60.5	57.9	55.5	53.2	51.1	49.2	47.3	45.6	44.0	42.6
60	71.3	76.5	78.1	77.6	75.9	73.6	70.9	68.0	65.2	62.5	59.9	57.4	55.1	53.0	50.9	49.0	47.2	45.6	44.0	42.6
65	67.1	72.4	74.4	74.5	73.3	71.4	69.1	66.6	64.1	61.6	59.2	56.9	54.7	52.6	50.6	48.8	47.1	45.5	44.0	42.6
70	63.0	68.1	70.3	70.8	70.2	68.9	67.0	64.9	62.7	60.5	58.3	56.1	54.1	52.1	50.3	48.6	46.9	45.4	43.9	42.6
75	59.2	63.7	65.9	66.7	66.6	65.7	64.4	62.7	60.9	59.0	57.1	55.2	53.3	51.5	49.8	48.2	46.7	45.2	43.8	42.6
80	55.8	59.4	61.4	62.3	62.4	61.9	61.1	59.9	58.6	57.1	55.5	53.9	52.3	50.7	49.2	47.8	46.4	45.0	43.8	42.6
85	52.7	55.2	56.7	57.5	57.7	57.6	57.1	56.4	55.5	54.5	53.3	52.1	50.8	49.6	48.3	47.1	45.9	44.7	43.6	42.6
90	49.7	51.1	52.0	52.5	52.8	52.8	52.6	52.2	51.7	51.1	50.3	49.6	48.7	47.9	47.0	46.1	45.2	44.3	43.4	42.6
95	46.7	47.1	47.4	47.5	47.6	47.6	47.5	47.3	47.1	46.8	46.5	46.2	45.8	45.4	44.9	44.5	44.0	43.5	43.0	42.6
98	44.9	44.9	44.8	44.8	44.7	44.7	44.6	44.5	44.3	44.2	44.1	44.0	43.8	43.6	43.5	43.3	43.1	42.9	42.7	42.6

TABLE 5-6 -- CONTINUED

**CALCULATED ANNUAL MASS REMOVAL EFFICENCY OF A DRY RETENTION POND
WITH A TREATMENT VOLUME EQUIVALENT TO 0.5-INCH OF RUNOFF**

Southeast Coastal (Zone 5)

NON-DCIA CN	PERCENT DCIA																			
	5	10	15	20	25	30	35	40	45	50	55	60	65	70	75	80	85	90	95	100
30	88.6	89.9	87.9	84.5	80.5	76.4	72.3	68.5	65.1	61.9	58.9	56.2	53.7	51.4	49.3	47.3	45.5	43.8	42.2	40.8
35	84.1	86.8	85.6	82.8	79.3	75.4	71.6	68.0	64.6	61.5	58.7	56.0	53.6	51.3	49.2	47.3	45.5	43.8	42.2	40.8
40	79.3	83.3	82.9	80.8	77.8	74.3	70.7	67.3	64.1	61.1	58.3	55.8	53.4	51.1	49.1	47.2	45.4	43.8	42.2	40.8
45	74.4	79.5	80.0	78.5	76.0	72.9	69.6	66.5	63.4	60.6	57.9	55.4	53.1	51.0	48.9	47.1	45.3	43.7	42.2	40.8
50	69.7	75.5	76.8	76.0	73.9	71.3	68.4	65.5	62.6	60.0	57.4	55.0	52.8	50.7	48.8	47.0	45.3	43.7	42.2	40.8
55	65.2	71.4	73.4	73.1	71.7	69.5	66.9	64.3	61.7	59.2	56.9	54.6	52.5	50.4	48.6	46.8	45.2	43.6	42.1	40.8
60	61.0	67.2	69.7	70.1	69.2	67.4	65.3	63.0	60.6	58.4	56.2	54.0	52.0	50.1	48.3	46.6	45.0	43.5	42.1	40.8
65	57.1	63.1	65.9	66.8	66.4	65.1	63.3	61.4	59.4	57.3	55.3	53.4	51.5	49.7	48.0	46.4	44.9	43.4	42.1	40.8
70	53.6	59.2	62.0	63.2	63.3	62.5	61.2	59.6	57.9	56.1	54.3	52.6	50.9	49.2	47.6	46.1	44.7	43.3	42.0	40.8
75	50.7	55.5	58.1	59.5	59.8	59.4	58.6	57.4	56.1	54.6	53.1	51.6	50.1	48.6	47.1	45.8	44.4	43.2	41.9	40.8
80	48.3	52.0	54.3	55.5	56.0	56.0	55.6	54.8	53.9	52.8	51.6	50.3	49.0	47.8	46.5	45.3	44.1	43.0	41.8	40.8
85	46.2	48.7	50.5	51.5	52.0	52.2	52.1	51.7	51.1	50.4	49.6	48.6	47.6	46.7	45.6	44.6	43.7	42.7	41.7	40.8
90	44.2	45.6	46.7	47.4	47.9	48.1	48.2	48.1	47.8	47.4	46.9	46.4	45.7	45.1	44.4	43.7	43.0	42.2	41.5	40.8
95	42.5	43.0	43.4	43.7	43.9	44.0	44.1	44.1	44.0	43.9	43.7	43.5	43.2	43.0	42.7	42.3	42.0	41.6	41.2	40.8
98	42.1	42.2	42.2	42.2	42.2	42.2	42.2	42.1	42.1	42.0	41.9	41.8	41.7	41.6	41.5	41.4	41.2	41.1	40.9	40.8

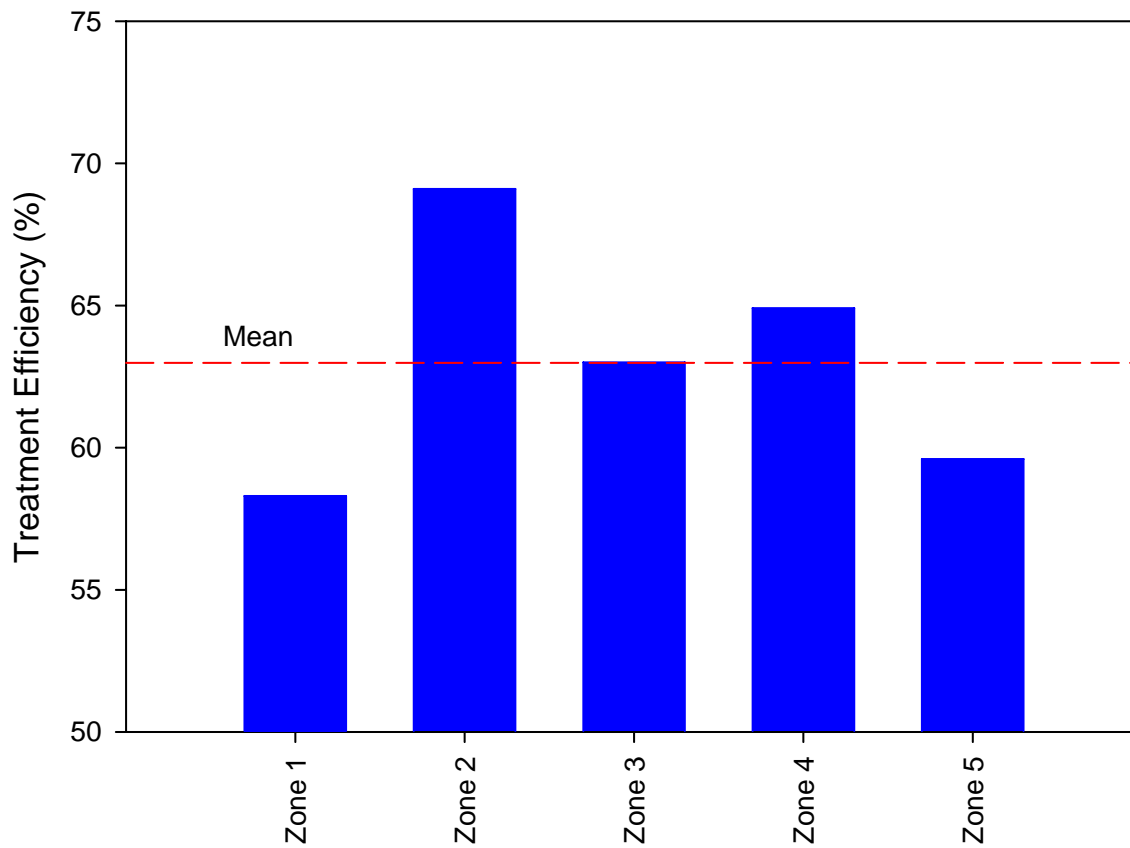

Figure 5-5. Calculated Annual Mass Removal Efficiencies for 0.5 inch of Dry Retention for a Development with 40% DCIA and a non-DCIA Curve Number of 70.

Isopleths for state-wide average removal efficiencies using 0.5 inch of dry retention for various DCIA percentages and non-DCIA curve numbers are illustrated on Figure 5-6 based on the combined data set for the 45 meteorological stations with hourly precipitation data. At low values for DCIA and non-DCIA curve numbers, removal efficiencies approach or exceed 80%. However, as the DCIA percentage and non-DCIA curve number increase, the removal efficiency for 0.5 inch of dry retention decreases rapidly.

For projects with impervious percentages in excess of 40%, the retention design criterion within the St., Johns River (for off-line system) and South Florida Water Management Districts becomes 1.25 inch of runoff from the impervious area. For a project with an impervious percentage of 80%, which is near the upper end of impervious coverage allowed under most zoning regulations, the required retention depth would be:

$$\text{Retention Depth} = 1.25 \text{ inches} \times 0.8 = 1.00 \text{ inch}$$

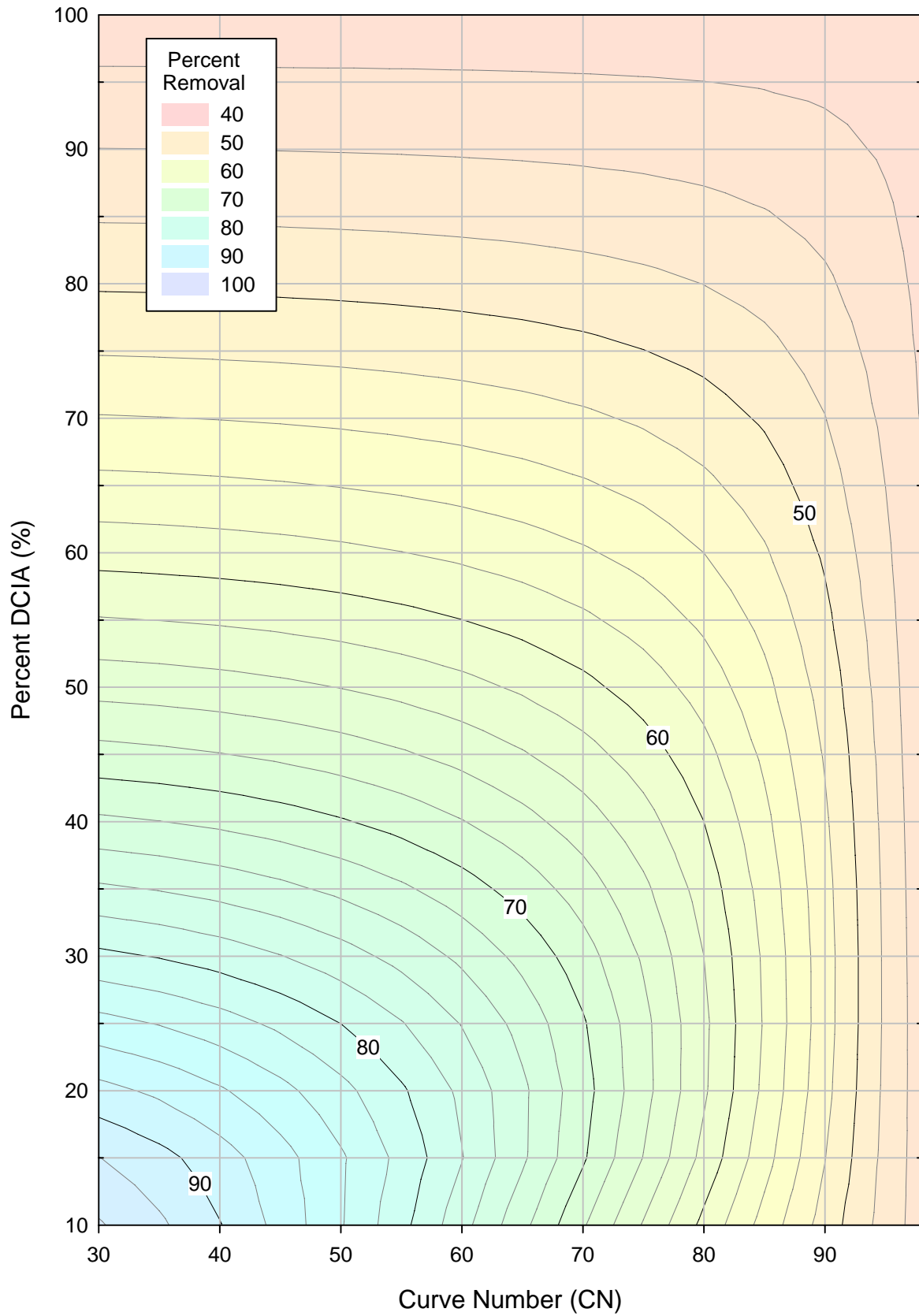

Figure 5-6. State-wide Average Removal Efficiencies for 0.5 inch of Dry Retention for Various DCIA Percentages and non-DCIA Curve Numbers.

Calculated annual mass removal efficiencies for a dry retention pond with a treatment volume equivalent to 1 inch of runoff are also listed in Appendix D. Assuming that the impervious area is 100% directly connected, the estimated annual mass removal efficiencies for this system are provided for each of the five meteorological zones in the column designated 80% DCIA. In general, the highest estimated annual mass removal efficiencies would occur on a project site with a low non-DCIA curve number, while the lowest anticipated annual mass removal efficiencies would occur in a system constructed with a high non-DCIA curve number. Estimated annual mass removal efficiencies for a treatment system with 1 inch of retention range from approximately 67.2-75.9% depending upon the particular meteorological region within the State. The highest estimated annual removal efficiencies appear to occur in the central and coastal areas, with the lowest annual mass removal efficiencies occurring in the southeast coastal and panhandle areas of the State.

In summary, with the exception of projects constructed on highly permeable soils with low impervious percentages, current design criteria based on retention of the first 0.5-inch of runoff or 1.25 inches from the impervious area fail to meet the target annual mass pollutant removal efficiency of 80% for stormwater management systems outlined in the Water Resource Implementation Rule (Chapter 62-40 FAC). Annual mass removal efficiencies for retention systems vary substantially within the State of Florida between the designated meteorological zones.

The SJRWMD requires additional dry retention treatment volume when the retention pond is constructed as an on-line system. For on-line systems, the SJRWMD design criteria become either (1) 1-inch of runoff over the entire site; or (2) 1.25-inch over the impervious area plus 0.5-inch over the entire site, whichever is greater. Estimated removal efficiencies for projects utilizing 1 inch of dry retention are summarized in Appendix D.1. Virtually all of the SJRWMD is located in the central zone (Zone 2). As seen in Appendix D.1., an annual removal efficiency of 80% can be achieved using 1 inch of dry retention for most projects with a DCIA percentage of approximately 60-65% or less and a non-DCIA curve number of 80 or less. If the site contains an impervious percentage in excess of 40%, the SJRWMD design criteria become 1.25-inch over the impervious area plus 0.5-inch over the entire site. Assuming a worst case impervious percentage of approximately 80%, this design criterion is equal to approximately 1.5 inch of dry retention. As seen in Appendix D.1, 1.5-inch of dry retention in Zone 2 is capable of providing the required 80% annual mass removal efficiency for all combinations of DCIA and non-DCIA curve number. This design criterion is the only current water management district dry retention design which meets the 80% annual load reduction goal for all possible combinations of DCIA and CN values.

5.2.1.3 Design Criteria Based on Runoff from a Specified Rainfall Event

Design criteria for retention basins in the Suwannee River and Southwest Florida Water Management Districts are referenced in terms of the runoff generated by a specific rainfall event, typically a 1-inch event. An evaluation of the anticipated annual performance efficiency of retention basins which are designed to provide treatment of runoff from a 1-inch rain event was performed using the continuous simulation methodology discussed previously.

A summary of calculated annual mass removal efficiencies of dry retention ponds with a treatment volume equivalent to the runoff from 1 inch of rainfall is given in Table 5-7. In general, the performance efficiency of retention ponds designed to this criterion appear to be relatively constant for each of the evaluated combinations of DCIA and curve number, compared with the trend of decreasing performance efficiency with increases in DCIA percentage and non-DCIA curve numbers observed for treatment systems designed according to a specified runoff volume. It is interesting to note that the anticipated removal efficiency of the dry retention system increases as the impervious percentage increases. This phenomenon occurs because the generated runoff volume from 1 inch of rainfall, which dictates the design treatment volume, increases as the percentage DCIA increases. As a result, removal efficiencies remain relatively constant, since the treatment volume changes in response to changes in project characteristics. The maximum anticipated removal efficiencies which can be achieved using a dry retention system with a treatment volume equivalent to 1 inch of rainfall are approximately 54-61%.

A graphical comparison of calculated annual mass removal efficiencies for dry retention of the runoff from 1 inch of rainfall for a hypothetical development with 40% DCIA and a non-DCIA curve number of 70 is given in Figure 5-7 for each of the five zones. Estimated annual mass removal efficiencies for this design range from approximately 50-57%, with the lowest removal efficiencies obtained in the Panhandle zone and the higher removal efficiencies obtained in the Central zone. This design criterion also falls short of the 80% pollutant removal efficiency specified by the Water Resource Implementation Rule (Chapter 62-40).

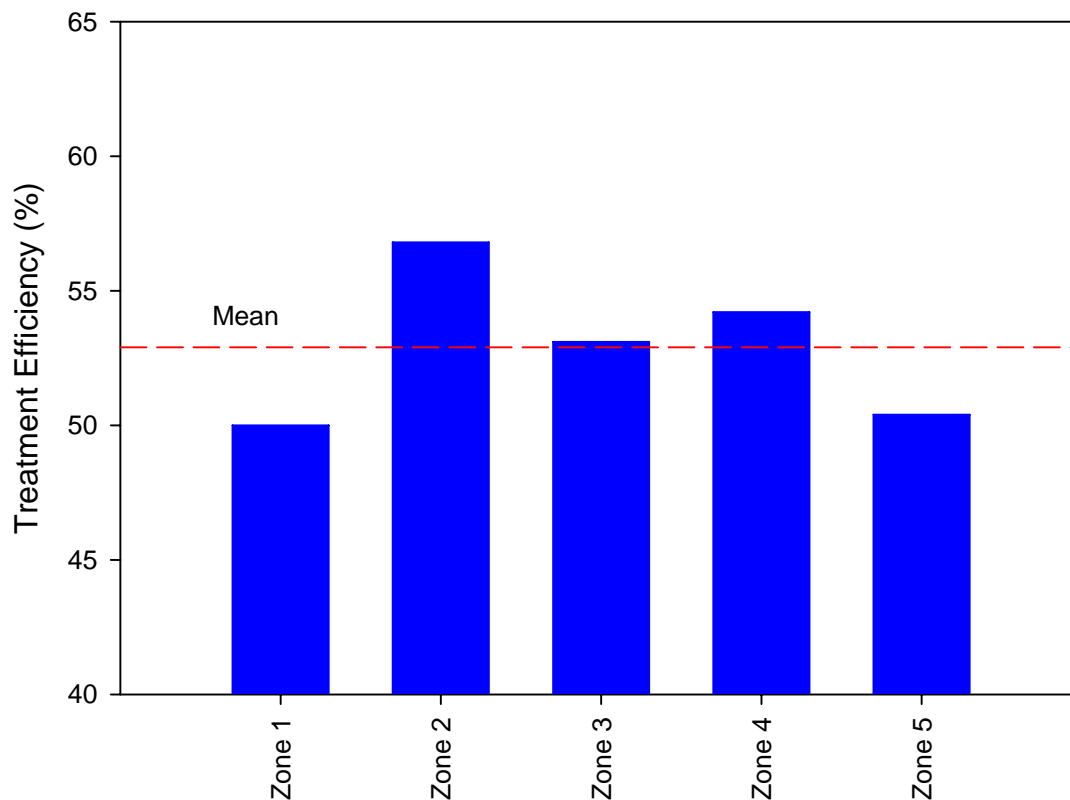

Figure 5-7. Calculated Annual Mass Removal Efficiencies for Dry Retention of the Runoff from 1 inch of Rainfall for a Development with 40% DCIA and a non-DCIA Curve Number of 70.

TABLE 5-7
CALCULATED ANNUAL MASS REMOVAL EFFICIENCY OF A DRY RETENTION POND
WITH A TREATMENT VOLUME EQUIVALENT TO THE RUNOFF FROM 1 INCH OF RAINFALL

Panhandle (Zone 1)

NON-DCIA CN	PERCENT DCIA																					
	0	5	10	15	20	25	30	35	40	45	50	55	60	65	70	75	80	85	90	95	100	
30	0.9	16.6	29.4	38.8	45.8	50.9	53.8	52.8	52.6	52.8	53.3	53.9	54.3	54.0	53.9	53.9	54.1	54.3	54.4	54.3	54.3	54.2
35	1.4	16.8	29.4	38.8	45.8	50.9	53.5	52.7	52.5	52.7	53.2	53.9	54.2	53.9	53.8	53.9	54.1	54.3	54.4	54.3	54.3	54.2
40	2.0	17.1	29.5	38.9	45.8	50.9	53.1	52.4	52.3	52.6	53.1	53.8	54.1	53.9	53.8	53.9	54.0	54.3	54.4	54.3	54.3	54.2
45	2.9	17.5	29.6	38.9	45.8	50.9	52.6	52.1	52.1	52.4	53.0	53.7	54.0	53.8	53.7	53.8	54.0	54.3	54.4	54.3	54.3	54.2
50	4.0	18.0	29.8	39.0	45.8	51.0	52.0	51.7	51.8	52.2	52.9	53.6	53.8	53.6	53.6	53.8	54.0	54.2	54.3	54.3	54.3	54.2
55	5.2	18.6	30.1	39.1	45.8	51.0	51.3	51.2	51.4	52.0	52.7	53.5	53.6	53.5	53.5	53.7	53.9	54.2	54.3	54.2	54.2	54.2
60	6.8	19.5	30.5	39.3	45.9	50.8	50.4	50.6	51.0	51.7	52.5	53.3	53.4	53.3	53.4	53.6	53.8	54.2	54.3	54.2	54.2	54.2
65	8.7	20.5	31.0	39.5	46.0	49.4	49.5	49.9	50.5	51.3	52.2	53.1	53.0	53.1	53.2	53.5	53.8	54.1	54.2	54.2	54.2	54.2
70	11.0	21.9	31.7	39.9	46.3	47.7	48.3	49.1	50.0	50.9	51.9	52.7	52.7	52.8	53.0	53.3	53.7	54.0	54.2	54.2	54.2	54.2
75	13.9	23.8	32.8	40.5	44.7	46.0	47.1	48.2	49.3	50.5	51.6	52.1	52.2	52.5	52.8	53.1	53.5	54.0	54.1	54.1	54.1	54.2
80	18.0	26.7	34.5	40.0	42.5	44.3	45.8	47.2	48.6	49.9	51.0	51.3	51.7	52.0	52.5	52.9	53.4	53.9	54.0	54.1	54.1	54.2
85	23.8	30.9	35.1	38.3	40.9	43.0	44.8	46.4	48.0	49.3	49.9	50.5	51.0	51.5	52.1	52.6	53.2	53.7	53.8	54.0	54.0	54.2
90	30.0	33.5	36.4	38.9	41.0	42.9	44.7	46.4	47.3	48.2	49.0	49.7	50.4	51.1	51.7	52.4	53.0	53.4	53.7	53.9	53.9	54.2
95	39.2	40.9	42.2	43.3	44.3	45.3	46.2	47.0	47.8	48.6	49.3	50.0	50.7	51.3	52.0	52.5	52.8	53.2	53.6	53.9	53.9	54.2
98	47.2	47.7	48.2	48.7	49.1	49.6	50.0	50.4	50.8	51.2	51.6	51.9	52.2	52.4	52.7	53.0	53.2	53.5	53.7	54.0	54.0	54.2

TABLE 5-7 -- CONTINUED
CALCULATED ANNUAL MASS REMOVAL EFFICIENCY OF A DRY RETENTION POND
WITH A TREATMENT VOLUME EQUIVALENT TO THE RUNOFF FROM 1 INCH OF RAINFALL

Central (Zone 2)

NON-DCIA CN	PERCENT DCIA																					
	0	5	10	15	20	25	30	35	40	45	50	55	60	65	70	75	80	85	90	95	100	
30	0.5	16.1	30.0	41.0	49.2	55.5	60.5	59.8	59.2	59.2	59.6	60.2	60.9	60.9	60.6	60.5	60.6	60.8	61.1	61.1	61.0	61.0
35	0.9	16.3	30.1	41.0	49.2	55.5	60.5	59.7	59.1	59.1	59.5	60.1	60.9	60.8	60.6	60.5	60.6	60.8	61.1	61.1	61.0	61.0
40	1.4	16.6	30.1	41.0	49.2	55.5	60.5	59.5	59.0	59.0	59.5	60.1	60.9	60.8	60.6	60.5	60.6	60.8	61.1	61.1	61.0	61.0
45	2.0	16.9	30.3	41.0	49.2	55.5	60.5	59.2	58.8	58.9	59.4	60.0	60.8	60.7	60.5	60.4	60.5	60.8	61.0	61.1	61.0	61.0
50	2.8	17.4	30.5	41.1	49.2	55.5	59.9	58.9	58.5	58.7	59.2	59.9	60.8	60.6	60.4	60.4	60.5	60.7	61.0	61.1	61.0	61.0
55	3.8	17.9	30.7	41.2	49.3	55.6	59.3	58.4	58.2	58.5	59.1	59.8	60.7	60.5	60.3	60.3	60.5	60.7	61.0	61.1	61.0	61.0
60	5.0	18.7	31.1	41.4	49.4	55.6	58.4	57.9	57.8	58.2	58.9	59.7	60.6	60.3	60.2	60.2	60.4	60.7	61.0	61.1	61.0	61.0
65	6.7	19.7	31.7	41.7	49.5	55.7	57.4	57.2	57.4	57.9	58.6	59.5	60.3	60.1	60.0	60.1	60.3	60.6	61.0	61.1	61.0	61.0
70	8.9	21.2	32.4	42.1	49.8	55.8	56.2	56.3	56.8	57.5	58.3	59.3	60.0	59.8	59.8	60.0	60.2	60.5	60.9	61.0	61.0	61.0
75	11.8	23.2	33.6	42.7	50.1	54.4	54.7	55.3	56.0	56.9	57.9	59.0	59.5	59.5	59.6	59.8	60.1	60.5	60.9	61.0	61.0	61.0
80	16.1	26.2	35.5	43.7	50.6	51.9	52.9	54.0	55.1	56.2	57.4	58.6	58.8	59.0	59.2	59.5	59.9	60.3	60.8	60.9	61.0	61.0
85	22.5	31.0	38.8	45.0	47.5	49.5	51.1	52.6	54.1	55.5	56.8	57.6	58.0	58.3	58.7	59.2	59.7	60.2	60.7	60.9	61.0	61.0
90	32.5	37.5	41.0	43.8	46.2	48.3	50.2	51.9	53.5	55.0	55.7	56.4	57.0	57.6	58.2	58.8	59.4	60.0	60.6	60.8	61.0	61.0
95	42.5	44.5	46.4	48.1	49.7	51.1	52.0	53.0	53.8	54.6	55.4	56.1	56.8	57.5	58.1	58.8	59.4	60.0	60.4	60.7	61.0	61.0
98	52.7	53.3	53.8	54.3	54.8	55.3	55.8	56.3	56.7	57.2	57.7	58.1	58.5	59.0	59.4	59.7	60.0	60.2	60.5	60.7	61.0	61.0

TABLE 5-7 -- CONTINUED
CALCULATED ANNUAL MASS REMOVAL EFFICIENCY OF A DRY RETENTION POND
WITH A TREATMENT VOLUME EQUIVALENT TO THE RUNOFF FROM 1 INCH OF RAINFALL

Florida Keys (Zone 3)

NON-DCIA CN	PERCENT DCIA																					
	0	5	10	15	20	25	30	35	40	45	50	55	60	65	70	75	80	85	90	95	100	
30	1.3	15.6	28.1	38.0	45.8	52.1	57.2	56.9	56.4	56.3	56.7	57.2	57.9	58.1	57.9	57.8	57.8	58.0	58.2	58.5	58.3	58.3
35	1.7	15.8	28.1	38.0	45.8	52.1	57.2	56.6	56.2	56.2	56.5	57.1	57.8	58.0	57.8	57.7	57.8	58.0	58.2	58.5	58.3	58.3
40	2.1	16.1	28.2	38.0	45.8	52.1	57.2	56.2	55.9	56.0	56.4	57.0	57.8	57.9	57.7	57.7	57.8	57.9	58.2	58.4	58.3	58.3
45	2.6	16.3	28.3	38.1	45.8	52.1	56.6	55.8	55.6	55.8	56.2	56.9	57.7	57.8	57.6	57.6	57.7	57.9	58.2	58.4	58.3	58.3
50	3.3	16.6	28.4	38.1	45.8	52.1	55.9	55.3	55.2	55.5	56.1	56.8	57.6	57.7	57.5	57.5	57.7	57.9	58.2	58.4	58.3	58.3
55	4.1	17.0	28.6	38.2	45.8	52.1	55.1	54.7	54.8	55.2	55.8	56.6	57.5	57.5	57.4	57.4	57.6	57.8	58.1	58.4	58.3	58.3
60	5.1	17.5	28.8	38.3	45.9	52.1	54.1	54.0	54.3	54.9	55.6	56.4	57.3	57.3	57.2	57.3	57.5	57.8	58.1	58.4	58.3	58.3
65	6.4	18.2	29.2	38.5	46.0	52.2	53.0	53.3	53.7	54.4	55.2	56.2	57.1	57.0	57.0	57.2	57.4	57.7	58.1	58.4	58.3	58.3
70	8.0	19.3	29.7	38.8	46.2	51.3	51.8	52.3	53.1	53.9	54.9	55.9	56.7	56.7	56.8	57.0	57.3	57.6	58.0	58.3	58.3	58.3
75	10.3	20.9	30.6	39.2	46.4	49.3	50.3	51.3	52.3	53.3	54.4	55.6	56.2	56.3	56.5	56.8	57.1	57.5	58.0	58.3	58.3	58.3
80	13.8	23.3	32.1	40.0	45.2	47.2	48.7	50.0	51.3	52.6	53.9	55.1	55.5	55.8	56.1	56.5	56.9	57.4	57.9	58.2	58.3	58.3
85	18.9	27.2	34.8	39.8	42.8	45.1	47.0	48.7	50.3	51.8	53.2	54.2	54.6	55.1	55.6	56.1	56.7	57.2	57.8	58.1	58.3	58.3
90	27.6	32.3	36.1	39.2	41.8	44.1	46.1	47.9	49.6	51.3	52.2	53.0	53.7	54.4	55.0	55.7	56.4	57.0	57.6	58.0	58.3	58.3
95	37.5	39.7	41.7	43.5	45.3	46.9	48.1	49.1	50.1	51.0	51.9	52.7	53.4	54.2	54.9	55.6	56.3	57.0	57.6	57.9	58.3	58.3
98	48.6	49.2	49.8	50.4	51.0	51.6	52.1	52.7	53.2	53.7	54.3	54.8	55.2	55.7	56.2	56.7	57.1	57.4	57.7	58.0	58.3	58.3

TABLE 5-7 -- CONTINUED
CALCULATED ANNUAL MASS REMOVAL EFFICIENCY OF A DRY RETENTION POND
WITH A TREATMENT VOLUME EQUIVALENT TO THE RUNOFF FROM 1 INCH OF RAINFALL

Coastal (Zone 4)

NON-DCIA CN	PERCENT DCIA																					
	0	5	10	15	20	25	30	35	40	45	50	55	60	65	70	75	80	85	90	95	100	
30	0.7	16.3	29.9	40.3	48.0	54.0	58.6	57.3	56.8	56.9	57.3	58.0	58.7	58.4	58.2	58.2	58.3	58.5	58.8	58.7	58.6	58.6
35	1.1	16.5	29.9	40.3	48.0	54.0	58.3	57.1	56.7	56.8	57.2	57.9	58.7	58.4	58.2	58.2	58.3	58.5	58.8	58.7	58.6	58.6
40	1.7	16.8	30.0	40.3	48.0	54.0	57.9	56.8	56.5	56.7	57.2	57.8	58.6	58.3	58.1	58.1	58.2	58.5	58.8	58.7	58.6	58.6
45	2.4	17.1	30.1	40.3	48.0	54.0	57.5	56.5	56.3	56.5	57.1	57.8	58.6	58.2	58.1	58.1	58.2	58.5	58.8	58.7	58.6	58.6
50	3.3	17.6	30.3	40.4	48.1	54.0	56.9	56.1	56.0	56.3	56.9	57.7	58.4	58.1	58.0	58.0	58.2	58.4	58.8	58.7	58.6	58.6
55	4.4	18.2	30.6	40.5	48.1	54.0	56.1	55.6	55.7	56.1	56.7	57.5	58.2	57.9	57.9	57.9	58.1	58.4	58.7	58.7	58.6	58.6
60	5.7	19.0	31.0	40.7	48.2	54.0	55.3	55.0	55.2	55.8	56.5	57.4	58.0	57.8	57.7	57.8	58.1	58.4	58.7	58.6	58.6	58.6
65	7.4	20.0	31.5	40.9	48.3	54.1	54.3	54.3	54.8	55.4	56.3	57.2	57.7	57.5	57.6	57.7	58.0	58.3	58.7	58.6	58.6	58.6
70	9.5	21.4	32.2	41.3	48.6	52.9	53.1	53.5	54.2	55.0	56.0	57.0	57.3	57.3	57.4	57.6	57.9	58.2	58.6	58.6	58.6	58.6
75	12.4	23.4	33.3	41.9	48.9	51.0	51.7	52.5	53.5	54.5	55.6	56.7	56.8	56.9	57.1	57.4	57.7	58.2	58.6	58.6	58.6	58.6
80	16.6	26.3	35.1	42.8	47.2	48.9	50.1	51.4	52.6	53.9	55.1	56.0	56.2	56.4	56.8	57.2	57.6	58.0	58.5	58.5	58.6	58.6
85	22.8	30.9	38.3	42.2	44.8	46.9	48.6	50.2	51.8	53.2	54.6	55.0	55.4	55.8	56.3	56.8	57.4	57.9	58.3	58.4	58.6	58.6
90	31.6	35.8	39.1	41.8	44.1	46.2	48.1	49.8	51.4	52.5	53.2	53.9	54.6	55.2	55.9	56.5	57.1	57.7	58.1	58.3	58.6	58.6
95	41.3	43.2	44.9	46.5	47.9	48.9	49.9	50.8	51.6	52.4	53.2	53.9	54.6	55.3	55.9	56.6	57.2	57.6	57.9	58.3	58.6	58.6
98	50.7	51.3	51.8	52.3	52.8	53.3	53.7	54.2	54.6	55.1	55.5	56.0	56.4	56.8	57.1	57.3	57.6	57.8	58.1	58.3	58.6	58.6

TABLE 5-7 – CONTINUED
CALCULATED ANNUAL MASS REMOVAL EFFICENCY OF A DRY RETENTION POND
WITH A TREATMENT VOLUME EQUIVALENT TO THE RUNOFF FROM 1 INCH OF RAINFALL

Southeast Coastal (Zone 5)

NON-DCIA CN	PERCENT DCIA																					
	0	5	10	15	20	25	30	35	40	45	50	55	60	65	70	75	80	85	90	95	100	
30	1.1	15.9	28.4	37.9	45.0	50.5	54.9	54.0	53.6	53.6	54.0	54.5	55.2	55.2	54.9	54.9	55.0	55.1	55.4	55.4	55.5	55.3
35	1.6	16.1	28.4	37.9	45.0	50.5	54.7	53.7	53.4	53.4	53.9	54.4	55.2	55.1	54.9	54.8	54.9	55.1	55.4	55.4	55.5	55.3
40	2.3	16.4	28.5	37.9	45.0	50.5	54.2	53.3	53.1	53.3	53.7	54.4	55.1	55.0	54.8	54.8	54.9	55.1	55.4	55.4	55.5	55.3
45	3.1	16.8	28.6	37.9	45.0	50.5	53.6	52.9	52.8	53.1	53.6	54.2	55.0	54.9	54.7	54.7	54.9	55.1	55.4	55.4	55.4	55.3
50	4.0	17.2	28.8	38.0	45.0	50.5	52.8	52.4	52.4	52.8	53.4	54.1	54.9	54.7	54.6	54.6	54.8	55.0	55.3	55.3	55.4	55.3
55	5.2	17.8	29.1	38.1	45.0	50.5	52.0	51.8	52.0	52.5	53.2	53.9	54.7	54.5	54.5	54.5	54.7	55.0	55.3	55.3	55.4	55.3
60	6.4	18.6	29.4	38.2	45.1	50.5	51.0	51.1	51.5	52.1	52.9	53.7	54.4	54.3	54.3	54.4	54.7	54.9	55.1	55.3	55.4	55.3
65	8.0	19.6	29.9	38.5	45.2	49.7	50.0	50.4	51.0	51.7	52.6	53.5	54.1	54.0	54.1	54.3	54.6	54.9	55.2	55.4	55.4	55.3
70	10.2	20.9	30.7	38.9	45.5	48.1	48.8	49.5	50.4	51.3	52.3	53.3	53.7	53.7	53.9	54.1	54.4	54.8	55.2	55.3	55.3	55.3
75	13.0	22.9	31.8	39.5	45.0	46.4	47.5	48.6	49.7	50.8	51.9	53.0	53.2	53.3	53.6	53.9	54.3	54.7	55.1	55.3	55.3	55.3
80	16.9	25.7	33.5	40.0	42.7	44.6	46.1	47.5	48.9	50.2	51.5	52.3	52.6	52.9	53.3	53.7	54.1	54.6	55.1	55.2	55.2	55.3
85	22.5	29.7	34.9	38.3	41.0	43.1	45.0	46.6	48.1	49.6	50.8	51.3	51.8	52.3	52.8	53.4	53.9	54.5	55.0	55.2	55.2	55.3
90	29.1	32.9	36.0	38.6	40.9	42.9	44.7	46.4	47.9	48.9	49.7	50.4	51.1	51.8	52.4	53.1	53.7	54.3	54.8	55.1	55.1	55.3
95	38.4	40.1	41.8	43.4	44.5	45.5	46.5	47.4	48.2	49.0	49.8	50.5	51.2	51.9	52.5	53.2	53.8	54.3	54.7	55.0	55.0	55.3
98	47.4	47.9	48.4	48.9	49.4	49.9	50.4	50.8	51.3	51.7	52.1	52.6	53.0	53.4	53.8	54.1	54.3	54.6	54.8	55.1	55.1	55.3

A comparison of annual mass removal efficiencies for dry retention systems designed for treatment of 0.5 inch of runoff or the runoff from 1 inch of rainfall, based upon a hypothetical development with 40% DCIA and a non-DCIA curve number of 70, is given in Figure 5-8. For each of the five meteorological zones, dry retention treatment for 0.5 inch of runoff provides a higher level of annual mass removal than criteria designed to treat the runoff from 1 inch of rainfall on the developed site.

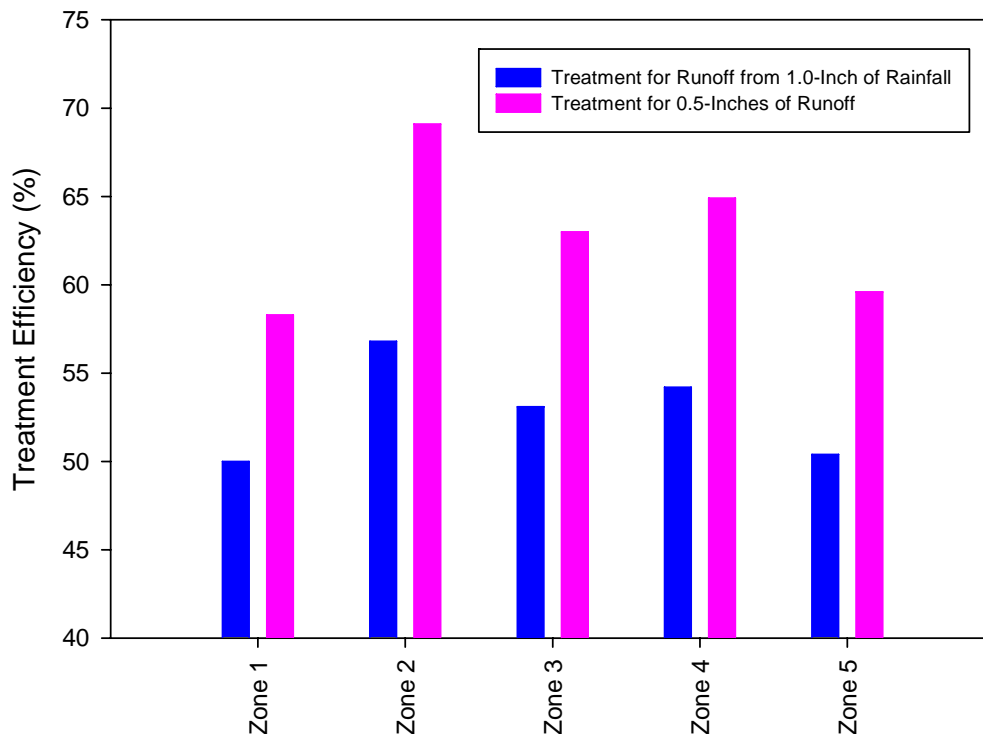

Figure 5-8. Comparison of Annual Mass Removal Efficiencies for Dry Retention Systems Designed for Treatment of 0.5 inch of Runoff or the Runoff from 1 inch of Rainfall.

5.2.2 Wet Detention

Wet detention stormwater treatment systems are referenced by the St. Johns River, Suwannee River, Southwest Florida, and South Florida Water Management Districts. However, detailed design criteria which references residence time and pond depth are provided by only the St. Johns River and South Florida Water Management Districts. The design criteria established by the St. Johns River Water Management District provides for wet detention ponds with relatively short residence times, typically ranging from 14-21 days, during wet season conditions. Ponds designed in the St. Johns River Water Management District are also relatively shallow, with a maximum depth of 12 ft. The South Florida Water Management District does not reference a specific criterion for residence time. However, the District recommends that 25-50% of the pond area be greater than 12 ft in depth which tends to create ponds with substantially longer residence times than those designed within the St. Johns River Water Management District.

Each of the four water management districts mentioned previously provides calculations for a treatment volume associated with the wet detention system. This treatment volume is often referred to as the “water quality volume” since the criteria are similar to the water quality treatment criteria for dry retention or dry detention. However, research on wet detention ponds clearly indicates that the most significant factor impacting the performance efficiency of a wet detention pond is the residence time within the system - specifically, the volume of the permanent pool with respect to the volume of runoff entering the pond (Toet, et al., 1990; Harper and Herr, 1993; Rushton, et al., 1995; and DB Environmental, 2005). Since the specified treatment volumes are negligible in comparison to the permanent pool volume contained within the wet detention pond, the treatment volume criteria primarily regulates the drawdown characteristics of the wet detention pond and has little impact on the overall water quality performance efficiency of the system.

Residence time within a wet detention pond is determined by the relationship between the permanent pool volume and the annual runoff inputs, as follows:

$$\text{Detention Time, } t_d \text{ (days)} = \frac{PPV}{RO} \times \frac{365 \text{ days}}{\text{year}}$$

where:

PPV = permanent pool volume (ac-ft)

RO = annual runoff inputs (ac-ft/yr)

For purposes of this calculation, the permanent pool volume is considered to include the total volume of water within the pond below the control elevation.

Criteria related to residence time and pond depth are not included in specific design criteria outlined by the Suwannee River or Southwest Florida Water Management Districts. Wet detention ponds designed in these districts could conceivably have a wide range of detention times and associated performance efficiencies, with some ponds approaching design criteria similar to that used in the St. Johns River Water Management District and other ponds approaching design criteria utilized in the South Florida Water Management District. As a result, estimates of the anticipated performance efficiency of wet detention systems designed in the St. Johns River and South Florida Water Management Districts will be presented in this section, with the anticipated efficiency of wet detention systems designed in the Suwannee River and Southwest Florida Water Management Districts likely to fall somewhere in between.

5.2.2.1 SJRWMD Design Criteria

Wet detention ponds designed according to St. Johns River Water Management District (SJRWMD) criteria are characterized by relatively short residence times, ranging from approximately 14-21 days under wet season conditions. Virtually all existing research studies on wet detention systems, as summarized in Table 5-2, have been performed on shallow ponds with relatively short residence times. Six of the eight studies summarized in Table 5-2 are located in the St. Johns River Water Management District, although designs for some of the earlier studies may be different from current design criteria.

A summary of estimated performance efficiencies of wet detention ponds designed according to SJRWMD criteria is given in Table 5-8. The values summarized in this table reflect the overall mean treatment efficiencies for wet detention systems summarized in Table 5-2. The values summarized in Table 5-8 correspond closely to performance efficiencies measured by Harper and Herr (1993) for a wet detention pond constructed according to SJRWMD criteria. Based upon the estimated performance efficiency summarized in Table 5-8, with the possible exception of TSS, wet detention ponds designed according to SJRWMD criteria fail to meet the 80% removal criteria outlined in Chapter 62-40.

TABLE 5-8

**ESTIMATED PERFORMANCE EFFICIENCY
OF WET DETENTION PONDS DESIGNED
ACCORDING TO SJRWMD CRITERIA**

PARAMETER	ANNUAL MASS REMOVAL (%)
Total N	25
Total P	65
TSS	75-85
BOD	65-70

5.2.2.2 SFWMD Design Criteria

As discussed in a previous section, wet detention systems designed within the South Florida Water Management District (SFWMD) are often excavated to water depths of 20 ft or more. The SFWMD does not have any specific limitation on pond depth, and developers often dig deep wet detention ponds to provide additional fill for low areas within a development. This technique can result in ponds with substantially extended detention times, often in excess of 200 days.

Although more research has been performed on wet detention systems than other stormwater management systems used within the State of Florida, relatively few of these studies have evaluated the relationship between detention time and performance efficiency of the system. Only three of the studies summarized in Table 5-2 provide measurements of performance efficiency at designated detention times within the pond. The remaining studies lack either basic bathymetric information on the pond or estimates of annual runoff inputs, both of which are necessary to estimate pond detention time. Studies summarized in Table 5-2 which provide information on pond detention time are generally limited to a maximum residence time of 14 days. Virtually no significant research has been conducted specifically on wet detention ponds with extended residence times in excess of 100-200 days similar to those constructed in the South Florida Water Management District.

A number of urban lakes which serve as regional wet detention facilities have been evaluated by ERD as part of water quality improvement or stormwater management projects. Detailed hydrologic and nutrient budgets were performed on each of these waterbodies which typically included direct measurements of hydrologic inputs, characterization of stormwater inputs, evaluation of inputs from groundwater seepage and bulk precipitation, and evaluation of the fate of nitrogen and phosphorus inputs into these systems. Each of these studies included an estimate of the mean annual residence time within the waterbody, along with an estimate of annual mass removal for both nitrogen and phosphorus. Estimated detention times for the waterbodies evaluated in these studies range from 49-769 days. Since the evaluated waterbodies function as regional wet detention facilities, these studies provide useful information on the anticipated performance efficiency of wet ponds under extended detention time conditions.

A summary of studies relating mass removal of nitrogen and phosphorus as a function of detention time in wet detention pond is given in Table 5-9. The studies summarized in Table 5-2 include research performed by Rushton, et al. (1995) and DB Environmental (2005), along with additional studies performed by ERD or Harper, et al. on regional wet detention facilities with extended residence times. Nineteen studies are available which provide simultaneous estimates of detention time and phosphorus removal, with some of the studies providing data for more than one detention time. Thirteen studies provide estimates of nitrogen removal as a function of detention time.

The information contained in Table 5-9 was entered into a statistical database, and a linear regression analysis was conducted to evaluate relationships between removal of nitrogen and phosphorus as a function of residence time within wet ponds. Removal efficiencies for both total nitrogen and total phosphorus as a function of residence time were observed to exhibit curvilinear relationships, with a relatively rapid initial removal for both nutrients, followed by a slow gradual increase in removal efficiency over an extended period of time. Various curvilinear models were evaluated to determine the model which provided the best-fit for the relationship between removal efficiency and residence time based upon the data set summarized in Table 5-9.

TABLE 5-9

**SUMMARY OF STUDIES RELATING MASS
REMOVAL OF NITROGEN AND PHOSPHORUS AS A
FUNCTION OF DETENTION TIME IN WET PONDS**

DESCRIPTION	DETENTION TIME (days)	ANNUAL MASS REMOVAL (%)		SOURCE
		Total N	Total P	
Lake Lucerne	105	53	80	ERD (1991)
Tampa Detention Pond	2	33 ¹	62	Rushton, et al. (1997)
	5	16	57	
	14	63 ¹	90 ¹	
Lake Virginia	220	44	85	ERD (2000)
Lake Osceola	102	35	71	ERD (2000)
Lake Maitland	197	35	79	ERD (2000)
Lake Arrowhead	49	52	71	Harper, et al. (2000)
Lake McBride	168	54	76	Harper, et al. (2000)
Lake Tom John	114	34	68	Harper, et al. (2000)
Lake Morton	328	43	83	Harper, et al. (2002)
Lake Holden	427	38	87	ERD (2004)
Melbourne Detention Pond	1	4	20	DB Environmental (2005)
	7	33	56	
	14	36	65	
Lake May	204	39	68	ERD (2007)
Lake Shipp	544	47	87	ERD (2007)
Lake Lulu	464	--	92	ERD (2007)
Lake Butler	551	--	91	ERD (2007)
Lake Down	769	--	97	ERD (2007)
Wauseon Bay	183	--	77	ERD (2007)
Lake Tibet	298	--	80	ERD (2007)
Lake Sheen	79	--	74	ERD (2007)

1. Data outlier, not included in regression analyses

The relationship between removal efficiency of total phosphorus in wet detention ponds as a function of residence time is given in Figure 5-9. The removal efficiency of 90% for total phosphorus with a 14-day residence time, provided by Rushton, et al. (1995), was removed from the data set as an outlier due to substantially elevated values for the Student T and Cook's D parameters. The best-fit relationship for the remaining data was obtained using a second-order relationship involving the natural log of the detention time. The best-fit equation is provided on Figure 5-9 for the relationship between removal efficiency and residence time. This equation provides an extremely good fit between the two variables, with an R^2 of 0.897. This value indicates that residence time explains approximately 90% of the observed variability in removal efficiencies for total phosphorus in wet detention ponds. The remaining variability is probably explained by experimental errors involved in the various studies and differences in the chemical composition of phosphorus species entering the various ponds. In general, phosphorus species such as particulate phosphorus and soluble reactive phosphorus (SRP) are removed relatively rapidly in wet detention ponds, while organic phosphorus is removed at a substantially lower rate.

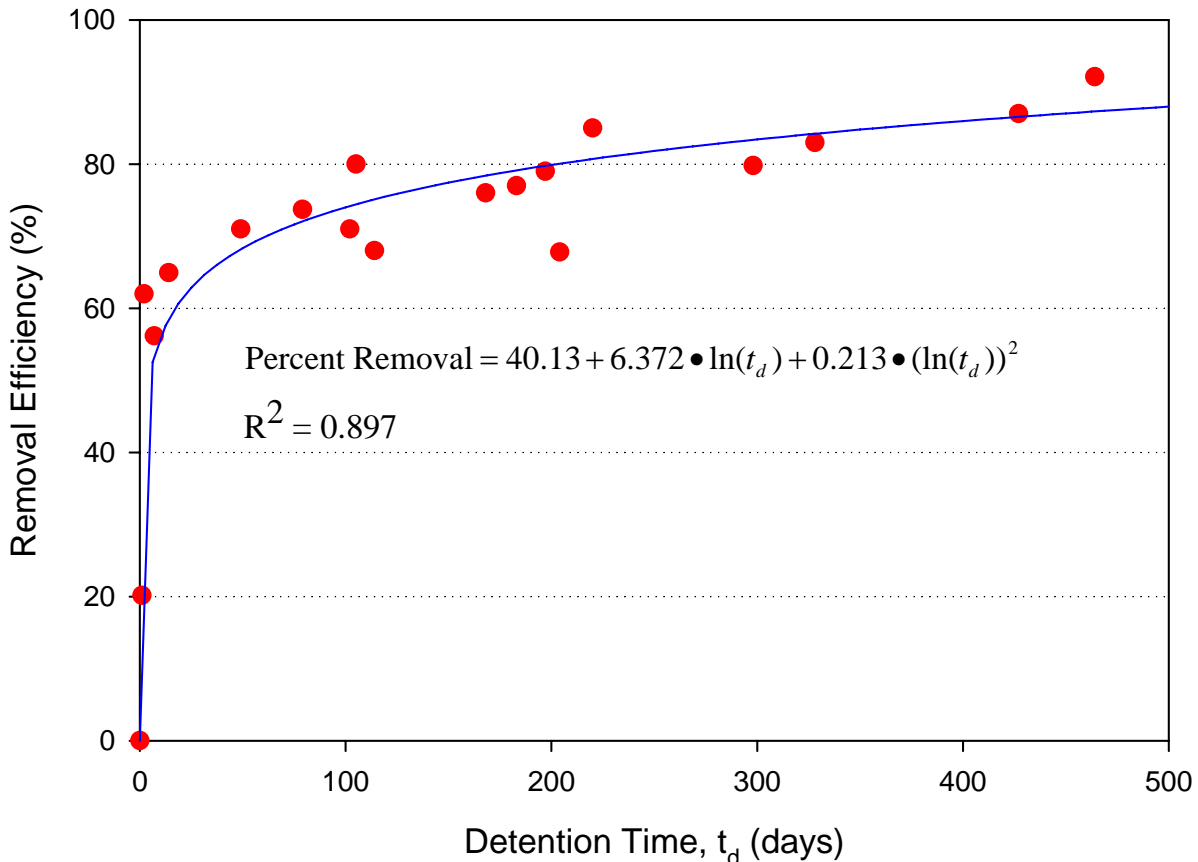

Figure 5-9. Removal Efficiency of Total Phosphorus in Wet Detention Ponds as a Function of Residence Time.

The relationship indicated on Figure 5-9 suggests that removal of phosphorus in wet detention ponds continues to occur, although at a progressively slower rate, with increases in residence time within the system. A removal efficiency of 80% can be achieved at a detention time of about 200 days. The upper limit for removal efficiencies in wet detention ponds appears to be approximately 90%, although removal efficiencies in excess of 90% were achieved at extended detention times in three of the 20 studies. At this point, total phosphorus concentrations within wet detention ponds appear to approach irreducible concentrations which reflect natural background phosphorus levels in surface waterbodies.

Relationships between detention time and removal efficiencies for total nitrogen in wet detention ponds are illustrated on Figure 5-10. The data points presented on this figure are based upon the referenced studies summarized in Table 5-9. The annual mass removal efficiency of 63% reported by Rushton, et al. (1995) for a wet pond with a detention time of 14 days and the removal efficiency of 33% for a 2-day detention time were eliminated from the data set as outliers due to elevated values for the Student T and Cook's D parameters.

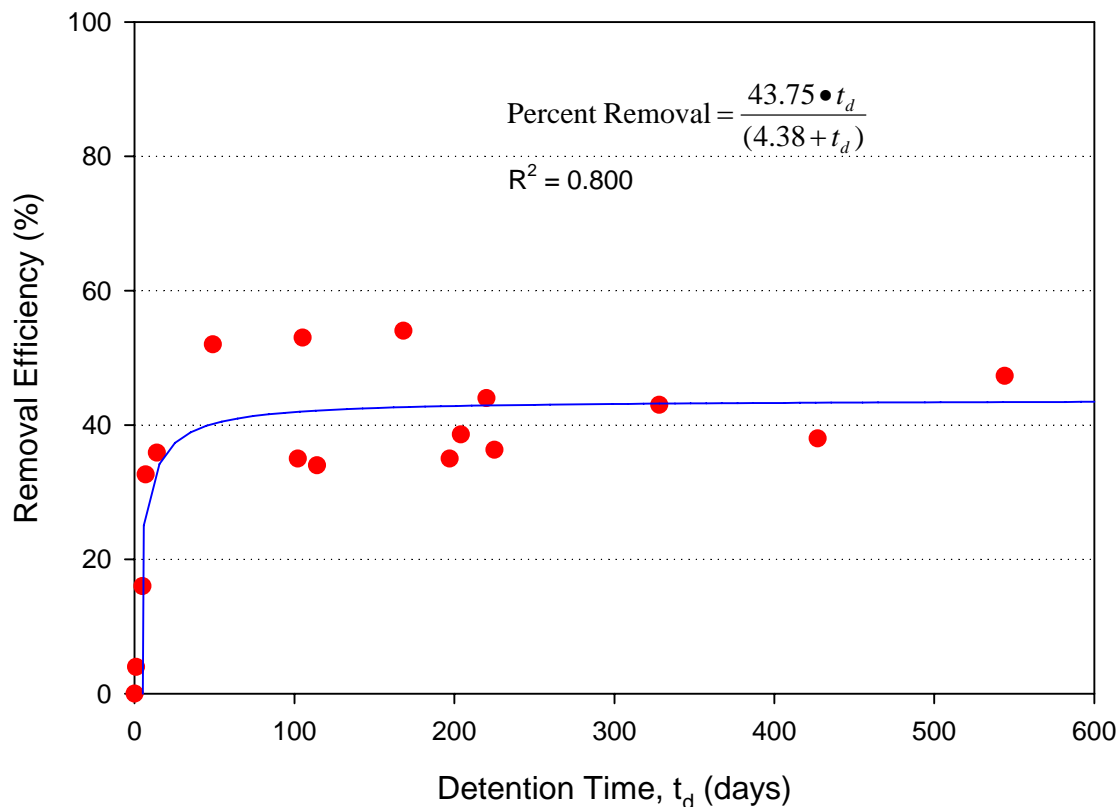

Figure 5-10. Removal Efficiency of Total Nitrogen in Wet Detention Ponds as a Function of Residence Time.

The best-fit for the relationship between removal efficiency and detention time for total nitrogen was obtained using a hyperbolic equation. The final version of this equation is summarized on Figure 5-10. The R^2 value of 0.800 suggests that detention time explains approximately 80% of the observed variability in removal efficiencies for total nitrogen in wet detention ponds. The remaining variability in removal efficiencies for total nitrogen is likely due to variability in methods of analysis between the listed studies as well as variability in the dominant nitrogen form present in the stormwater inflows. In general, inorganic forms of nitrogen (ammonia and NO_x) and particulate nitrogen are removed relatively rapidly in wet detention ponds. The initial rapid removal of nitrogen within the first 10-20 days, indicated on Figure 5-10, is probably a result of the rapid uptake of inorganic nitrogen and the settling of particulate species. Other forms of nitrogen, such as organic nitrogen, are removed at a substantially slower rate and are likely responsible for the dramatic slowdown in removal efficiency observed for total nitrogen after approximately 20-30 days.

The hyperbolic relationship summarized on Figure 5-10 indicates that a removal efficiency of approximately 40% can be achieved for total nitrogen in 50 days, with a maximum efficiency of approximately 45% at extended detention periods. The lack of additional removal efficiencies for total nitrogen observed at extended detention times is probably a reflection of either phosphorus limitation or that irreducible concentrations of total nitrogen have been achieved within the pond.

The relationships summarized in Figures 5-9 and 5-10 suggest that wet detention ponds designed in the South Florida Water Management District with extended detention times in excess of 200 days are likely to achieve approximately 80-85% removal for total phosphorus and 40-45% removal for total nitrogen on an annual basis. Although the estimated removal efficiencies for total phosphorus meet the goal of 80% removal for stormwater management systems outlined in the Water Resource Implementation Rule (Chapter 62-40 FAC), removal of total nitrogen in wet detention ponds, even at extended detention periods, still fails to meet the 80% goal.

5.2.3 Dry Detention

As discussed in Section 5.1.3, dry detention systems, constructed with or without filtration/underdrain systems, exhibit highly variable removal efficiencies which are influenced to a large extent by the relationships between the seasonal high groundwater table elevation and the pond bottom. Detention systems which provide infiltration for a large portion of the runoff inputs have exhibited substantially higher removal efficiencies than detention systems which are constructed at or below the groundwater table elevation. Because of the high degree of variability in removal efficiencies observed for dry detention systems, there is no presumption that these systems will meet the outlined goals of the Water Resource Implementation Rule for stormwater management systems. This fact has been recognized by the St. Johns River and South Florida Water Management Districts which now discourage the use of dry detention systems (with or without filtration/underdrains) in new development. Since other stormwater management options are available, such as dry retention or wet detention, which provide reliable and predictable pollutant removal efficiencies, dry detention systems should be eliminated as a common stormwater management technique within the State of Florida.

SECTION 6

RECOMMENDED MODIFICATIONS TO EXISTING STORMWATER DESIGN CRITERIA

This section provides an analysis of potential modifications to existing stormwater design criteria within the State of Florida to meet the performance objectives outlined in the Water Resource Implementation Rule (Chapter 62-40 FAC). This rule requires that stormwater management systems achieve at least an 80% reduction of the average annual load of pollutants that would cause or contribute to violations of State water quality standards. If the stormwater management system discharges to a designated OFW or other protected waterbody, the performance criteria increases to a 95% reduction. Based on the analyses presented in Section 5.2, with the exception of the SMRWMD design criteria for on-line dry retention, existing stormwater design criteria fail to consistently meet either the 80% or 95% target goals outlined in Chapter 62-40.

In addition to modifications required to achieve the 80% and 95% pollutant load reduction goals, an analysis is also provided in this section of the design criteria necessary to achieve a condition of no net increase in pollutant loadings for a developed site compared with loadings which would have reasonably been thought to discharge from the site under pre-development conditions. Implementation of these criteria would ensure that land developments do not cause a net degradation of water resources within the State. This objective is supported in Chapter 62-40.341 in the section titled “Stormwater Management Program”, which states that “the primary goals of the State’s Stormwater Management Program are to maintain, to the maximum extent practical, during and after construction and development, the pre-development stormwater characteristics of a site; ...”.

The analyses presented in the subsequent sections are provided for total nitrogen and total phosphorus which are two of the most common pollutants in urban runoff. Although total suspended solids (TSS) is also a significant constituent in stormwater runoff, the removal of TSS within stormwater management systems occurs at a much more rapid rate than is commonly observed for either total nitrogen or total phosphorus. Therefore, if a stormwater management system provides the required removal efficiency for both total nitrogen and total phosphorus, the system will easily provide the same pollutant removal efficiency for TSS.

Another common constituent in stormwater runoff is biochemical oxygen demand (BOD). Inputs of BOD into surface water can cause oxygen depletion, resulting in fish kills and changes in aquatic diversity. Upon entering an aquatic environment, organic matter is rapidly degraded by a variety of microorganisms within the water. The degradation and removal processes for BOD in surface waters have been well documented, and removal of BOD as a function of time has been shown to observe the following first-order equation:

$$BOD_t = BOD_o \times \exp(-K \times t)$$

where:

BOD_t	=	BOD at time, t (mg/l)
BOD_o	=	initial BOD (mg/l)
t	=	time (days)
K	=	decomposition constant (time ⁻¹)

BOD decomposition constants (K) in surface waters are temperature-dependent but are typically on the order of 0.1/day. A graphical representation of the theoretical removal of BOD as a function of time, based upon a decomposition constant of 0.1/day, is given in Figure 6-1. This relationship can be used to estimate the time required to achieve a certain BOD removal efficiency within a wet detention pond. A removal efficiency of approximately 80% is achieved for BOD after a residence time of approximately 15 days, with removal efficiencies in excess of 95% after approximately 30-35 days. As a result, the removal of BOD in aquatic systems occurs at a much more rapid rate than removal of total nitrogen or total phosphorus, as indicated in Figures 5-10 and 5-11. Therefore, if a stormwater management system provides the required removal efficiency for both total nitrogen and total phosphorus, the system will also easily provide the same pollutant removal efficiency for BOD.

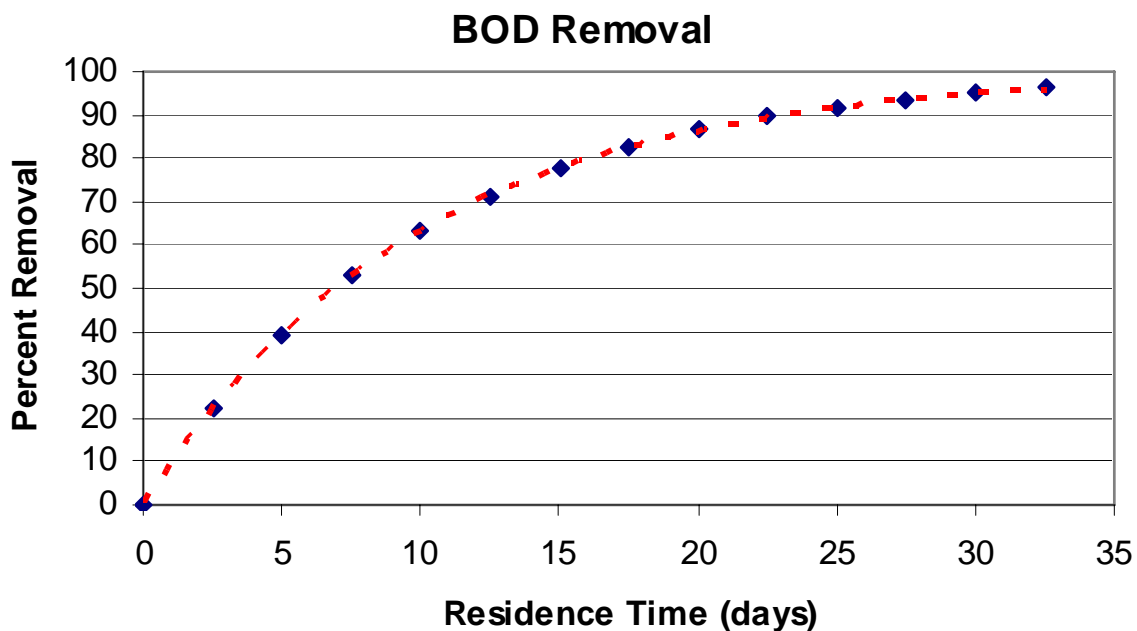

Figure 6-1. Theoretical Removal of BOD as a Function of Residence Time in a Wet Detention Pond.

The recommended design criteria discussed in this section include only dry retention and wet detention as potential stormwater management options. Based on the discussion presented in Section 5, these systems provide predictable and consistent pollutant removal efficiencies for a wide range of stormwater pollutants. For purposes of this analysis, the term “retention” can be used to mean a dry pond, swales, underground exfiltration, or any other practice which provides for recovery of a specified stormwater treatment volume by infiltration into the soil or evaporation. Dry detention stormwater management systems, either with or without filtration/underdrains, are not included as a viable stormwater management alternative in this section. As discussed previously, dry detention systems are characterized by highly variable removal efficiencies which depend heavily upon construction of the system with respect to the groundwater table elevation. Dry detention systems which have performed well in field evaluations have performed similar to dry retention basins, while poor removal efficiencies have been achieved in dry detention systems with little or no infiltration.

6.1 Design Criteria to Achieve 80% Removal

6.1.1 Dry Retention Systems

Since a first-flush effect is not assumed for this analysis, removal of 80% of the pollutant mass is achieved by retention of 80% of the annual runoff volume. Estimates of the retention volume required to achieve 80% removal of the annual stormwater runoff volume was calculated for each of the five meteorological zones and a variety of DCIA percentages and non-DCIA curve numbers. This information was extracted from the performance efficiency tables for dry retention provided in Appendix D which were utilized to find the required retention depth to achieve an annual treatment efficiency of 80% or more for each combination of DCIA percentage and non-DCIA curve number. If the treatment efficiency for a given combination of retention depth, DCIA percentage, and non-DCIA curve number exceeded 80%, the retention depth was interpolated using the next lower retention depth to achieve an estimated annual treatment efficiency of exactly 80% for each combination of DCIA percentage and non-DCIA curve number.

A summary of required retention depths to achieve an annual mass removal efficiency of 80% for dry retention systems is given in Table 6-1 for each of the five meteorological zones. The state-wide average is provided at the top of Table 6-1. On a state-wide average, retention depths necessary to achieve an annual removal efficiency of 80% range from 0.22-1.92 inches of runoff, depending upon the combination of DCIA percentage and non-DCIA curve number. The retention depths necessary to achieve 80% removal efficiency are lowest in the Central zone areas, with the highest retention depths required in the Panhandle areas.

A graphical illustration of state-wide average retention depths required to achieve an 80% annual removal efficiency as a function of DCIA percentage and non-DCIA curve number is given in Figure 6-2. Increases in the DCIA percentage and non-DCIA curve number clearly result in increases in the required retention depth necessary to achieve an 80% annual mass removal efficiency.

TABLE 6-1
REQUIRED RETENTION DEPTHS TO ACHIEVE AN
ANNUAL REMOVAL EFFICIENCY OF 80%

State-Wide Average

NDCIA CN	Percent DCIA																		
	10	15	20	25	30	35	40	45	50	55	60	65	70	75	80	85	90	95	100
30	0.24	0.28	0.37	0.45	0.51	0.59	0.67	0.75	0.82	0.90	0.98	1.05	1.13	1.21	1.29	1.37	1.44	1.52	1.60
35	0.26	0.30	0.39	0.46	0.53	0.60	0.68	0.75	0.83	0.91	0.98	1.06	1.14	1.21	1.29	1.37	1.45	1.52	1.60
40	0.29	0.33	0.41	0.48	0.54	0.62	0.69	0.77	0.84	0.92	0.99	1.07	1.14	1.22	1.30	1.37	1.45	1.52	1.60
45	0.34	0.37	0.44	0.50	0.56	0.64	0.71	0.78	0.85	0.93	1.00	1.08	1.15	1.23	1.30	1.38	1.45	1.53	1.60
50	0.43	0.44	0.48	0.53	0.59	0.67	0.74	0.80	0.87	0.95	1.02	1.09	1.16	1.24	1.31	1.38	1.45	1.53	1.60
55	0.54	0.52	0.54	0.58	0.64	0.70	0.77	0.83	0.90	0.97	1.04	1.11	1.18	1.25	1.32	1.39	1.46	1.53	1.60
60	0.68	0.62	0.62	0.64	0.69	0.75	0.81	0.86	0.93	0.99	1.06	1.13	1.19	1.26	1.33	1.40	1.46	1.53	1.60
65	0.82	0.74	0.72	0.73	0.77	0.81	0.86	0.91	0.97	1.03	1.09	1.15	1.21	1.28	1.34	1.41	1.47	1.54	1.60
70	0.98	0.88	0.85	0.84	0.86	0.89	0.93	0.97	1.02	1.07	1.13	1.18	1.24	1.30	1.36	1.42	1.48	1.54	1.60
75	1.12	1.04	0.99	0.97	0.97	0.99	1.02	1.05	1.09	1.13	1.18	1.23	1.28	1.33	1.38	1.43	1.49	1.55	1.60
80	1.26	1.19	1.14	1.12	1.11	1.11	1.13	1.15	1.18	1.21	1.24	1.28	1.32	1.37	1.41	1.46	1.50	1.55	1.60
85	1.39	1.33	1.29	1.26	1.25	1.25	1.25	1.26	1.28	1.30	1.33	1.35	1.38	1.42	1.45	1.49	1.52	1.56	1.60
90	1.50	1.46	1.43	1.41	1.40	1.39	1.39	1.39	1.40	1.41	1.42	1.44	1.46	1.48	1.50	1.52	1.55	1.57	1.60
95	1.58	1.56	1.55	1.54	1.53	1.53	1.53	1.53	1.53	1.53	1.53	1.54	1.54	1.55	1.56	1.57	1.58	1.59	1.60
98	1.59	1.59	1.58	1.58	1.58	1.58	1.58	1.58	1.58	1.58	1.58	1.58	1.59	1.59	1.59	1.59	1.60	1.60	1.60

TABLE 6-1 -- CONTINUED
REQUIRED RETENTION DEPTHS TO ACHIEVE AN
ANNUAL REMOVAL EFFICIENCY OF 80%

Panhandle (Zone 1)

NDCIA CN	Percent DCIA																		
	10	15	20	25	30	35	40	45	50	55	60	65	70	75	80	85	90	95	100
30	0.25	0.36	0.45	0.52	0.63	0.71	0.80	0.90	0.99	1.08	1.17	1.27	1.36	1.45	1.55	1.64	1.73	1.83	1.92
35	0.29	0.39	0.46	0.54	0.64	0.72	0.82	0.91	1.00	1.09	1.18	1.27	1.37	1.46	1.55	1.64	1.74	1.83	1.92
40	0.35	0.43	0.49	0.58	0.67	0.75	0.84	0.93	1.02	1.11	1.20	1.29	1.38	1.47	1.56	1.65	1.74	1.83	1.92
45	0.44	0.47	0.54	0.62	0.70	0.78	0.87	0.95	1.04	1.13	1.21	1.30	1.39	1.48	1.57	1.66	1.74	1.83	1.92
50	0.56	0.55	0.60	0.67	0.74	0.82	0.90	0.98	1.06	1.15	1.23	1.32	1.41	1.49	1.58	1.66	1.75	1.83	1.92
55	0.71	0.67	0.69	0.74	0.80	0.87	0.95	1.02	1.10	1.18	1.26	1.34	1.43	1.51	1.59	1.67	1.75	1.84	1.92
60	0.89	0.81	0.81	0.83	0.88	0.94	1.01	1.07	1.15	1.22	1.30	1.37	1.45	1.53	1.60	1.68	1.76	1.84	1.92
65	1.07	0.98	0.95	0.96	0.99	1.03	1.08	1.14	1.21	1.27	1.34	1.41	1.48	1.55	1.62	1.70	1.77	1.85	1.92
70	1.24	1.15	1.11	1.10	1.11	1.14	1.18	1.23	1.28	1.34	1.40	1.46	1.52	1.58	1.65	1.72	1.78	1.85	1.92
75	1.42	1.33	1.29	1.27	1.27	1.28	1.30	1.33	1.37	1.42	1.47	1.52	1.57	1.62	1.68	1.74	1.80	1.86	1.92
80	1.58	1.50	1.46	1.43	1.42	1.43	1.44	1.46	1.49	1.52	1.55	1.59	1.63	1.68	1.72	1.77	1.82	1.87	1.92
85	1.73	1.67	1.63	1.60	1.59	1.58	1.59	1.59	1.61	1.63	1.65	1.68	1.71	1.74	1.77	1.80	1.84	1.88	1.92
90	1.85	1.82	1.79	1.77	1.75	1.74	1.74	1.74	1.74	1.75	1.76	1.77	1.79	1.81	1.83	1.85	1.87	1.90	1.92
95	1.94	1.92	1.91	1.90	1.89	1.88	1.88	1.87	1.87	1.87	1.87	1.88	1.88	1.88	1.89	1.90	1.90	1.91	1.92
98	1.94	1.93	1.93	1.93	1.92	1.92	1.92	1.92	1.92	1.92	1.92	1.91	1.92	1.92	1.92	1.92	1.92	1.92	1.92

TABLE 6-1 -- CONTINUED
REQUIRED RETENTION DEPTHS TO ACHIEVE AN
ANNUAL REMOVAL EFFICIENCY OF 80%

Central (Zone 2)

NDCIA CN	Percent DCIA																		
	10	15	20	25	30	35	40	45	50	55	60	65	70	75	80	85	90	95	100
30	0.22	0.24	0.32	0.40	0.46	0.51	0.60	0.67	0.73	0.80	0.87	0.94	1.01	1.08	1.15	1.22	1.29	1.36	1.43
35	0.23	0.24	0.33	0.41	0.46	0.52	0.60	0.67	0.73	0.80	0.88	0.94	1.01	1.08	1.15	1.22	1.29	1.36	1.43
40	0.23	0.26	0.35	0.42	0.47	0.53	0.61	0.68	0.74	0.81	0.88	0.95	1.01	1.09	1.16	1.22	1.29	1.36	1.43
45	0.24	0.28	0.37	0.43	0.48	0.55	0.62	0.69	0.74	0.82	0.89	0.95	1.02	1.09	1.16	1.22	1.29	1.36	1.43
50	0.27	0.32	0.39	0.45	0.49	0.57	0.64	0.70	0.76	0.83	0.90	0.96	1.03	1.10	1.16	1.23	1.30	1.37	1.43
55	0.35	0.38	0.42	0.47	0.52	0.59	0.66	0.71	0.77	0.84	0.91	0.97	1.04	1.11	1.17	1.23	1.30	1.37	1.43
60	0.45	0.44	0.46	0.50	0.56	0.62	0.68	0.73	0.80	0.86	0.93	0.98	1.05	1.11	1.18	1.24	1.30	1.37	1.43
65	0.57	0.52	0.53	0.56	0.61	0.66	0.71	0.76	0.83	0.89	0.95	1.00	1.06	1.13	1.19	1.25	1.31	1.37	1.43
70	0.70	0.65	0.63	0.65	0.68	0.72	0.76	0.81	0.87	0.92	0.97	1.03	1.09	1.14	1.20	1.25	1.31	1.37	1.43
75	0.84	0.78	0.76	0.75	0.77	0.80	0.83	0.88	0.92	0.96	1.01	1.06	1.11	1.17	1.22	1.27	1.32	1.38	1.43
80	0.98	0.92	0.90	0.89	0.89	0.91	0.93	0.96	0.99	1.02	1.07	1.11	1.15	1.20	1.24	1.29	1.34	1.38	1.43
85	1.12	1.07	1.04	1.03	1.02	1.03	1.04	1.06	1.08	1.11	1.14	1.17	1.20	1.24	1.27	1.31	1.35	1.39	1.43
90	1.24	1.21	1.19	1.18	1.17	1.17	1.18	1.19	1.20	1.21	1.23	1.25	1.27	1.30	1.32	1.35	1.38	1.40	1.43
95	1.35	1.34	1.33	1.33	1.32	1.32	1.32	1.33	1.33	1.34	1.34	1.35	1.36	1.37	1.38	1.39	1.41	1.42	1.43
98	1.39	1.39	1.39	1.39	1.39	1.39	1.39	1.40	1.40	1.40	1.40	1.41	1.41	1.41	1.42	1.42	1.42	1.43	1.43

TABLE 6-1 -- CONTINUED
REQUIRED RETENTION DEPTHS TO ACHIEVE AN
ANNUAL REMOVAL EFFICIENCY OF 80%

Florida Keys (Zone 3)

NDCIA CN	Percent DCIA																		
	10	15	20	25	30	35	40	45	50	55	60	65	70	75	80	85	90	95	100
30	0.31	0.35	0.43	0.49	0.57	0.65	0.72	0.81	0.89	0.96	1.05	1.13	1.21	1.29	1.37	1.45	1.53	1.62	1.70
35	0.37	0.39	0.45	0.52	0.60	0.67	0.74	0.82	0.91	0.98	1.06	1.14	1.22	1.30	1.38	1.46	1.54	1.62	1.70
40	0.49	0.46	0.50	0.56	0.63	0.70	0.77	0.85	0.92	0.99	1.07	1.15	1.22	1.31	1.39	1.46	1.54	1.62	1.70
45	0.68	0.56	0.56	0.60	0.66	0.73	0.80	0.87	0.94	1.01	1.09	1.17	1.24	1.32	1.39	1.47	1.54	1.62	1.70
50	0.87	0.69	0.64	0.66	0.72	0.78	0.83	0.90	0.97	1.04	1.11	1.18	1.25	1.33	1.40	1.47	1.55	1.63	1.70
55	1.06	0.84	0.76	0.76	0.79	0.83	0.88	0.94	1.01	1.07	1.14	1.20	1.27	1.35	1.42	1.48	1.55	1.63	1.70
60	1.26	1.02	0.91	0.87	0.86	0.89	0.94	1.00	1.05	1.11	1.17	1.23	1.29	1.36	1.43	1.49	1.56	1.63	1.70
65	1.45	1.20	1.07	1.00	0.98	1.00	1.02	1.06	1.10	1.15	1.21	1.26	1.32	1.39	1.44	1.50	1.57	1.64	1.70
70	1.62	1.37	1.25	1.16	1.12	1.10	1.11	1.14	1.17	1.21	1.26	1.30	1.36	1.41	1.46	1.52	1.58	1.64	1.70
75	1.77	1.55	1.42	1.33	1.27	1.24	1.24	1.25	1.26	1.29	1.32	1.36	1.40	1.45	1.49	1.54	1.60	1.65	1.70
80	1.90	1.71	1.59	1.49	1.42	1.38	1.36	1.36	1.36	1.38	1.40	1.43	1.46	1.49	1.53	1.57	1.61	1.65	1.70
85	1.98	1.84	1.72	1.64	1.58	1.54	1.51	1.49	1.49	1.49	1.50	1.51	1.52	1.55	1.57	1.60	1.63	1.66	1.70
90	2.00	1.91	1.83	1.76	1.71	1.67	1.64	1.62	1.61	1.60	1.60	1.60	1.61	1.62	1.63	1.64	1.66	1.68	1.70
95	1.92	1.88	1.84	1.81	1.79	1.77	1.75	1.73	1.71	1.70	1.70	1.69	1.69	1.68	1.68	1.69	1.69	1.69	1.70
98	1.79	1.78	1.77	1.76	1.75	1.74	1.74	1.73	1.72	1.72	1.71	1.71	1.71	1.70	1.70	1.70	1.70	1.70	1.70

TABLE 6-1 -- CONTINUED
REQUIRED RETENTION DEPTHS TO ACHIEVE AN
ANNUAL REMOVAL EFFICIENCY OF 80%

Coastal (Zone 4)

NDCIA CN	Percent DCIA																		
	10	15	20	25	30	35	40	45	50	55	60	65	70	75	80	85	90	95	100
30	0.23	0.27	0.37	0.44	0.50	0.59	0.67	0.73	0.81	0.89	0.96	1.04	1.12	1.20	1.27	1.35	1.43	1.51	1.59
35	0.24	0.29	0.39	0.45	0.51	0.60	0.67	0.74	0.82	0.90	0.97	1.05	1.13	1.20	1.28	1.36	1.43	1.51	1.59
40	0.26	0.33	0.41	0.46	0.52	0.61	0.69	0.75	0.83	0.91	0.98	1.05	1.13	1.21	1.28	1.36	1.43	1.51	1.59
45	0.31	0.37	0.43	0.48	0.55	0.63	0.70	0.76	0.85	0.92	0.99	1.06	1.14	1.21	1.29	1.36	1.44	1.51	1.59
50	0.40	0.42	0.46	0.51	0.59	0.66	0.72	0.79	0.87	0.93	1.00	1.08	1.15	1.22	1.29	1.37	1.44	1.51	1.59
55	0.51	0.48	0.51	0.56	0.63	0.69	0.75	0.82	0.89	0.95	1.02	1.09	1.16	1.23	1.30	1.37	1.44	1.51	1.59
60	0.65	0.58	0.59	0.63	0.68	0.73	0.78	0.85	0.92	0.98	1.04	1.11	1.18	1.24	1.31	1.38	1.45	1.51	1.59
65	0.80	0.72	0.70	0.71	0.74	0.78	0.84	0.90	0.95	1.01	1.07	1.14	1.20	1.26	1.33	1.39	1.45	1.52	1.59
70	0.96	0.86	0.82	0.81	0.83	0.87	0.91	0.95	1.00	1.05	1.11	1.17	1.22	1.28	1.34	1.40	1.46	1.52	1.59
75	1.10	1.01	0.97	0.95	0.95	0.97	0.99	1.02	1.07	1.11	1.16	1.21	1.26	1.31	1.37	1.42	1.47	1.53	1.59
80	1.24	1.16	1.11	1.09	1.08	1.08	1.10	1.12	1.15	1.19	1.22	1.26	1.30	1.35	1.39	1.44	1.49	1.53	1.59
85	1.36	1.30	1.26	1.23	1.22	1.22	1.23	1.24	1.25	1.28	1.30	1.33	1.36	1.40	1.43	1.47	1.50	1.54	1.59
90	1.47	1.43	1.40	1.38	1.37	1.36	1.36	1.37	1.38	1.39	1.40	1.42	1.44	1.46	1.48	1.50	1.53	1.56	1.59
95	1.54	1.53	1.52	1.51	1.51	1.50	1.50	1.50	1.50	1.51	1.51	1.52	1.52	1.53	1.54	1.55	1.56	1.57	1.59
98	1.56	1.56	1.56	1.56	1.56	1.56	1.56	1.56	1.56	1.56	1.56	1.56	1.57	1.57	1.57	1.58	1.58	1.58	1.59

TABLE 6-1 -- CONTINUED

REQUIRED RETENTION DEPTHS TO ACHIEVE AN ANNUAL REMOVAL EFFICIENCY OF 80%

Southeast Coastal (Zone 5)

NDCIA CN	Percent DCIA																		
	10	15	20	25	30	35	40	45	50	55	60	65	70	75	80	85	90	95	100
30	0.26	0.36	0.44	0.50	0.59	0.68	0.76	0.85	0.93	1.02	1.10	1.19	1.28	1.36	1.45	1.54	1.62	1.71	1.80
35	0.33	0.40	0.46	0.53	0.62	0.70	0.78	0.87	0.95	1.03	1.12	1.20	1.29	1.37	1.46	1.54	1.62	1.71	1.80
40	0.41	0.45	0.50	0.57	0.65	0.73	0.81	0.89	0.97	1.05	1.13	1.22	1.30	1.38	1.46	1.55	1.63	1.71	1.80
45	0.55	0.52	0.56	0.63	0.69	0.76	0.84	0.92	0.99	1.07	1.15	1.23	1.31	1.39	1.47	1.55	1.63	1.72	1.80
50	0.71	0.63	0.65	0.69	0.75	0.81	0.88	0.95	1.03	1.10	1.18	1.25	1.33	1.41	1.48	1.56	1.64	1.72	1.80
55	0.89	0.78	0.76	0.78	0.82	0.87	0.93	1.00	1.06	1.13	1.21	1.28	1.35	1.42	1.50	1.57	1.64	1.72	1.80
60	1.07	0.94	0.89	0.88	0.91	0.95	1.00	1.05	1.11	1.17	1.24	1.31	1.37	1.44	1.51	1.58	1.65	1.73	1.80
65	1.25	1.11	1.04	1.02	1.02	1.04	1.07	1.12	1.17	1.23	1.28	1.34	1.40	1.47	1.53	1.60	1.66	1.73	1.80
70	1.41	1.28	1.20	1.16	1.15	1.15	1.17	1.20	1.24	1.29	1.33	1.39	1.44	1.50	1.56	1.61	1.67	1.74	1.80
75	1.57	1.44	1.36	1.31	1.29	1.28	1.29	1.30	1.33	1.36	1.40	1.44	1.49	1.54	1.58	1.63	1.69	1.74	1.80
80	1.70	1.59	1.52	1.47	1.43	1.41	1.41	1.42	1.43	1.45	1.48	1.51	1.54	1.58	1.62	1.66	1.71	1.75	1.80
85	1.80	1.72	1.66	1.61	1.57	1.55	1.54	1.54	1.54	1.55	1.57	1.59	1.61	1.63	1.66	1.69	1.73	1.76	1.80
90	1.87	1.81	1.77	1.73	1.71	1.69	1.67	1.66	1.66	1.66	1.67	1.67	1.69	1.70	1.72	1.73	1.75	1.77	1.80
95	1.88	1.85	1.84	1.82	1.81	1.79	1.79	1.78	1.77	1.77	1.77	1.77	1.77	1.77	1.77	1.78	1.78	1.79	1.80
98	1.83	1.82	1.82	1.81	1.81	1.81	1.80	1.80	1.80	1.80	1.80	1.79	1.79	1.79	1.79	1.79	1.80	1.80	1.80

Statewide Mean Retention Depth Needed to Achieve 80% Annual Mass Removal

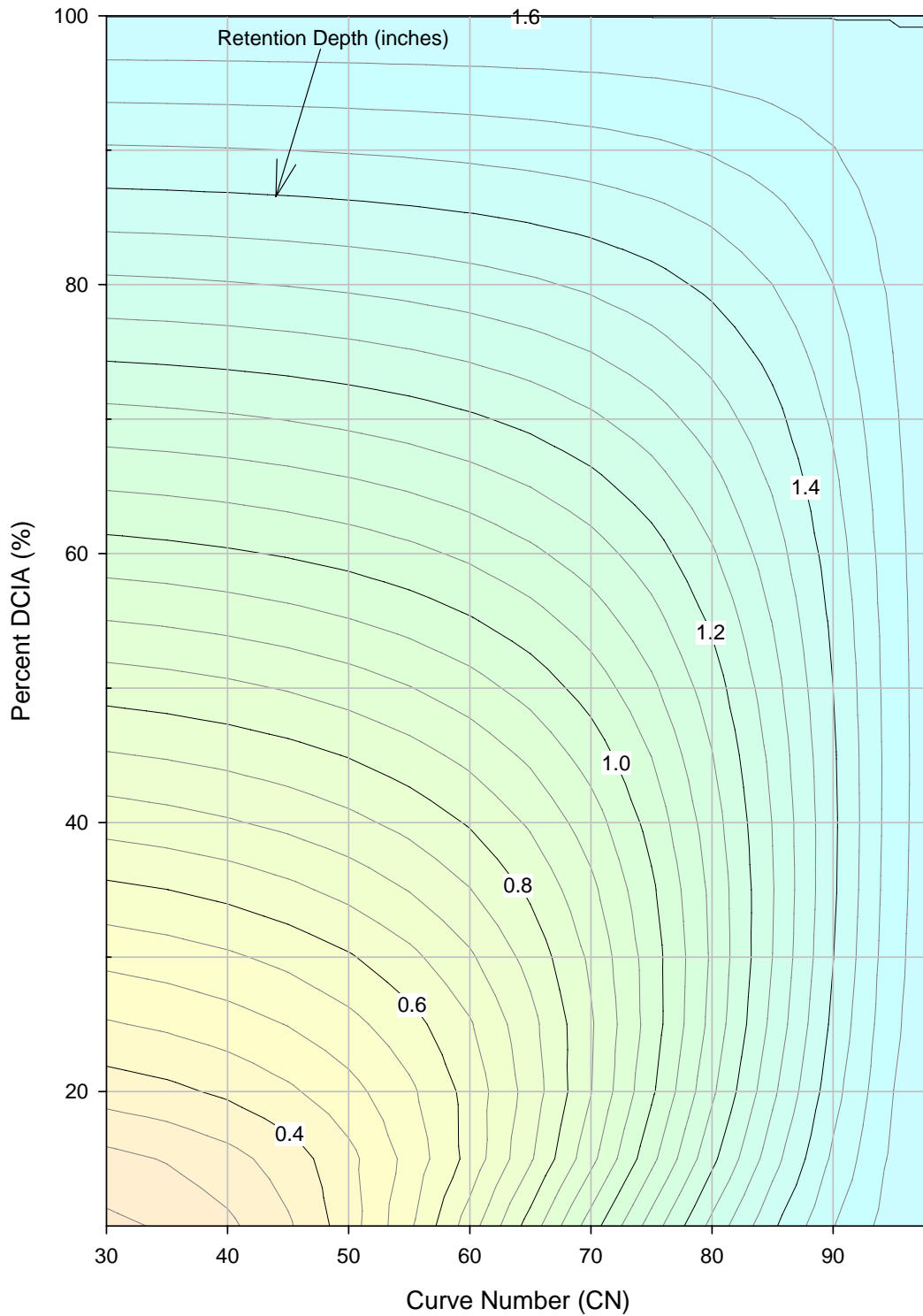

Figure 6-2. State-wide Average Variations in Required Dry Retention Depth for 80% Removal as a Function of DCIA Percentage and non-DCIA Curve Number.

Variations in required dry retention depth to achieve 80% removal in the Central zone are illustrated on Figure 6-3 as an example of an area with lower than average retention depth requirements. Required dry retention depths in the Central zone area range from approximately 0.22-1.43 inches depending upon the combination of DCIA percentage and non-DCIA curve number. Variations in required dry retention depth to achieve 80% removal in the Panhandle area are illustrated on Figure 6-4 as an example of an area with higher than average retention depth requirements. At high values for DCIA percentage and non-DCIA curve number, the retention depth required to achieve 80% removal is substantially greater in the Panhandle region than in the Central region. As discussed previously, these variations are primarily due to the differences in the distribution of typical rain events.

A summary of recommended design criteria for dry retention ponds to achieve an annual removal efficiency of 80% is given in Table 6-2. Recovery of the required treatment volume must be achieved within 72 hours or less, equivalent to the volume recovery period utilized for generation of the performance efficiency tables summarized in Appendix D. Ability of the pond to achieve this recovery rate must be certified by a registered geotechnical engineer. All side slopes and bottom areas of the pond must be seeded or sodded with water-tolerant grass species grown on sandy soils. If sod is used as the vegetative cover on the bottom of the pond, changes in permeability of the basin resulting from the sod must be included in evaluation of the recovery period for the pond. Inlets and outlets must be located as far apart as possible to prevent short-circuiting. Oil and grease skimmers must be provided at all outfall structures. Other requirements related to side slopes, fencing, maintenance berms, and access will adhere to applicable local agency criteria.

TABLE 6-2
RECOMMENDED DESIGN CRITERIA FOR
DRY RETENTION PONDS TO ACHIEVE 80%
ANNUAL REMOVAL EFFICIENCY

PARAMETER	DESIGN CRITERIA
Treatment Volume	Selected using Table 6-1 according to meteorological zone, DCIA percentage, and non-DCIA curve number
Recovery of Treatment Volume	72 hours (certified by registered professional engineer)
Side Slopes and Bottom	Seeded or sodded with water-tolerant grass species; if sod is used, changes in infiltration resulting from the sod must be considered
Inlet and Outlet	Located as far apart as possible to prevent short-circuiting
Oil and Grease Skimmers	Provided at outlet structure
Requirements Related to Side Slopes, Fencing, Maintenance Berms, and Access	According to applicable local or regulatory agency criteria

Retention Depth Needed to Achieve
80% Annual Mass Removal for Central Areas (Zone 2)

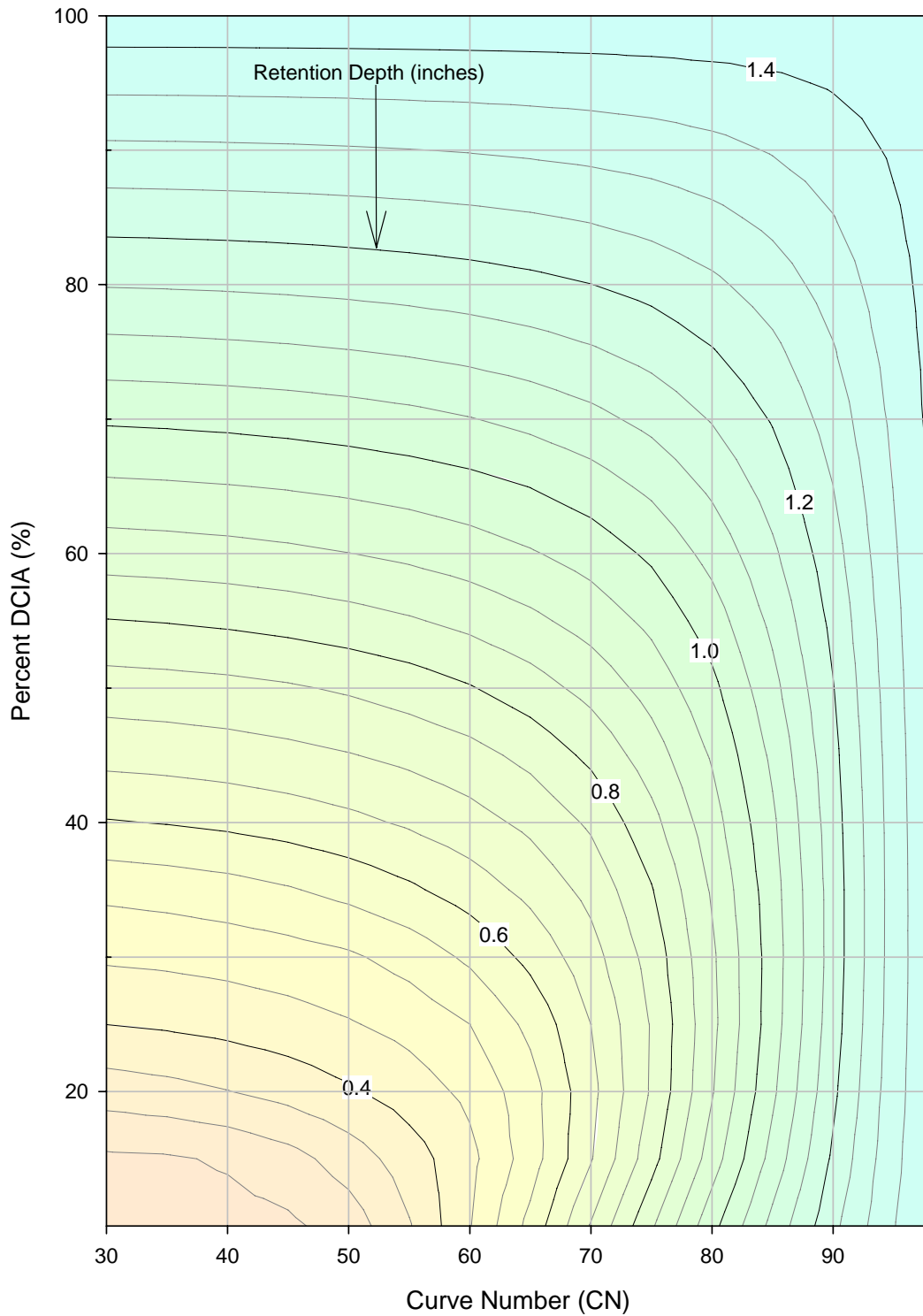

Figure 6-3. Variations in Required Dry Retention Depth to Achieve 80% Removal in the Central Zone Area (Zone 2).

Retention Depth Needed to Achieve
80% Annual Mass Removal for Panhandle Areas (Zone 1)

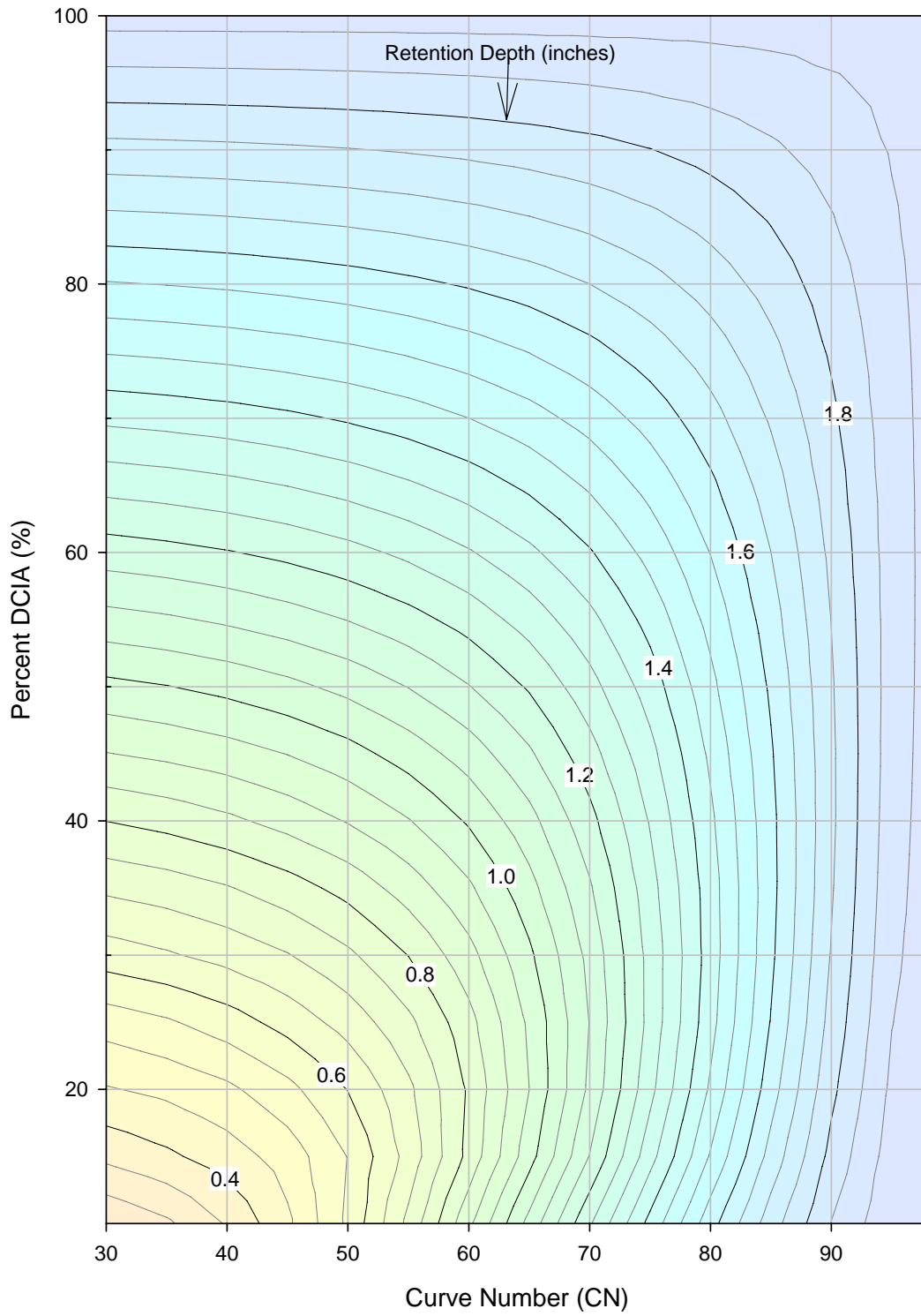

Figure 6-4. Variations in Required Dry Retention Depth to Achieve 80% Removal in the Panhandle Zone Area (Zone 1).

6.1.2 Wet Detention

Wet detention systems provide reliable and predictable pollutant removal efficiencies and can play a significant part in stormwater management for virtually any type of development. However, as discussed in Section 5.2, wet detention ponds with short detention times (14-21 days) fail to achieve the 80% pollutant removal efficiency for either total nitrogen or total phosphorus. Wet detention ponds designed with extended detention periods can achieve the 80% removal criteria for total phosphorus, but will fail to achieve this efficiency for total nitrogen. Therefore, if 80% removal is necessary for total nitrogen, wet detention ponds must be used as part of a treatment train approach to achieve the target removal efficiency for both nitrogen and phosphorus.

A summary of recommended design criteria for wet detention ponds is given in Table 6-3. Based upon the information presented previously, the most important factor in regulating the performance efficiency of a wet detention pond is the residence time for runoff inputs within the system. Assuming that short circuiting does not occur, residence time is determined primarily by the permanent pool volume, and this volume becomes the single most important design parameter for wet detention ponds. The required volume of the permanent pool can be calculated based upon the removal relationships presented previously in Figures 5-9 (total phosphorus) and 5-10 (total nitrogen). Design criteria are also listed for the treatment volume, which represents the water volume stored on top of the permanent pool during an individual rain event. Pond requirements for treatment volume and recovery time for the treatment volume are based upon current water management district criteria.

Design criteria for pond depth are based upon the anticipated depth of the anoxic zone within the pond based on the anticipated productivity of the pond. This concept is discussed further in Section 6.4. No restrictions are placed on the configuration of the pond, provided that the inlet and outlet from the system are located as far apart as possible to maximize travel path. In addition, it is recommended that at least 20% of the pond surface be planted with a littoral zone consisting of a combination of submergent and emergent aquatic vegetation. Creation of a littoral zone will create a more diverse environment and will probably enhance the overall performance efficiency of the wet detention system.

TABLE 6-3

**RECOMMENDED DESIGN CRITERIA
FOR WET DETENTION PONDS**

PARAMETER	DESIGN CRITERIA
Treatment Volume	1-inch runoff or 2.5 inch x impervious percent, whichever is greater (current SJRWMD and SFWMD criteria)
Recovery Time	Recover design capacity in 48-72 hours
Permanent Pool	Volume based on desired removal efficiency
Pond Depth/ Configuration/ Side Slopes	<u>Depth</u> : maximum depth cannot exceed anticipated depth of anoxia based on pond productivity <u>Configuration</u> : no restriction provided that the inlet and outlet are located as far apart as possible <u>Side Slopes</u> : 4:1 minimum
Littoral Zone	At least 20% of the pond surface

As indicated previously, wet detention systems must be utilized as part of a treatment train to achieve the required 80% removal efficiency specified under the Water Resource Implementation Rule (Chapter 62-40). When treatment systems are used in series as part of a treatment train, the efficiency of the overall treatment train can be calculated using the following equation:

$$\text{Overall Treatment Train Efficiency (decimal)} = \text{Eff}_1 + (1 - \text{Eff}_1) \times \text{Eff}_2 \quad (\text{Eq. 1})$$

where:

Eff_1 = efficiency of initial treatment system (decimal)

Eff_2 = efficiency of second treatment system (decimal)

After treatment in the initial system, a load reduction has occurred which is a function of the type of treatment provided. After migrating through the initial treatment system, the remaining load consists of mass which was not removed in the initial system. This mass is then acted upon by the second treatment system with an efficiency associated with the particular type of system used. The overall efficiency can then be calculated according to the above equation.

To achieve an overall annual mass load reduction of 80% using wet detention, a pre-treatment system must first be used to provide a significant portion of the desired pollutant removal effectiveness. For example, assume that a wet detention pond is designed with a detention period of approximately 50 days which is sufficient to achieve a removal efficiency of approximately 40% for total nitrogen. Utilizing the relationship summarized as Eq. 1, and assuming that the efficiency of the wet detention system for total nitrogen (40%) is represented by Eff_2 , the efficiency of the initial treatment system (Eff_1) would need to be 67% to achieve an overall treatment efficiency of 80%.

Depending upon the characteristics of the development and the meteorological region, achieving an initial 67% annual mass load reduction using retention will require between 0.25-0.75 inch of dry retention as pre-treatment. When pre-treatment is provided and the remaining stormwater is discharged into the wet detention pond, the overall treatment system will achieve a mass removal efficiency of 80% for total nitrogen. The mass removal efficiency for total phosphorus and other significant pollutants will be substantially in excess of 80%.

6.2 Design Criteria to Achieve 95% Removal

6.2.1 Dry Retention

An evaluation of required retention depths to achieve an annual removal efficiency of 95%, corresponding to the OFW criteria outlined in the Water Resource Implementation Rule (Chapter 62-40), was performed using the same methodology outlined previously for evaluation of retention criteria based upon an 80% annual mass load reduction. To achieve an annual mass load reduction of 95%, it is assumed that 95% of the annual runoff volume must be removed by the retention system. A summary of required retention depths to achieve an annual removal efficiency of 95% for each of the five zones is given in Table 6-4. Treatment depths necessary to achieve 95% annual pollutant mass removal range from 2.99-3.98 inches of retention over the project area, based upon location and variations in DCIA percentage and non-DCIA curve number.

Variations in required dry retention depth to achieve 95% removal on a state-wide average basis are illustrated on Figure 6-5. The lowest retention depths necessary to achieve 95% annual mass removal occur at low values for DCIA percentage and non-DCIA curve number. However, as DCIA percentages and non-DCIA curve numbers increase, retention treatment requirements also increase, approaching values ranging from 3.2-3.4 inches of retention. Similar to the trends observed with the analysis for 80% removal, a higher than average retention depth is necessary in the Panhandle and Florida Keys to achieve a 95% removal, while a lower than average retention depth would be necessary in Central areas.

6.2.2 Wet Detention

As indicated in previous sections, wet detention systems are not capable of providing a 95% pollutant removal efficiency for either total nitrogen or total phosphorus, even at extended detention periods. Therefore, to achieve the 95% removal objective for discharges to OFWs, a treatment train approach must be used with wet detention used in series with a high efficiency pre-treatment management technique.

To achieve an overall annual mass load reduction of 95% using wet detention, a pre-treatment system must be used to provide a significant portion of the desired pollutant removal efficiency. As an example, assumed that a wet detention pond is designed with a detention period of approximately 50 days which is sufficient to achieve a removal efficiency of approximately 40% for total nitrogen. Using the relationship summarized as Eq. 1, and assuming that the efficiency of the wet detention system for total nitrogen (40%) is represented by Eff_2 , the efficiency of the initial treatment system (Eff_1) would need to be 92% to achieve an overall treatment efficiency of 95%. When pre-treatment is provided and the remaining stormwater is discharged into the wet detention pond, the overall treatment system will achieve a mass removal efficiency of 95% for total nitrogen. However, the mass removal for total phosphorus and other significant pollutants will be in excess of 95%.

TABLE 6-4
REQUIRED RETENTION DEPTHS TO ACHIEVE AN
ANNUAL REMOVAL EFFICIENCY OF 95%

State-Wide Average

NDCIA CN	Percent DCIA																		
	10	15	20	25	30	35	40	45	50	55	60	65	70	75	80	85	90	95	100
30	0.70	0.77	0.90	1.04	1.19	1.35	1.51	1.67	1.84	2.00	2.16	2.33	2.49	2.66	2.82	2.98	3.13	3.27	3.40
35	0.88	0.91	1.01	1.13	1.27	1.42	1.57	1.72	1.88	2.04	2.20	2.36	2.52	2.68	2.84	2.99	3.14	3.27	3.40
40	1.11	1.08	1.15	1.25	1.37	1.50	1.64	1.79	1.94	2.09	2.24	2.40	2.55	2.70	2.86	3.01	3.15	3.28	3.40
45	1.37	1.29	1.32	1.39	1.49	1.61	1.73	1.87	2.01	2.15	2.29	2.44	2.59	2.73	2.88	3.02	3.15	3.28	3.40
50	1.65	1.53	1.52	1.56	1.64	1.74	1.85	1.96	2.09	2.22	2.35	2.49	2.63	2.77	2.91	3.04	3.16	3.28	3.40
55	1.92	1.78	1.74	1.76	1.81	1.89	1.98	2.08	2.19	2.31	2.43	2.55	2.68	2.81	2.94	3.06	3.18	3.29	3.40
60	2.19	2.04	1.98	1.98	2.00	2.06	2.13	2.21	2.31	2.41	2.51	2.63	2.74	2.86	2.97	3.08	3.19	3.30	3.40
65	2.46	2.30	2.23	2.20	2.21	2.25	2.30	2.36	2.44	2.52	2.61	2.71	2.81	2.91	3.01	3.11	3.21	3.31	3.40
70	2.70	2.56	2.48	2.44	2.44	2.45	2.48	2.53	2.59	2.66	2.73	2.81	2.89	2.98	3.06	3.15	3.23	3.32	3.40
75	2.93	2.81	2.73	2.68	2.66	2.67	2.68	2.71	2.75	2.80	2.86	2.92	2.98	3.05	3.12	3.19	3.26	3.33	3.40
80	3.12	3.03	2.97	2.92	2.89	2.88	2.88	2.90	2.92	2.95	2.99	3.03	3.08	3.12	3.18	3.23	3.29	3.34	3.40
85	3.27	3.21	3.16	3.13	3.10	3.08	3.08	3.08	3.09	3.10	3.12	3.15	3.18	3.21	3.24	3.28	3.32	3.36	3.40
90	3.39	3.35	3.32	3.30	3.28	3.26	3.25	3.25	3.25	3.25	3.26	3.27	3.28	3.29	3.31	3.33	3.35	3.37	3.40
95	3.46	3.44	3.43	3.41	3.40	3.39	3.39	3.38	3.38	3.38	3.37	3.37	3.37	3.38	3.38	3.38	3.39	3.39	3.40
98	3.44	3.44	3.43	3.43	3.42	3.42	3.42	3.42	3.41	3.41	3.41	3.41	3.40	3.40	3.40	3.40	3.40	3.40	3.40

TABLE 6-4 -- CONTINUED
REQUIRED RETENTION DEPTHS TO ACHIEVE AN
ANNUAL REMOVAL EFFICIENCY OF 95%

Panhandle (Zone 1)

NDCIA CN	Percent DCIA																		
	10	15	20	25	30	35	40	45	50	55	60	65	70	75	80	85	90	95	100
30	0.82	0.92	1.09	1.28	1.46	1.66	1.86	2.06	2.26	2.46	2.66	2.86	3.06	3.26	3.47	3.65	3.79	3.90	3.95
35	1.11	1.08	1.21	1.37	1.56	1.74	1.93	2.12	2.31	2.51	2.70	2.90	3.09	3.29	3.49	3.66	3.79	3.90	3.95
40	1.43	1.32	1.38	1.51	1.67	1.84	2.02	2.20	2.38	2.57	2.75	2.94	3.13	3.32	3.51	3.68	3.80	3.90	3.95
45	1.75	1.60	1.61	1.70	1.82	1.97	2.13	2.30	2.47	2.64	2.82	3.00	3.18	3.36	3.54	3.69	3.81	3.90	3.95
50	2.06	1.89	1.87	1.93	2.02	2.14	2.28	2.42	2.58	2.74	2.90	3.06	3.23	3.41	3.57	3.71	3.82	3.91	3.95
55	2.36	2.19	2.14	2.18	2.24	2.34	2.45	2.58	2.71	2.85	3.00	3.15	3.30	3.46	3.61	3.73	3.83	3.91	3.95
60	2.64	2.48	2.43	2.44	2.49	2.56	2.65	2.75	2.87	2.99	3.12	3.25	3.39	3.53	3.65	3.76	3.84	3.91	3.95
65	2.91	2.78	2.72	2.72	2.75	2.80	2.86	2.95	3.04	3.15	3.26	3.37	3.49	3.60	3.70	3.78	3.86	3.92	3.95
70	3.18	3.07	3.02	3.01	3.02	3.05	3.10	3.16	3.24	3.32	3.40	3.50	3.59	3.67	3.75	3.81	3.88	3.92	3.95
75	3.46	3.37	3.32	3.30	3.30	3.31	3.34	3.38	3.44	3.50	3.56	3.62	3.68	3.74	3.79	3.84	3.90	3.93	3.95
80	3.72	3.65	3.60	3.58	3.57	3.57	3.58	3.60	3.63	3.67	3.70	3.73	3.77	3.80	3.84	3.88	3.91	3.93	3.95
85	3.83	3.81	3.79	3.78	3.77	3.77	3.77	3.77	3.78	3.79	3.81	3.82	3.84	3.86	3.89	3.91	3.92	3.94	3.95
90	3.92	3.90	3.89	3.89	3.88	3.88	3.88	3.88	3.88	3.89	3.89	3.90	3.90	3.91	3.92	3.93	3.93	3.94	3.95
95	3.96	3.95	3.95	3.95	3.94	3.94	3.94	3.94	3.94	3.94	3.94	3.94	3.94	3.94	3.94	3.95	3.95	3.95	3.95
98	3.96	3.96	3.96	3.96	3.96	3.96	3.95	3.95	3.95	3.95	3.95	3.95	3.95	3.95	3.95	3.95	3.95	3.95	3.95

TABLE 6-4 -- CONTINUED
REQUIRED RETENTION DEPTHS TO ACHIEVE AN
ANNUAL REMOVAL EFFICIENCY OF 95%

Central (Zone 2)

NDCIA CN	Percent DCIA																		
	10	15	20	25	30	35	40	45	50	55	60	65	70	75	80	85	90	95	100
30	0.44	0.55	0.69	0.82	0.96	1.11	1.25	1.40	1.54	1.69	1.83	1.98	2.12	2.26	2.41	2.55	2.70	2.84	2.99
35	0.54	0.61	0.74	0.87	1.00	1.14	1.28	1.42	1.56	1.71	1.85	1.99	2.13	2.28	2.42	2.56	2.71	2.85	2.99
40	0.69	0.71	0.81	0.93	1.06	1.19	1.32	1.46	1.60	1.74	1.87	2.01	2.15	2.29	2.43	2.57	2.71	2.85	2.99
45	0.88	0.86	0.91	1.01	1.13	1.25	1.38	1.51	1.64	1.77	1.90	2.04	2.17	2.31	2.45	2.58	2.72	2.85	2.99
50	1.11	1.04	1.06	1.13	1.22	1.33	1.45	1.57	1.69	1.82	1.95	2.07	2.20	2.33	2.46	2.59	2.73	2.86	2.99
55	1.36	1.25	1.23	1.27	1.35	1.43	1.54	1.64	1.76	1.87	2.00	2.12	2.24	2.36	2.49	2.61	2.74	2.86	2.99
60	1.61	1.48	1.44	1.45	1.50	1.57	1.65	1.75	1.84	1.95	2.06	2.17	2.28	2.40	2.52	2.63	2.75	2.87	2.99
65	1.86	1.72	1.66	1.66	1.68	1.73	1.79	1.87	1.95	2.05	2.14	2.24	2.34	2.45	2.55	2.66	2.77	2.88	2.99
70	2.10	1.96	1.89	1.87	1.88	1.91	1.96	2.01	2.08	2.15	2.24	2.32	2.41	2.50	2.60	2.69	2.79	2.89	2.99
75	2.33	2.20	2.13	2.10	2.09	2.11	2.14	2.18	2.23	2.29	2.35	2.42	2.49	2.57	2.65	2.73	2.82	2.90	2.99
80	2.54	2.44	2.37	2.33	2.32	2.32	2.33	2.36	2.39	2.43	2.48	2.53	2.59	2.65	2.71	2.78	2.85	2.92	2.99
85	2.73	2.65	2.60	2.57	2.55	2.54	2.54	2.55	2.57	2.59	2.62	2.66	2.70	2.74	2.79	2.83	2.88	2.94	2.99
90	2.88	2.84	2.81	2.78	2.77	2.76	2.75	2.75	2.76	2.77	2.78	2.80	2.82	2.84	2.87	2.90	2.93	2.96	2.99
95	3.00	2.98	2.97	2.96	2.95	2.94	2.94	2.94	2.94	2.94	2.94	2.94	2.94	2.95	2.95	2.96	2.97	2.98	2.99
98	3.02	3.01	3.01	3.01	3.01	3.00	3.00	3.00	2.99	2.99	2.99	2.99	2.99	2.99	2.99	2.99	2.99	2.99	2.99

TABLE 6-4 -- CONTINUED
REQUIRED RETENTION DEPTHS TO ACHIEVE AN
ANNUAL REMOVAL EFFICIENCY OF 95%

Florida Keys (Zone 3)

NDCIA CN	Percent DCIA																		
	10	15	20	25	30	35	40	45	50	55	60	65	70	75	80	85	90	95	100
30	2.25	1.96	1.71	1.72	1.82	1.96	2.13	2.30	2.48	2.67	2.86	3.05	3.24	3.43	3.59	3.69	3.79	3.88	3.98
35	2.32	2.40	2.10	2.05	2.07	2.15	2.28	2.44	2.60	2.76	2.94	3.12	3.30	3.48	3.60	3.70	3.79	3.88	3.98
40	2.42	2.47	2.55	2.38	2.36	2.38	2.46	2.58	2.73	2.87	3.03	3.19	3.36	3.52	3.61	3.70	3.79	3.89	3.98
45	2.55	2.58	2.62	2.70	2.65	2.64	2.67	2.75	2.87	3.00	3.13	3.28	3.43	3.54	3.62	3.71	3.80	3.89	3.98
50	2.69	2.70	2.73	2.79	2.85	2.90	2.89	2.94	3.03	3.14	3.25	3.38	3.47	3.56	3.64	3.72	3.81	3.89	3.98
55	2.83	2.84	2.86	2.89	2.95	3.00	3.07	3.14	3.21	3.28	3.35	3.43	3.50	3.58	3.66	3.74	3.82	3.90	3.98
60	2.98	2.98	2.99	3.01	3.06	3.10	3.15	3.21	3.28	3.34	3.41	3.47	3.54	3.61	3.68	3.75	3.83	3.90	3.98
65	3.13	3.13	3.12	3.14	3.17	3.21	3.25	3.30	3.35	3.41	3.47	3.52	3.59	3.65	3.71	3.78	3.84	3.91	3.98
70	3.29	3.28	3.26	3.28	3.30	3.33	3.36	3.40	3.44	3.49	3.54	3.59	3.64	3.69	3.74	3.80	3.86	3.92	3.98
75	3.44	3.42	3.41	3.42	3.44	3.45	3.47	3.50	3.54	3.58	3.61	3.65	3.69	3.74	3.78	3.83	3.88	3.93	3.98
80	3.59	3.57	3.57	3.57	3.58	3.59	3.60	3.62	3.65	3.67	3.70	3.73	3.76	3.79	3.82	3.86	3.90	3.94	3.98
85	3.75	3.74	3.73	3.73	3.72	3.72	3.73	3.74	3.76	3.77	3.79	3.81	3.83	3.85	3.87	3.89	3.92	3.95	3.98
90	3.91	3.89	3.88	3.87	3.87	3.87	3.87	3.87	3.87	3.88	3.88	3.89	3.90	3.91	3.92	3.93	3.95	3.96	3.98
95	3.99	3.99	3.99	3.99	4.00	3.99	3.98	3.98	3.98	3.97	3.97	3.97	3.97	3.97	3.97	3.97	3.97	3.97	3.98
98	4.00	4.00	4.00	4.00	4.00	4.00	4.00	4.00	4.00	3.99	3.99	3.99	3.99	3.99	3.98	3.98	3.98	3.98	3.98

TABLE 6-4 -- CONTINUED
REQUIRED RETENTION DEPTHS TO ACHIEVE AN
ANNUAL REMOVAL EFFICIENCY OF 95%

Coastal (Zone 4)

NDCIA CN	Percent DCIA																		
	10	15	20	25	30	35	40	45	50	55	60	65	70	75	80	85	90	95	100
30	0.62	0.73	0.85	1.00	1.15	1.31	1.47	1.63	1.79	1.95	2.11	2.28	2.44	2.60	2.76	2.93	3.09	3.25	3.41
35	0.83	0.85	0.96	1.09	1.23	1.37	1.52	1.68	1.83	1.99	2.15	2.30	2.46	2.62	2.78	2.94	3.10	3.26	3.41
40	1.09	1.04	1.10	1.21	1.32	1.46	1.60	1.74	1.89	2.04	2.19	2.34	2.49	2.65	2.80	2.95	3.11	3.26	3.41
45	1.38	1.27	1.28	1.35	1.45	1.56	1.69	1.82	1.95	2.10	2.24	2.38	2.53	2.68	2.82	2.97	3.12	3.27	3.41
50	1.68	1.53	1.50	1.53	1.60	1.70	1.80	1.91	2.04	2.17	2.30	2.43	2.57	2.71	2.85	2.99	3.13	3.27	3.41
55	1.98	1.81	1.75	1.74	1.79	1.86	1.94	2.04	2.14	2.25	2.37	2.50	2.62	2.75	2.88	3.01	3.15	3.28	3.41
60	2.27	2.08	2.00	1.98	1.99	2.04	2.10	2.18	2.26	2.36	2.46	2.57	2.69	2.80	2.92	3.04	3.17	3.29	3.41
65	2.55	2.36	2.26	2.22	2.21	2.23	2.28	2.34	2.40	2.48	2.57	2.66	2.76	2.86	2.97	3.08	3.19	3.30	3.41
70	2.82	2.63	2.52	2.47	2.45	2.45	2.47	2.51	2.56	2.62	2.69	2.76	2.85	2.93	3.02	3.12	3.22	3.31	3.41
75	3.06	2.89	2.79	2.72	2.68	2.67	2.68	2.70	2.73	2.77	2.82	2.88	2.94	3.01	3.09	3.16	3.25	3.33	3.41
80	3.25	3.13	3.04	2.97	2.92	2.90	2.89	2.89	2.91	2.93	2.96	3.00	3.05	3.10	3.16	3.22	3.28	3.35	3.41
85	3.42	3.32	3.25	3.20	3.15	3.12	3.10	3.09	3.09	3.10	3.11	3.14	3.16	3.20	3.24	3.28	3.32	3.37	3.41
90	3.53	3.47	3.42	3.38	3.35	3.32	3.29	3.28	3.27	3.26	3.27	3.27	3.29	3.30	3.32	3.34	3.36	3.39	3.41
95	3.56	3.53	3.51	3.49	3.47	3.45	3.44	3.43	3.42	3.41	3.40	3.40	3.40	3.40	3.40	3.40	3.40	3.41	3.41
98	3.49	3.48	3.48	3.47	3.46	3.46	3.45	3.45	3.44	3.44	3.43	3.43	3.43	3.42	3.42	3.42	3.42	3.42	3.41

TABLE 6-4 -- CONTINUED
REQUIRED RETENTION DEPTHS TO ACHIEVE AN
ANNUAL REMOVAL EFFICIENCY OF 95%

Southeast Coastal (Zone 5)

NDCIA CN	Percent DCIA																		
	10	15	20	25	30	35	40	45	50	55	60	65	70	75	80	85	90	95	100
30	1.05	1.08	1.19	1.34	1.51	1.68	1.86	2.04	2.22	2.41	2.59	2.78	2.97	3.15	3.34	3.52	3.69	3.80	3.91
35	1.43	1.37	1.42	1.52	1.65	1.81	1.97	2.14	2.31	2.49	2.66	2.83	3.01	3.19	3.37	3.55	3.70	3.80	3.91
40	1.82	1.71	1.70	1.75	1.84	1.96	2.11	2.26	2.41	2.57	2.74	2.90	3.07	3.24	3.40	3.57	3.71	3.81	3.91
45	2.22	2.05	2.01	2.01	2.07	2.15	2.27	2.39	2.53	2.68	2.82	2.98	3.13	3.29	3.44	3.60	3.72	3.81	3.91
50	2.59	2.40	2.32	2.30	2.32	2.37	2.45	2.55	2.67	2.79	2.93	3.06	3.20	3.34	3.49	3.63	3.74	3.82	3.91
55	2.95	2.74	2.64	2.59	2.58	2.60	2.65	2.73	2.82	2.93	3.04	3.16	3.28	3.41	3.54	3.65	3.75	3.83	3.91
60	3.28	3.07	2.95	2.88	2.85	2.85	2.87	2.92	2.99	3.07	3.17	3.27	3.37	3.49	3.59	3.69	3.76	3.84	3.91
65	3.58	3.38	3.25	3.16	3.11	3.09	3.09	3.12	3.16	3.23	3.30	3.39	3.47	3.56	3.64	3.72	3.78	3.84	3.91
70	3.77	3.66	3.53	3.44	3.37	3.33	3.31	3.32	3.35	3.39	3.45	3.51	3.57	3.63	3.70	3.75	3.80	3.85	3.91
75	3.92	3.86	3.75	3.66	3.59	3.55	3.52	3.52	3.53	3.55	3.58	3.62	3.66	3.71	3.75	3.78	3.82	3.86	3.91
80	3.97	3.95	3.92	3.85	3.78	3.72	3.69	3.68	3.68	3.69	3.70	3.73	3.75	3.77	3.79	3.82	3.84	3.88	3.91
85	4.00	3.98	3.97	3.95	3.89	3.86	3.84	3.82	3.81	3.81	3.81	3.81	3.82	3.83	3.84	3.85	3.87	3.89	3.91
90	4.00	4.00	4.00	3.99	3.97	3.95	3.93	3.92	3.91	3.90	3.89	3.89	3.89	3.88	3.88	3.89	3.89	3.90	3.91
95	4.00	4.00	3.99	3.99	3.98	3.97	3.97	3.96	3.95	3.95	3.94	3.93	3.93	3.92	3.92	3.92	3.91	3.91	3.91
98	3.97	3.96	3.96	3.96	3.95	3.95	3.95	3.94	3.94	3.93	3.93	3.93	3.93	3.92	3.92	3.92	3.91	3.91	3.91

Statewide Mean Retention Depth Needed to Achieve 95% Annual Mass Removal

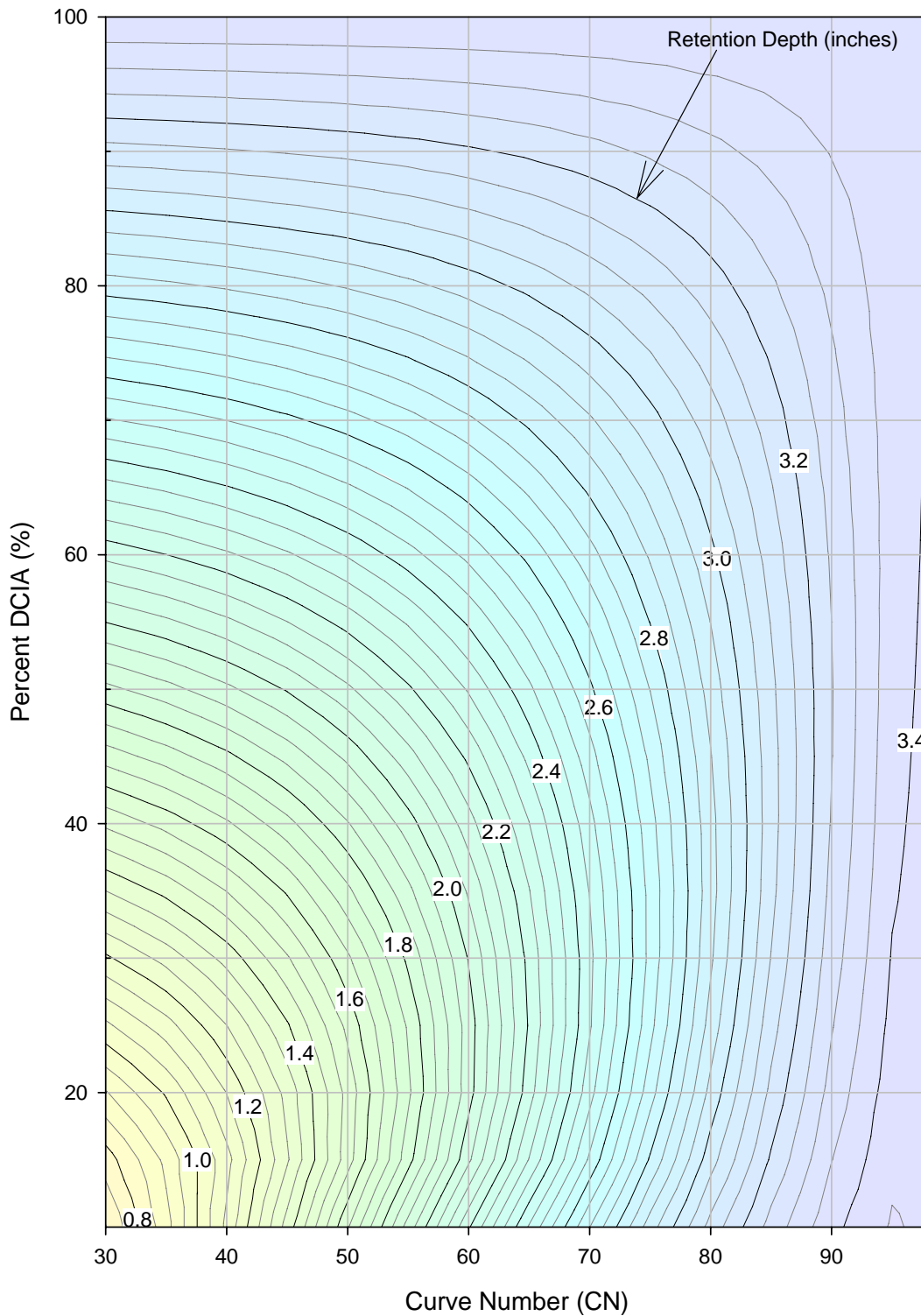

Figure 6-5. Variations in Required Dry Retention Depth to Achieve 95% Removal on a State-wide Basis.

6.3 Design Criteria to Achieve Post-Development Less Than or Equal to Pre-Development Loadings

An analysis was also performed to provide estimates of the annual mass pollutant removal efficiencies necessary to achieve no net increase in pollutant loadings following development compared with loadings which discharge from the site under pre-development conditions. This analysis is conducted primarily for nitrogen and phosphorus, since systems which achieve post \leq pre pollutant loadings for nitrogen and phosphorus will automatically provide this condition for TSS, BOD, and other significant runoff pollutants.

6.3.1 Estimation of Pre-Development Pollutant Loadings

This analysis assumes that the undeveloped condition consists of brush (brush-weed-grass mixture), woods, or a mixture of the two. A summary of hydrologic assumptions for this pre-development condition is given in Table 6-5. For estimation of annual runoff volumes, the hydrologic condition is assumed to be fair, with 50-75% ground cover and litter covering much of the soil. SCS curve numbers for use in hydrologic modeling are assumed for hydrologic soil groups (HSG) A, B, C, and D using the average curve numbers for brush and wooded areas provided in the TR-55 publication.

TABLE 6-5

HYDROLOGIC ASSUMPTIONS FOR ESTIMATION OF RUNOFF AND MASS LOADINGS FROM UNDEVELOPED AREAS

PARAMETER	ASSUMED CONDITION / VALUE
Land Use	Brush / woods
Hydrologic Condition	Fair: 50-75% ground cover, woods not burned, forest litter covers the soil
Curve Number ¹	HSG A: 35.5 HSG B: 58 HSG C: 71.5 HSG D: 78

1. Average of brush and woods categories

Calculated annual C values for undeveloped/natural areas are summarized in Table 6-6 for each of the regional meteorological zones. These values are calculated using the continuous simulation technique discussed in Section 4.2 and the hydrologic characteristics listed in Table 6-5. The mean values summarized at the bottom of Table 6-6 reflect the state-wide mean rather than the arithmetic mean of the values for each zone. In general, approximately 1.5% or less of the annual rainfall which occurs on undeveloped/natural areas under HSG A conditions becomes stormwater runoff. Under HSG B conditions, this percentage increases to approximately 4-7%, with 9-13% under HSG C conditions and 13-18% under HSG D conditions.

TABLE 6-6
ANNUAL C VALUES FOR
UNDEVELOPED / NATURAL AREAS

METEOROLOGICAL L ZONE	ANNUAL C VALUE			
	HSG A	HSG B	HSG C	HSG D
1	0.015	0.064	0.126	0.176
2	0.006	0.038	0.087	0.128
3	0.015	0.053	0.103	0.142
4	0.010	0.050	0.104	0.149
5	0.018	0.067	0.127	0.173
Mean¹	0.011	0.049	0.103	0.147

1. Reflects state-wide average value

Estimates of annual runoff depths for undeveloped/natural areas were calculated using the methodology outlined in Section 4.2.1 for each of the five meteorological zones and four hydrologic soil groups. A summary of calculated runoff depths for undeveloped/natural areas is given in Table 6-7 for each of the five meteorological zones. The runoff depth presented for each zone is calculated by multiplying the annual C value for each hydrologic soil group (summarized in Table 6-6) times the mean annual rainfall for each zone. The values summarized in Table 6-7 reflect estimates of the long-term mean annual runoff depth for undeveloped/natural areas in each of the five zones based upon available rainfall data. A relatively high degree of variability is apparent in calculated annual runoff depths for undeveloped/natural areas in each of the five zones. The degree of variability appears to be greatest for soils in HSG A, with decreases in variability observed for less permeable soil types.

TABLE 6-7
CALCULATED ANNUAL RUNOFF DEPTHS
FOR UNDEVELOPED / NATURAL AREAS

METEOROLOGICAL L ZONE	ANNUAL RUNOFF DEPTH (inches)				MEAN RAINFAL L (in/yr)
	HSG A	HSG B	HSG C	HSG D	
1	0.91	3.90	7.68	10.73	60.96
2	0.30	1.89	4.33	6.36	49.72
3	0.65	2.30	4.47	6.16	43.41
4	0.52	2.62	5.45	7.81	52.42
5	1.05	3.90	7.39	10.06	58.17
Mean	0.69	2.92	5.86	8.23	52.94

Estimates of annual mass loadings of nitrogen and phosphorus discharging from undeveloped/natural areas were generated for each of the hydrologic soil groups and meteorological zones included in Tables 6-6 and 6-7. The annual runoff volume generated by each combination of meteorological zone and hydrologic soil group was calculated, assuming a theoretical area of 1 acre, using the annual runoff coefficients summarized in Table 6-6 and the annual rainfall depth represented by each meteorological site. The estimated annual runoff volumes were then multiplied by the assumed runoff characteristics for undeveloped/natural areas summarized in Table 4-17. For purposes of this analysis, total nitrogen concentrations in runoff discharging from undeveloped/natural areas is assumed to be 1.15 mg/l, with a total phosphorus concentration of 0.055 mg/l.

Estimates of the annual mass loadings of nitrogen and phosphorus generated by stormwater runoff in undeveloped/natural areas are summarized in Table 6-8. Annual mass loads are calculated for each hydrologic soil group and meteorological zone in terms of kg/acre-year for both total nitrogen and total phosphorus. The values summarized in this table represent the pre-development loadings generated by undeveloped/natural areas for each hydrologic soil group and meteorological zone. To achieve the goal of no net increase in loadings following development, discharges of total nitrogen and total phosphorus from the land parcel following development cannot exceed the pre-development values listed in Table 6-8.

TABLE 6-8

**ESTIMATED ANNUAL MASS LOADINGS OF NITROGEN
AND PHOSPHORUS FOR UNDEVELOPED / NATURAL AREAS**

METEOROLOGICAL ZONE	ANNUAL TN MASS LOAD (kg/ac-yr)				ANNUAL TP MASS LOAD (kg/ac-yr)			
	HSG A	HSG B	HSG C	HSG D	HSG A	HSG B	HSG C	HSG D
1	0.11	0.46	0.91	1.27	0.005	0.022	0.043	0.061
2	0.04	0.22	0.51	0.75	0.002	0.011	0.024	0.036
3	0.08	0.27	0.53	0.73	0.004	0.013	0.025	0.035
4	0.06	0.31	0.64	0.92	0.003	0.015	0.031	0.044
5	0.12	0.46	0.87	1.19	0.006	0.022	0.042	0.057
Mean	0.08	0.35	0.69	0.97	0.004	0.017	0.033	0.046

6.3.2 Estimation of Post-Development Pollutant Loadings

When a stormwater management system is designed to provide sufficient treatment so that the post-development loadings from a parcel are equal to or less than the pre-development loadings from the parcel, the post-development loadings would be calculated based upon the specific hydrologic and land use characteristics of the site, combined with the anticipated pollutant removal effectiveness of the proposed stormwater treatment option. However, for purposes of this analysis and to provide estimates of the magnitude of pollutant removal efficiencies necessary to achieve no net increase in pollutant loadings following development, calculations of estimated annual mass loadings for nitrogen and phosphorus were performed for “typical” residential and commercial developments, including low-density residential, single-family residential, high-density residential, and commercial land use categories.

A summary of hydrologic assumptions used for the developed land use categories is given in Table 6-9. The low-density residential areas are assumed to have approximately 15% impervious area, with 5% of the area as DCIA. Hydrologic characteristics are provided for single-family residential developments based on 25% impervious and 40% impervious conditions. High-density residential areas are assumed to be 65% impervious, with 80% impervious assumed for commercial activities. Highway land use categories are also included, based upon 50% and 75% impervious assumptions. Curve numbers for pervious areas are based on soil types and assumptions regarding landscaped conditions.

TABLE 6-9
SUMMARY OF HYDROLOGIC ASSUMPTIONS
USED FOR DEVELOPED LAND USE CATEGORIES

TYPICAL LAND USE	PERCENT TOTAL IMPERVIOUS AREA	% DCIA ¹	CURVE NUMBER (CN) FOR PERVIOUS AREAS			
			HSG A	HSG B	HSG C	HSG D
Low-Density Residential	15	5	49 ²	69 ²	79 ²	84 ²
Single-Family Residential						
a. 25% impervious	25	15	39 ³	61 ³	74 ³	80 ³
b. 40% impervious	40	25	39 ³	61 ³	74 ³	80 ³
High-Density Residential	65	50	39 ³	61 ³	74 ³	80 ³
Commercial	80	75	39 ³	61 ³	74 ³	80 ³
Highway ⁴						
a. 50% impervious	50	50	49 ²	69 ²	79 ²	84 ²
b. 75% impervious	75	75	49 ²	69 ²	79 ²	84 ²

1. Percentage of total project area
2. Assumes open space, lawns, or landscaping in fair condition
3. Assumes open space, lawns, or landscaping in good condition
4. Includes area within right-of-way

Estimates of the annual runoff coefficients for each of the developed land use categories were generated using the methodology outlined in Section 4.2.1 and the hydrologic characteristics summarized in Table 6-9. Separate calculations were performed for each of the five meteorological zones and four hydrologic soil groups for each identified land use category. Separate calculations were performed for each of the hourly meteorological monitoring sites contained within each of the five zones, and the mean runoff coefficient was calculated for each combination of development category, soil type, and zone. A summary of calculated annual runoff coefficients for typical developed land use categories is given in Table 6-10. The values summarized in Table 6-10 reflect long-term average runoff coefficients based upon the available period of record for hourly meteorological sites within each of the five zones. In general, estimated annual runoff coefficients increase with changes in hydrologic soil group and increases in land use intensity.

TABLE 6-10

**SUMMARY OF CALCULATED ANNUAL RUNOFF
COEFFICIENTS FOR TYPICAL DEVELOPED LAND USE CATEGORIES**

METEOROLOGICAL ZONE	LOW-DENSITY RESIDENTIAL AREAS				SINGLE-FAMILY RESIDENTIAL AREAS (25% Impervious)			
	ANNUAL C VALUE				ANNUAL C VALUE			
	HSG A	HSG B	HSG C	HSG D	HSG A	HSG B	HSG C	HSG D
1	0.092	0.166	0.238	0.294	0.155	0.206	0.268	0.313
2	0.069	0.126	0.187	0.237	0.136	0.173	0.223	0.262
3	0.084	0.141	0.198	0.243	0.145	0.186	0.233	0.269
4	0.080	0.143	0.209	0.232	0.144	0.187	0.242	0.283
5	0.093	0.164	0.232	0.284	0.151	0.202	0.260	0.302
Mean	0.084	0.148	0.213	0.258	0.146	0.191	0.245	0.286

METEOROLOGICAL ZONE	SINGLE-FAMILY RESIDENTIAL AREAS (40% Impervious)				MULTI-FAMILY RESIDENTIAL			
	ANNUAL C VALUE				ANNUAL C VALUE			
	HSG A	HSG B	HSG C	HSG D	HSG A	HSG B	HSG C	HSG D
1	0.245	0.294	0.350	0.391	0.455	0.490	0.529	0.556
2	0.220	0.257	0.303	0.339	0.423	0.450	0.483	0.508
3	0.228	0.266	0.310	0.343	0.424	0.451	0.482	0.504
4	0.231	0.272	0.322	0.360	0.435	0.465	0.501	0.527
5	0.237	0.284	0.337	0.375	0.435	0.469	0.506	0.531
Mean	0.232	0.275	0.324	0.362	0.434	0.465	0.500	0.525

METEOROLOGICAL ZONE	COMMERCIAL AREAS				HIGHWAY AREAS (50% Impervious)			
	ANNUAL C VALUE				ANNUAL C VALUE			
	HSG A	HSG B	HSG C	HSG D	HSG A	HSG B	HSG C	HSG D
1	0.648	0.664	0.683	0.697	0.444	0.481	0.517	0.546
2	0.613	0.625	0.641	0.653	0.415	0.442	0.473	0.498
3	0.606	0.619	0.633	0.644	0.415	0.444	0.472	0.496
4	0.626	0.639	0.656	0.669	0.426	0.457	0.490	0.517
5	0.618	0.633	0.651	0.664	0.425	0.460	0.495	0.522
Mean	0.622	0.636	0.653	0.665	0.425	0.457	0.489	0.516

METEOROLOGICAL ZONE	HIGHWAY AREAS (75% Impervious)			
	ANNUAL C VALUE			
	HSG A	HSG B	HSG C	HSG D
1	0.647	0.665	0.683	0.698
2	0.612	0.626	0.641	0.654
3	0.605	0.619	0.634	0.645
4	0.625	0.640	0.657	0.670
5	0.616	0.634	0.651	0.665
Mean	0.621	0.637	0.653	0.666

Estimates of annual runoff depths for typical developed land use categories and hydrologic soil groups are summarized in Table 6-11. These values are calculated by multiplying the annual runoff coefficients (summarized in Table 6-10) by the annual average rainfall for each of the designated meteorological zones.

Estimates of annual mass loadings of total nitrogen and total phosphorus for typical land use categories were calculated by multiplying the estimated annual runoff volume generated by each developed land use category and soil type times the recommended runoff characterization data for total nitrogen and total phosphorus summarized in Table 4-17. Annual runoff volumes were estimated for a theoretical 1 acre parcel by multiplying the annual runoff coefficients (summarized in Table 6-10) times the mean annual rainfall for each meteorological zone. This value was then multiplied by the typical concentrations summarized in Table 4-17 for total nitrogen and total phosphorus to obtain estimates of annual mass loadings for a wide variety of developed land use categories and hydrologic soil group types.

Calculated annual total nitrogen loadings for typical land use categories are summarized in Table 6-12. The values summarized in these tables reflect the estimated annual total nitrogen load discharging from each evaluated land use category and soil group type. In general, total nitrogen loadings increase as the intensity of development increases and soil permeability decreases. Calculated annual total phosphorus loadings for typical land use categories are summarized in Table 6-13. The values summarized in this table are calculated in the same manner as that previously described for total nitrogen. In general, estimated annual total phosphorus loadings also increase as the intensity of land development increases and soil permeability decreases.

6.3.3 Estimated Annual Removal Efficiencies

Required annual removal efficiencies were calculated to reduce the estimated annual loadings of total nitrogen (summarized in Table 6-12) and total phosphorus (summarized in Table 6-13) to values equal to or less than the estimated annual mass loadings of nitrogen and phosphorus for undeveloped/natural areas summarized in Table 6-8. This analysis was conducted for each evaluated land use category, soil type, and meteorological zone.

A summary of required removal efficiencies to achieve post-development \leq pre-development loadings for total nitrogen is given in Table 6-14. In general, required removal efficiencies for total nitrogen range from approximately 54-99%, depending upon the particular combination of land use category and soil type. The largest required removal efficiencies are required for multi-family and commercial areas.

Required removal efficiencies to achieve post-development \leq pre-development loadings for total phosphorus are summarized in Table 6-15. Required removals for total phosphorus range from approximately 82-99%, depending upon the specific combination of land use type, hydrologic soil group, and meteorological location.

TABLE 6-11

**SUMMARY OF ANNUAL RUNOFF DEPTHS
FOR TYPICAL DEVELOPED LAND USE CATEGORIES**

METEOROLOGICAL ZONE	LOW-DENSITY RESIDENTIAL AREAS				SINGLE-FAMILY RESIDENTIAL AREAS (25% Impervious)			
	ANNUAL RUNOFF DEPTH (inches)				ANNUAL RUNOFF DEPTH (inches)			
	HSG A	HSG B	HSG C	HSG D	HSG A	HSG B	HSG C	HSG D
1	5.61	10.12	14.51	17.92	9.45	12.56	16.34	19.08
2	3.43	6.26	9.30	11.78	6.76	8.60	11.09	13.03
3	3.65	6.12	8.60	10.55	6.29	8.07	10.11	11.68
4	4.19	7.50	10.96	12.16	7.55	9.80	12.69	14.83
5	5.41	9.54	13.50	16.52	8.78	11.75	15.12	17.57
Mean	4.46	7.91	11.37	13.79	7.77	10.16	13.07	15.24

METEOROLOGICAL ZONE	SINGLE-FAMILY RESIDENTIAL AREAS (40% Impervious)				MULTI-FAMILY RESIDENTIAL			
	ANNUAL RUNOFF DEPTH (inches)				ANNUAL RUNOFF DEPTH (inches)			
	HSG A	HSG B	HSG C	HSG D	HSG A	HSG B	HSG C	HSG D
1	14.94	17.92	21.34	23.84	27.74	29.87	32.25	33.89
2	10.94	12.78	15.07	16.86	21.03	22.37	24.01	25.26
3	9.90	11.55	13.46	14.89	18.41	19.58	20.92	21.88
4	12.11	14.26	16.88	18.87	22.80	24.38	26.26	27.63
5	13.79	16.52	19.60	21.81	25.30	27.28	29.43	30.89
Mean	12.33	14.61	17.27	19.25	23.06	24.70	26.58	27.91

METEOROLOGICAL ZONE	COMMERCIAL AREAS				HIGHWAY AREAS (50% Impervious)			
	ANNUAL RUNOFF DEPTH (inches)				ANNUAL RUNOFF DEPTH (inches)			
	HSG A	HSG B	HSG C	HSG D	HSG A	HSG B	HSG C	HSG D
1	39.50	40.48	41.64	42.49	27.07	29.32	31.52	33.28
2	30.48	31.08	31.87	32.47	20.63	21.98	23.52	24.76
3	26.31	26.87	27.48	27.96	18.02	19.27	20.49	21.53
4	32.81	33.50	34.39	35.07	22.33	23.96	25.69	27.10
5	35.95	36.82	37.87	38.62	24.72	26.76	28.79	30.36
Mean	33.01	33.75	34.65	35.32	22.55	24.26	26.00	27.41

METEOROLOGICAL ZONE	HIGHWAY AREAS (75% Impervious)			
	ANNUAL RUNOFF DEPTH (inches)			
	HSG A	HSG B	HSG C	HSG D
1	39.44	40.54	41.64	42.55
2	30.43	31.12	31.87	32.52
3	26.26	26.87	27.52	28.00
4	32.76	33.55	34.44	35.12
5	35.83	36.88	37.87	38.68
Mean	32.95	33.79	34.67	35.37

TABLE 6-12

**CALCULATED TOTAL NITROGEN LOADINGS
FOR TYPICAL DEVELOPED LAND USE CATEGORIES**

METEOROLOGICAL ZONE	LOW-DENSITY RESIDENTIAL AREAS				SINGLE-FAMILY RESIDENTIAL AREAS (25% Impervious)			
	ANNUAL TN MASS LOAD (kg/ac-yr)				ANNUAL TN MASS LOAD (kg/ac-yr)			
	HSG A	HSG B	HSG C	HSG D	HSG A	HSG B	HSG C	HSG D
1	0.93	1.67	2.40	2.97	2.01	2.67	3.48	4.06
2	0.57	1.04	1.54	1.95	1.44	1.83	2.36	2.77
3	0.60	1.01	1.42	1.75	1.34	1.72	2.15	2.48
4	0.69	1.24	1.81	2.01	1.61	2.09	2.70	3.16
5	0.90	1.58	2.23	2.73	1.87	2.50	3.22	3.74
Mean	0.74	1.31	1.88	2.28	1.65	2.16	2.78	3.24

METEOROLOGICAL ZONE	SINGLE-FAMILY RESIDENTIAL AREAS (40% Impervious)				MULTI-FAMILY RESIDENTIAL			
	ANNUAL TN MASS LOAD (kg/ac-yr)				ANNUAL TN MASS LOAD (kg/ac-yr)			
	HSG A	HSG B	HSG C	HSG D	HSG A	HSG B	HSG C	HSG D
1	3.18	3.81	4.54	5.07	6.61	7.12	7.69	8.08
2	2.33	2.72	3.20	3.59	5.01	5.33	5.73	6.02
3	2.11	2.46	2.86	3.17	4.39	4.67	4.99	5.22
4	2.58	3.03	3.59	4.01	5.44	5.81	6.26	6.59
5	2.93	3.51	4.17	4.64	6.03	6.50	7.02	7.36
Mean	2.62	3.11	3.67	4.10	5.50	5.89	6.34	6.65

METEOROLOGICAL ZONE	COMMERCIAL AREAS				HIGHWAY AREAS (50% Impervious)			
	ANNUAL TN MASS LOAD (kg/ac-yr)				ANNUAL TN MASS LOAD (kg/ac-yr)			
	HSG A	HSG B	HSG C	HSG D	HSG A	HSG B	HSG C	HSG D
1	9.74	9.98	10.27	10.48	4.56	4.94	5.31	5.61
2	7.52	7.66	7.86	8.01	3.48	3.70	3.96	4.17
3	6.49	6.63	6.78	6.90	3.04	3.25	3.45	3.63
4	8.09	8.26	8.48	8.65	3.76	4.04	4.33	4.57
5	8.87	9.08	9.34	9.53	4.17	4.51	4.85	5.12
Mean	8.14	8.32	8.55	8.71	3.80	4.09	4.38	4.62

METEOROLOGICAL ZONE	HIGHWAY AREAS (75% Impervious)			
	ANNUAL TN MASS LOAD (kg/ac-yr)			
	HSG A	HSG B	HSG C	HSG D
1	6.65	6.83	7.02	7.17
2	5.13	5.25	5.37	5.48
3	4.43	4.53	4.64	4.72
4	5.52	5.65	5.80	5.92
5	6.04	6.22	6.38	6.52
Mean	5.55	5.70	5.84	5.96

TABLE 6-13

**CALCULATED TOTAL PHOSPHORUS LOADINGS
FOR TYPICAL DEVELOPED LAND USE CATEGORIES**

METEOROLOGICAL ZONE	LOW-DENSITY RESIDENTIAL AREAS				SINGLE-FAMILY RESIDENTIAL AREAS (25% Impervious)			
	ANNUAL TP MASS LOAD (kg/ac-yr)				ANNUAL TP MASS LOAD (kg/ac-yr)			
	HSG A	HSG B	HSG C	HSG D	HSG A	HSG B	HSG C	HSG D
1	0.110	0.199	0.285	0.352	0.318	0.422	0.549	0.641
2	0.067	0.123	0.183	0.231	0.227	0.289	0.373	0.438
3	0.072	0.120	0.169	0.207	0.212	0.271	0.340	0.392
4	0.082	0.147	0.215	0.239	0.254	0.329	0.426	0.499
5	0.106	0.187	0.265	0.324	0.295	0.395	0.508	0.590
Mean	0.088	0.155	0.223	0.271	0.261	0.341	0.439	0.512

METEOROLOGICAL ZONE	SINGLE-FAMILY RESIDENTIAL AREAS (40% Impervious)				MULTI-FAMILY RESIDENTIAL			
	ANNUAL TP MASS LOAD (kg/ac-yr)				ANNUAL TP MASS LOAD (kg/ac-yr)			
	HSG A	HSG B	HSG C	HSG D	HSG A	HSG B	HSG C	HSG D
1	0.502	0.602	0.717	0.801	1.482	1.596	1.723	1.811
2	0.368	0.429	0.506	0.566	1.124	1.196	1.283	1.350
3	0.333	0.388	0.452	0.500	0.984	1.046	1.118	1.169
4	0.407	0.479	0.567	0.634	1.219	1.303	1.403	1.476
5	0.463	0.555	0.659	0.733	1.352	1.458	1.573	1.651
Mean	0.414	0.491	0.580	0.647	1.232	1.320	1.420	1.491

METEOROLOGICAL ZONE	COMMERCIAL AREAS				HIGHWAY AREAS (50% Impervious)			
	ANNUAL TP MASS LOAD (kg/ac-yr)				ANNUAL TP MASS LOAD (kg/ac-yr)			
	HSG A	HSG B	HSG C	HSG D	HSG A	HSG B	HSG C	HSG D
1	1.401	1.435	1.476	1.507	0.612	0.663	0.713	0.753
2	1.081	1.102	1.130	1.151	0.467	0.497	0.532	0.560
3	0.933	0.953	0.974	0.991	0.407	0.436	0.463	0.487
4	1.163	1.188	1.219	1.243	0.505	0.542	0.581	0.613
5	1.275	1.306	1.343	1.369	0.559	0.605	0.651	0.687
Mean	1.170	1.197	1.228	1.252	0.510	0.548	0.588	0.620

METEOROLOGICAL ZONE	HIGHWAY AREAS (75% Impervious)			
	ANNUAL TP MASS LOAD (kg/ac-yr)			
	HSG A	HSG B	HSG C	HSG D
1	0.892	0.917	0.941	0.962
2	0.688	0.704	0.721	0.735
3	0.594	0.608	0.622	0.633
4	0.741	0.759	0.779	0.794
5	0.810	0.834	0.856	0.875
Mean	0.745	0.764	0.784	0.800

TABLE 6-14

**REQUIRED REMOVAL EFFICIENCIES TO ACHIEVE
POST-DEVELOPMENT LESS THAN OR EQUAL TO
PRE-DEVELOPMENT LOADINGS FOR TOTAL NITROGEN**

METEOROLOGICAL ZONE	LOW-DENSITY RESIDENTIAL AREAS				SINGLE-FAMILY RESIDENTIAL AREAS (25% Impervious)			
	Required Removal Efficiency (%)				Required Removal Efficiency (%)			
	HSG A	HSG B	HSG C	HSG D	HSG A	HSG B	HSG C	HSG D
1	88.4	72.5	62.2	57.2	94.6	82.7	73.9	68.8
2	93.8	78.5	66.8	61.4	97.5	87.8	78.3	72.9
3	87.2	73.2	62.8	58.3	94.3	84.2	75.4	70.7
4	91.1	75.0	64.5	54.1	96.1	85.1	76.1	70.7
5	86.2	70.8	60.9	56.5	93.4	81.6	72.9	68.2
Mean	89.3	74.0	63.4	57.5	95.2	84.3	75.3	70.2

METEOROLOGICAL ZONE	SINGLE-FAMILY RESIDENTIAL AREAS (40% Impervious)				MULTI-FAMILY RESIDENTIAL			
	Required Removal Efficiency (%)				Required Removal Efficiency (%)			
	HSG A	HSG B	HSG C	HSG D	HSG A	HSG B	HSG C	HSG D
1	96.6	87.9	80.0	75.0	98.4	93.5	88.2	84.3
2	98.5	91.8	84.0	79.0	99.3	95.8	91.1	87.5
3	96.3	88.9	81.5	77.0	98.2	94.2	89.4	86.0
4	97.6	89.8	82.1	77.0	98.9	94.7	89.7	86.0
5	95.8	86.9	79.1	74.4	97.9	92.9	87.6	83.9
Mean	97.0	89.1	81.3	76.5	98.5	94.2	89.2	85.5

METEOROLOGICAL ZONE	COMMERCIAL AREAS				HIGHWAY AREAS (50% Impervious)			
	Required Removal Efficiency (%)				Required Removal Efficiency (%)			
	HSG A	HSG B	HSG C	HSG D	HSG A	HSG B	HSG C	HSG D
1	98.9	95.4	91.2	87.9	97.6	90.7	82.9	77.4
2	99.5	97.1	93.5	90.6	99.0	94.0	87.1	82.0
3	98.8	95.9	92.2	89.4	97.5	91.6	84.7	79.9
4	99.2	96.3	92.4	89.3	98.4	92.3	85.1	79.8
5	98.6	94.9	90.7	87.5	97.0	89.8	82.0	76.8
Mean	99.0	95.9	92.0	89.0	97.9	91.7	84.4	79.2

METEOROLOGICAL ZONE	HIGHWAY AREAS (75% Impervious)			
	Required Removal Efficiency (%)			
	HSG A	HSG B	HSG C	HSG D
1	98.4	93.3	87.1	82.3
2	99.3	95.7	90.5	86.3
3	98.3	94.0	88.6	84.6
4	98.9	94.5	88.9	84.4
5	98.0	92.6	86.3	81.8
Mean	98.6	94.0	88.3	83.9

TABLE 6-14

**REQUIRED REMOVAL EFFICIENCIES TO ACHIEVE
POST-DEVELOPMENT LESS THAN OR EQUAL TO
PRE-DEVELOPMENT LOADINGS FOR TOTAL PHOSPHORUS**

METEOROLOGICAL ZONE	LOW-DENSITY RESIDENTIAL AREAS				SINGLE-FAMILY RESIDENTIAL AREAS (25% Impervious)			
	Required Removal Efficiency (%)				Required Removal Efficiency (%)			
	HSG A	HSG B	HSG C	HSG D	HSG A	HSG B	HSG C	HSG D
1	95.3	88.9	84.8	82.8	98.4	94.8	92.1	90.5
2	97.5	91.3	86.6	84.4	99.3	96.3	93.4	91.8
3	94.9	89.2	85.0	83.2	98.3	95.2	92.6	91.1
4	96.4	89.9	85.7	81.5	98.8	95.5	92.8	91.1
5	94.4	88.2	84.2	82.5	98.0	94.4	91.8	90.4
Mean	95.7	89.5	85.3	82.9	98.5	95.2	92.5	91.0

METEOROLOGICAL ZONE	SINGLE-FAMILY RESIDENTIAL AREAS (40% Impervious)				MULTI-FAMILY RESIDENTIAL			
	Required Removal Efficiency (%)				Required Removal Efficiency (%)			
	HSG A	HSG B	HSG C	HSG D	HSG A	HSG B	HSG C	HSG D
1	99.0	96.3	93.9	92.4	99.7	98.6	97.5	96.7
2	99.5	97.5	95.2	93.6	99.8	99.1	98.1	97.3
3	98.9	96.6	94.4	93.0	99.6	98.8	97.7	97.0
4	99.3	96.9	94.6	93.0	99.8	98.9	97.8	97.0
5	98.7	96.0	93.7	92.2	99.6	98.5	97.3	96.6
Mean	99.1	96.7	94.4	92.9	99.7	98.8	97.7	96.9

METEOROLOGICAL ZONE	COMMERCIAL AREAS				HIGHWAY AREAS (50% Impervious)			
	Required Removal Efficiency (%)				Required Removal Efficiency (%)			
	HSG A	HSG B	HSG C	HSG D	HSG A	HSG B	HSG C	HSG D
1	99.6	98.5	97.1	96.0	99.2	96.7	93.9	91.9
2	99.8	99.0	97.8	96.9	99.6	97.9	95.4	93.6
3	99.6	98.6	97.4	96.5	99.1	97.0	94.5	92.8
4	99.7	98.8	97.5	96.4	99.4	97.3	94.7	92.8
5	99.5	98.3	96.9	95.8	98.9	96.4	93.6	91.7
Mean	99.7	98.6	97.3	96.3	99.2	97.0	94.4	92.6

METEOROLOGICAL ZONE	HIGHWAY AREAS (75% Impervious)			
	Required Removal Efficiency (%)			
	HSG A	HSG B	HSG C	HSG D
1	99.4	97.6	95.4	93.7
2	99.8	98.5	96.6	95.1
3	99.4	97.9	95.9	94.5
4	99.6	98.0	96.0	94.4
5	99.3	97.4	95.1	93.5
Mean	99.5	97.9	95.8	94.2

Differences between the required removal efficiencies for nitrogen and phosphorus to achieve no net increase in loading under post-development conditions are due primarily to the differences in runoff characteristics for general land use categories between nitrogen and phosphorus. As seen in Table 4-17, nitrogen concentrations increase by a factor of approximately 1.1-3 under developed conditions, compared with values measured under undeveloped conditions. However, total phosphorus concentrations increase by a factor of approximately 3-9, suggesting that removal efficiencies for total phosphorus need to be greater than those which occur for total nitrogen to reach pre-development loading conditions.

A graphical comparison of required removal efficiencies to achieve no net increase in post-development loadings is given in Figure 6-6 for low-density residential areas, Figure 6-7 for single-family residential (25% impervious), Figure 6-8 for single-family residential (40% impervious), Figure 6-9 for high-density residential, Figure 6-10 for commercial areas, Figure 6-11 for highway areas (50% impervious), and Figure 6-12 for highway areas with 75% impervious. A stormwater management system designed according to the goal of the Water Resource Implementation Rule (Chapter 62-40) of 80% removal will achieve a no net increase in nitrogen loadings for low-density residential areas and single-family residential (25% impervious) constructed in HSG B, C, and D soils, single-family residential (40% impervious), and highway areas (50% impervious) constructed in HSG D soils. However, these same developments constructed in HSG A soils and other soil types not listed will fail to meet this criterion and will need supplemental stormwater treatment to achieve the goal of no net increase in nitrogen loadings.

A stormwater management system designed for 80% removal will not achieve a condition of no net increase for total phosphorus for any of the evaluated land use categories. In some cases, removal efficiencies as high as 99% must be achieved to obtain the goal of no net increase in phosphorus loadings, particularly for development constructed in HSG A areas. Even systems constructed to OFW design criteria, equivalent to a 95% annual mass removal, will fail to meet the objective of no net increase in total phosphorus loadings for many combinations of land use category and hydrologic soil group.

6.4 Evaluation of Wet Detention Pond Depth

6.4.1 Theory of Shallow vs. Deep Ponds

One of the most controversial design parameters for stormwater management systems involves the constructed depth for wet detention ponds. As discussed in Section 5.2.2, wet detention systems designed in the St. Johns River Water Management District are limited to a maximum of 12 ft in depth, with a mean depth ranging from 2-8 ft, and relatively short detention times ranging from 14-21 days during wet season conditions. In contrast, the South Florida Water Management District recommends that 25-50% of the pond area be greater than 12 ft in depth which tends to create ponds with detention times on the order of several hundred days.

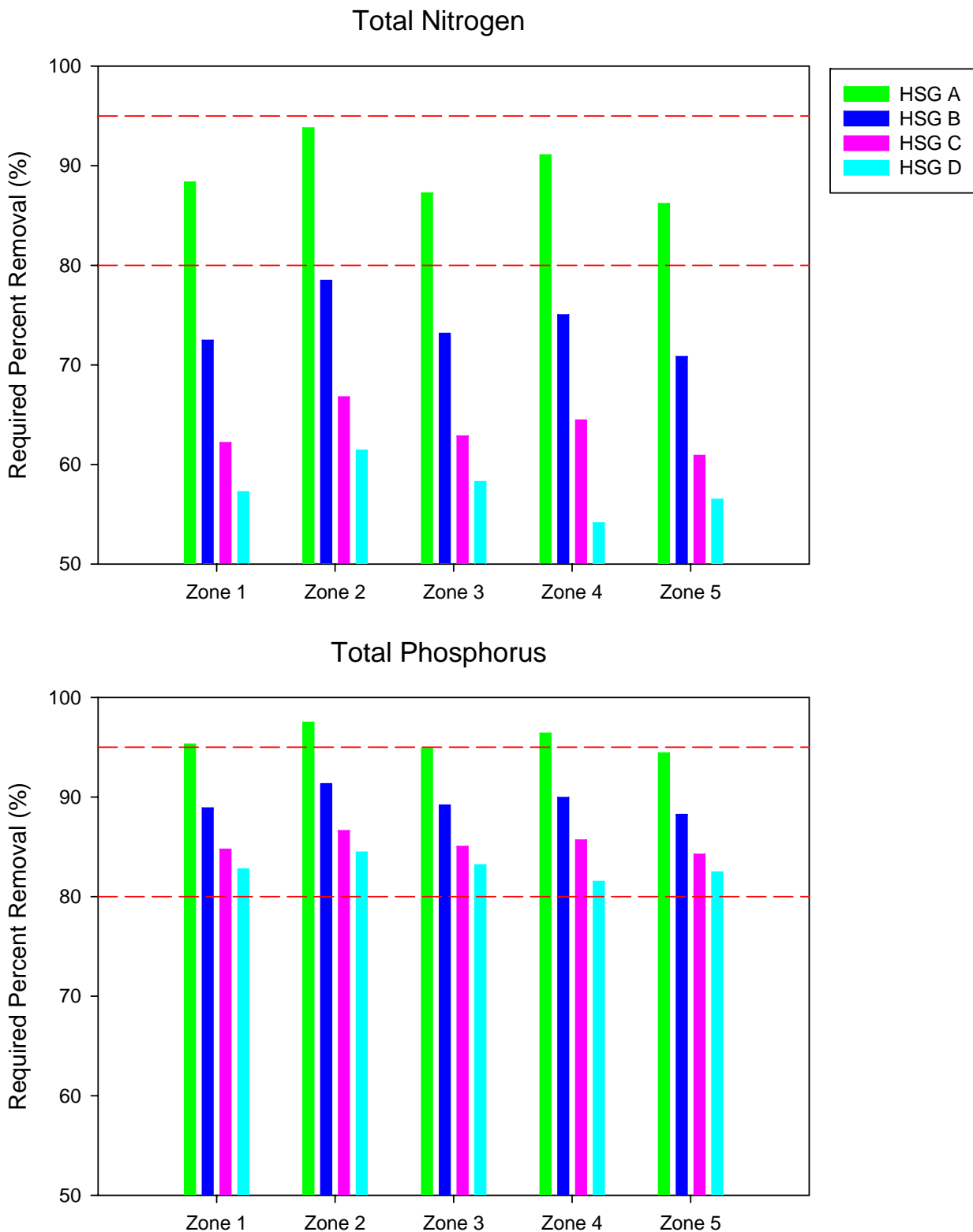

Figure 6-6. Comparison of Estimated Annual Mass Removal Efficiencies to Achieve Post-Development \leq Pre-Development Loadings of Nitrogen and Phosphorus for a Low-Density Residential Development.

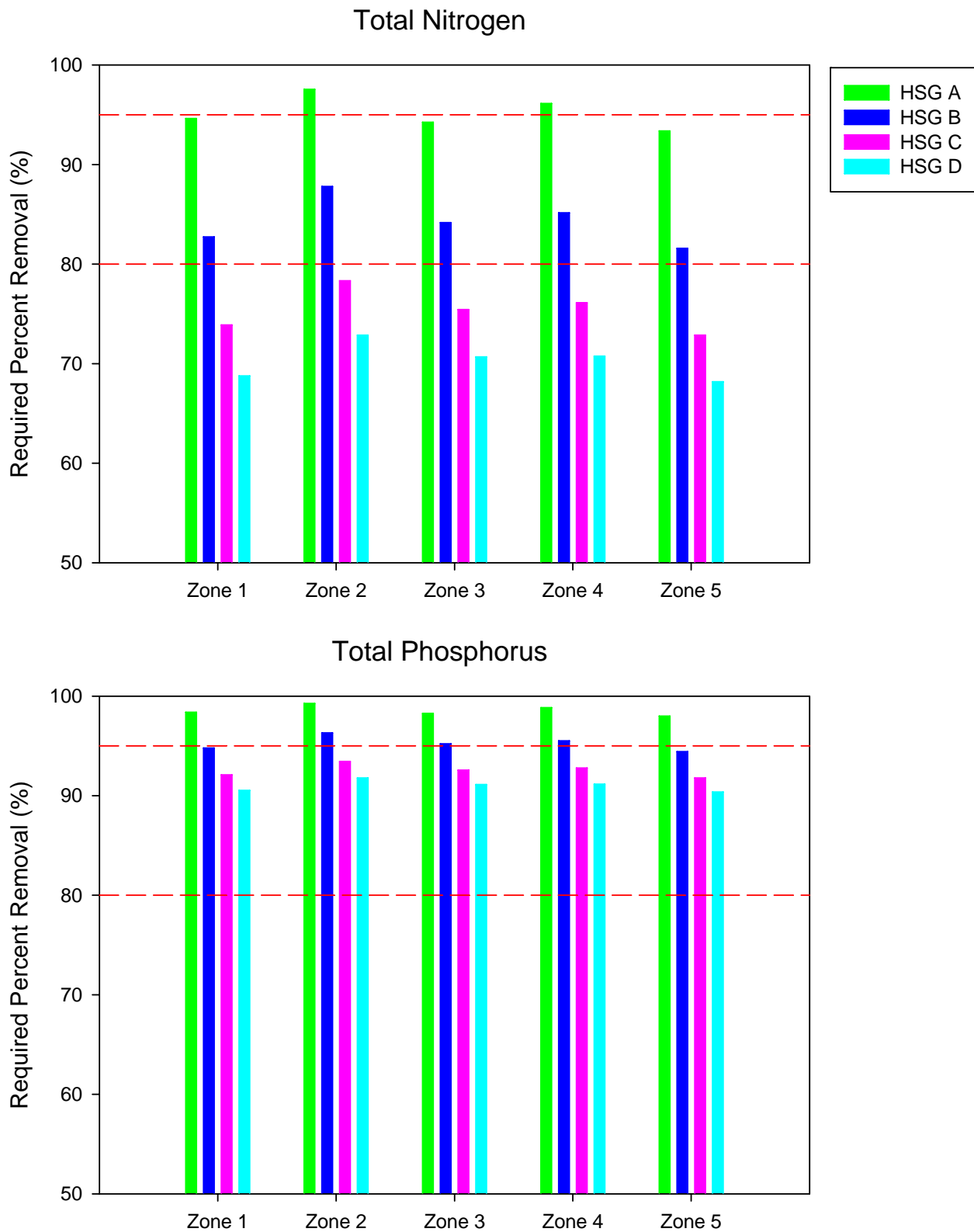

Figure 6-7. Comparison of Estimated Annual Mass Removal Efficiencies to Achieve Post-Development \leq Pre-Development Loadings of Nitrogen and Phosphorus for a Single-Family (25% Impervious) Residential Development.

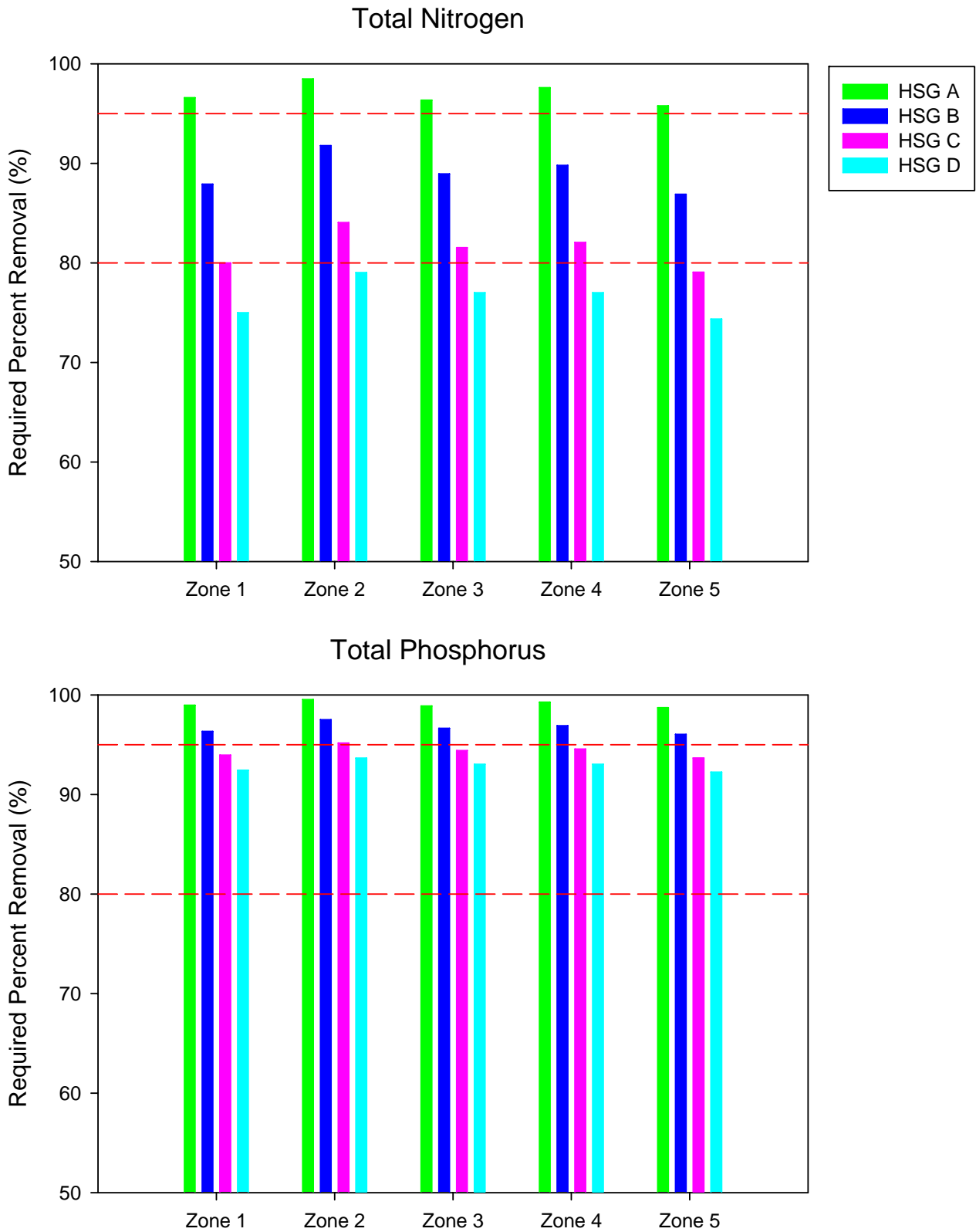

Figure 6-8. Comparison of Estimated Annual Mass Removal Efficiencies to Achieve Post-Development \leq Pre-Development Loadings of Nitrogen and Phosphorus for a Single-Family (40% Impervious) Residential Development.

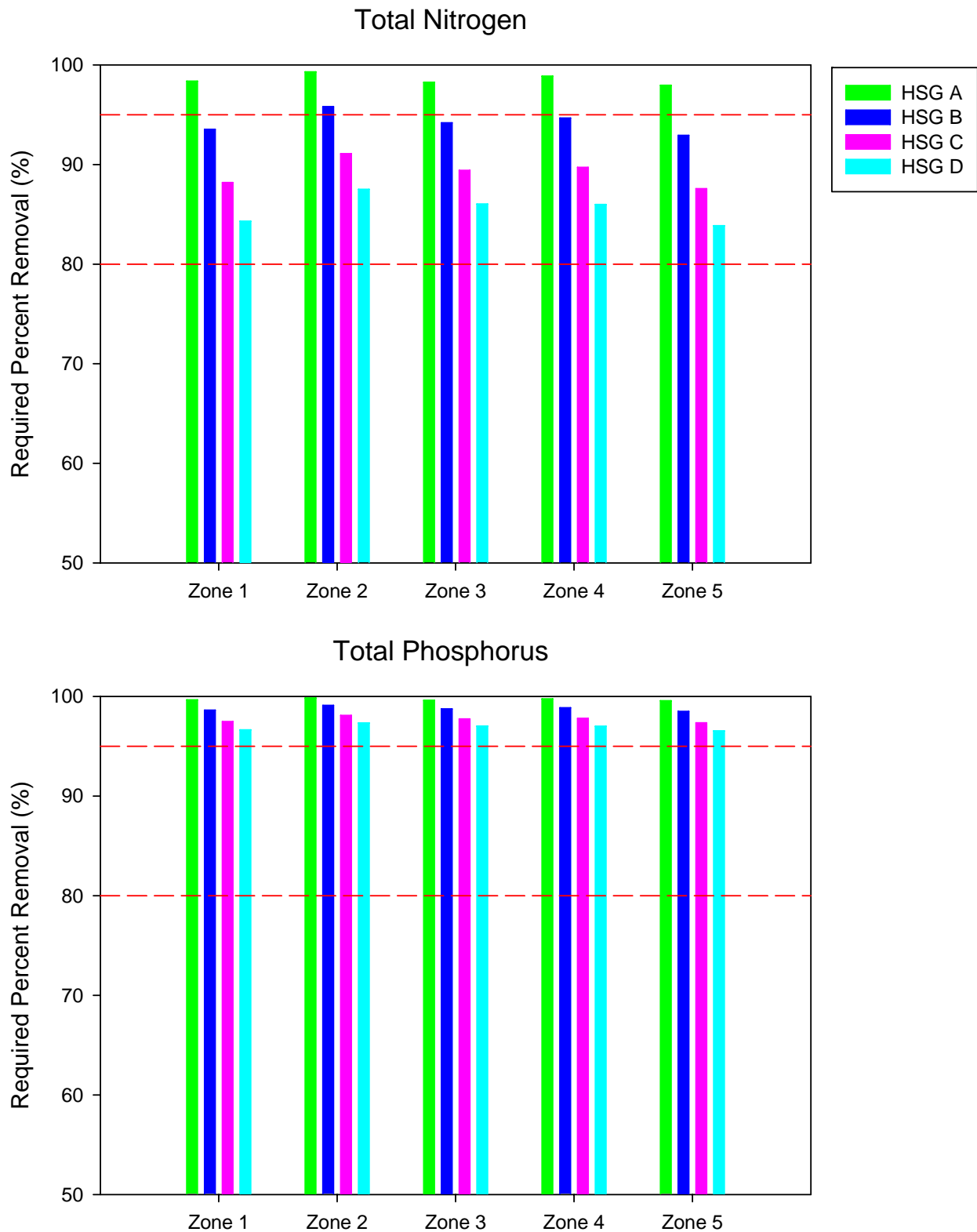

Figure 6-9. Comparison of Estimated Annual Mass Removal Efficiencies to Achieve Post-Development \leq Pre-Development Loadings of Nitrogen and Phosphorus for a Multi-Family Residential Development.

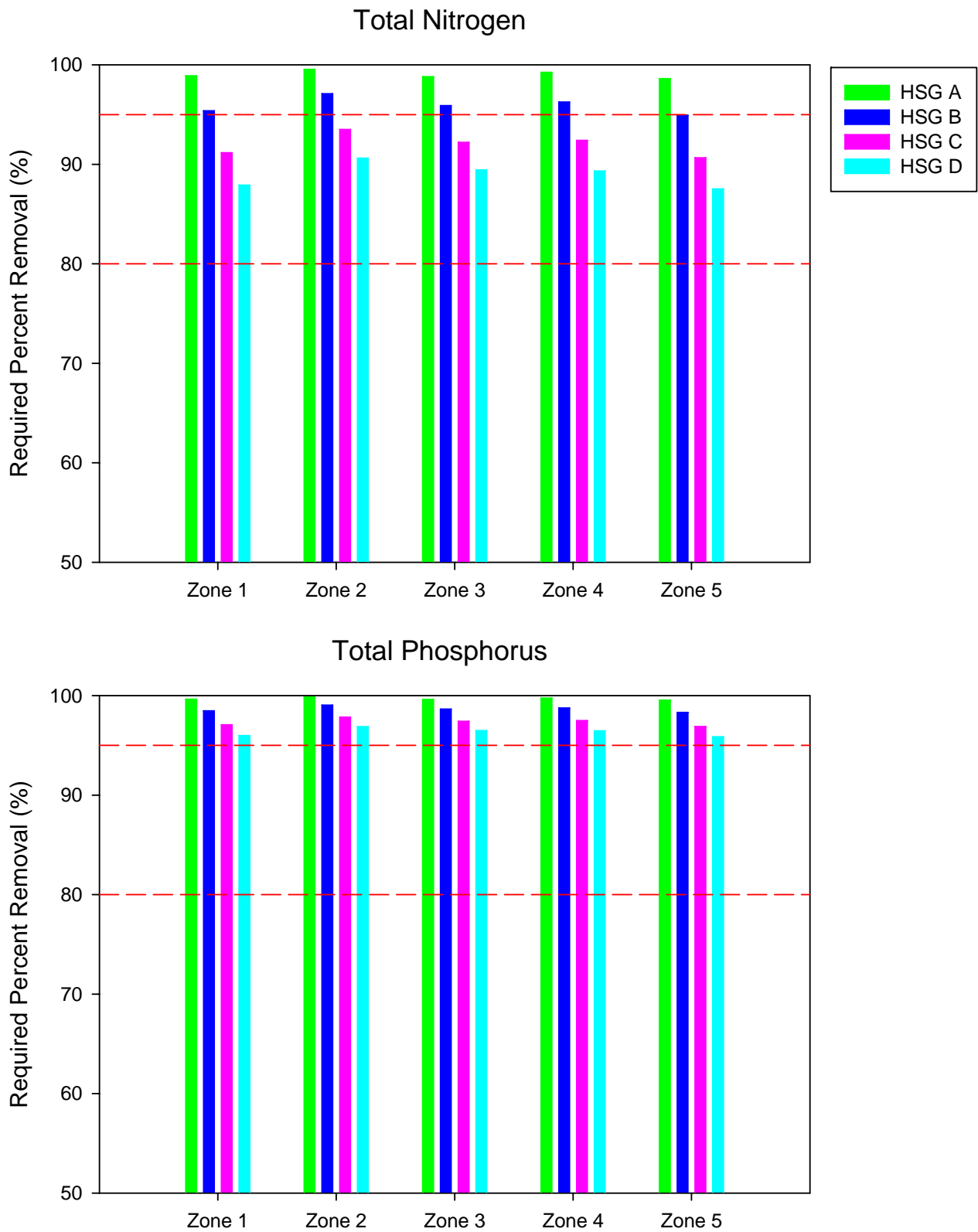

Figure 6-10. Comparison of Estimated Annual Mass Removal Efficiencies to Achieve Post-Development \leq Pre-Development Loadings of Nitrogen and Phosphorus for a Commercial Development.

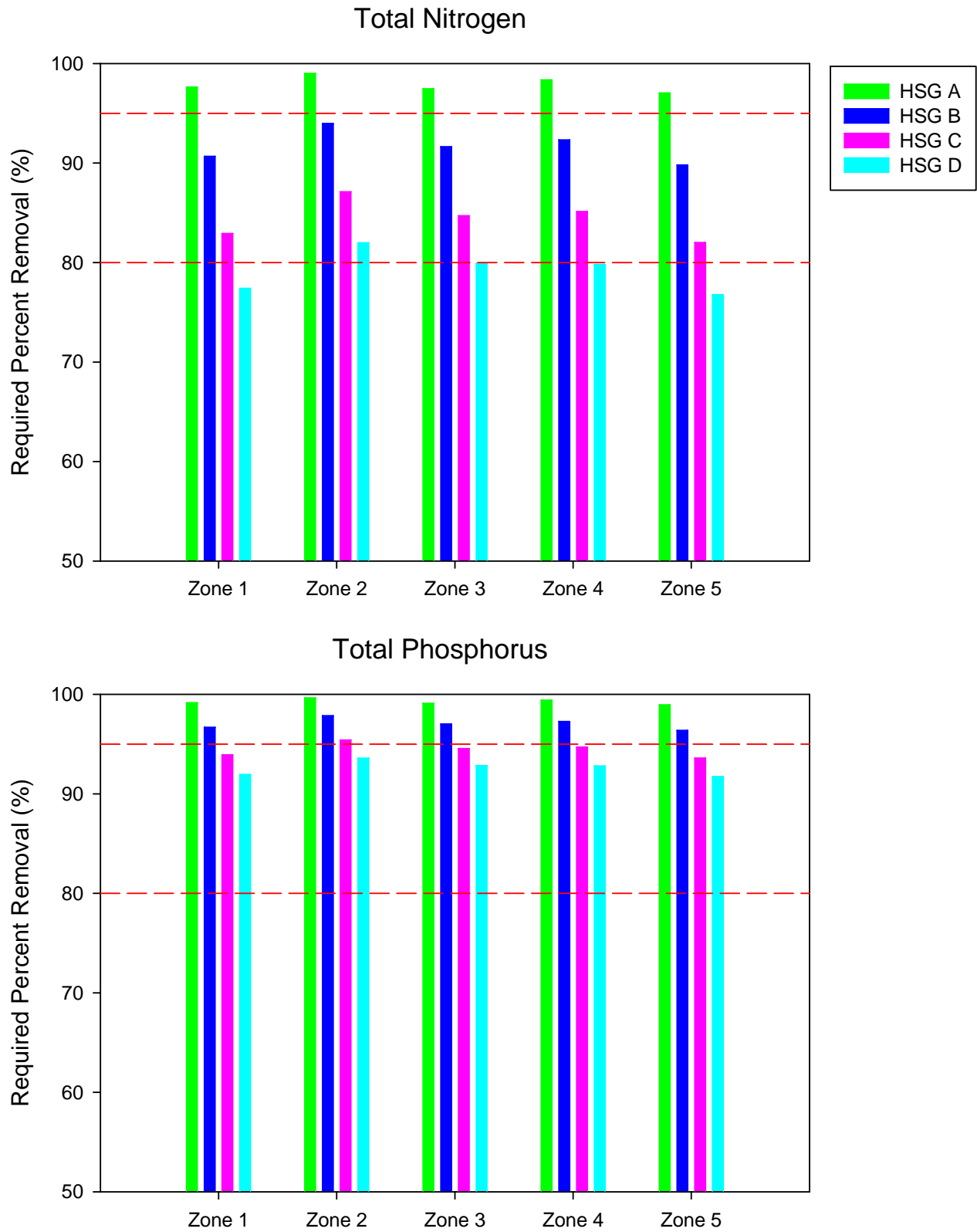

Figure 6-11. Comparison of Estimated Annual Mass Removal Efficiencies to Achieve Post-Development \leq Pre-Development Loadings of Nitrogen and Phosphorus for a Highway (50% Impervious) Development.

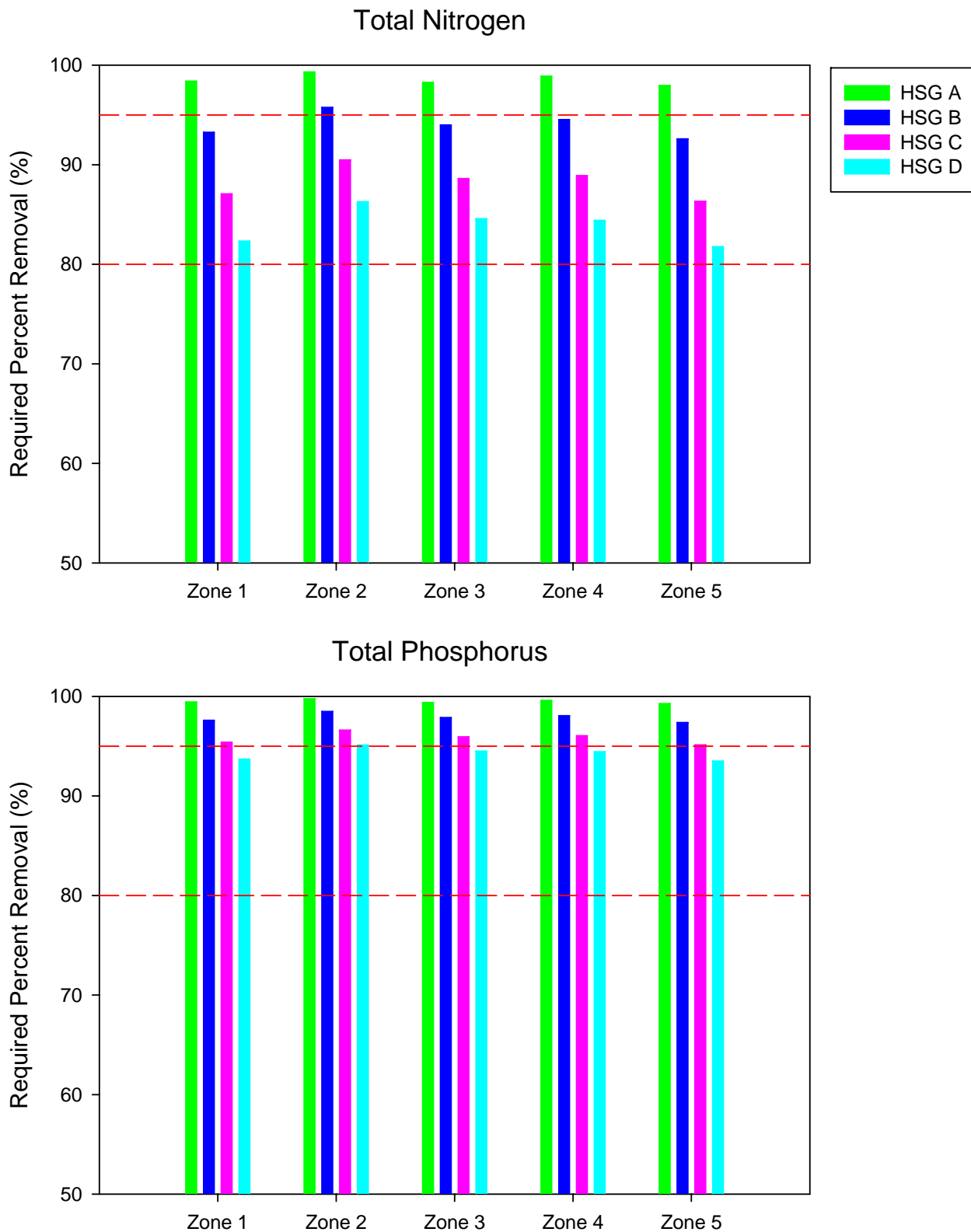

Figure 6-12. Comparison of Estimated Annual Mass Removal Efficiencies to Achieve Post-Development \leq Pre-Development Loadings of Nitrogen and Phosphorus for a Highway (75% Impervious) Development.

Neither of the design criteria outlined in the previous paragraph is supported by specific research projects designed to address allowable depths for wet detention ponds. The depth limitation of 12 ft for wet detention ponds designed in the St. Johns River Water Management District appears to have been influenced by several previous research projects designed to evaluate the effectiveness of a particular wet detention pond design. These ponds, which were coincidentally designed to a maximum depth of approximately 12 ft, maintained aerobic conditions throughout the water column of each pond, resulting in the conclusion that wet detention ponds constructed to a depth of 12 ft would maintain aerobic conditions.

In order to understand factors which may impact the allowable depths for wet detention ponds, it is essential to understand that wet detention ponds are simply man-made lake systems subject to the same physical, chemical, and biological processes which exist in natural lake systems. Virtually every lake in Florida, particularly in urbanized environments, acts as a regional wet detention facility for runoff inputs generated from the surrounding areas. The limnological concepts of nutrient uptake, chemical and biological transformations, and primary productivity are no different in waterbodies which have been assigned permit numbers than in waterbodies which have been assigned formal names.

The underlying assumption in maximizing the pollutant removal effectiveness of a wet detention pond is that aerobic conditions must be maintained throughout the water column at all times. Assuming that aerobic conditions are reflected by dissolved oxygen concentrations in excess of 1 mg/l, this means that dissolved oxygen concentrations must be in excess of 1 mg/l within the water column at all times.

The depth of anoxia in a waterbody, defined as the water depth at which dissolved oxygen concentrations drop below 1 mg/l, is highly correlated with the algal productivity which exists within the pond. At low levels of algal productivity, light penetration can extend to deeper layers of the pond, which increases the portion of the water column in which photosynthetic activities take place and increases the depth of anoxia. As algal productivity increases, light penetration into the water column is restricted, and the depth of anoxia begins to approach closer to the surface. This phenomenon is well documented by limnologists who consistently observe that eutrophic lakes with high levels of algal productivity often develop anoxic conditions at a relatively shallow water depth, while lake systems exhibiting oligotrophic characteristics and low algal productivity often maintain aerobic conditions to depths of 30-40 ft. The fact that a wet detention pond is constructed to a maximum depth of 12 ft in no way guarantees that aerobic conditions will be maintained within the pond at all times. In fact, a wet detention pond with a deeper depth and larger permanent pool volume, receiving the same mass loadings as a 12-ft deep pond, would exhibit substantially lower algal productivity and have a correspondingly deeper depth for the anoxic zone. As a result, the allowable depth of a wet detention pond should be evaluated with respect to the anticipated algal productivity within the pond rather than an arbitrary depth which may or may not achieve the objective of maintaining aerobic conditions within the water column.

Maximizing the depth of a wet detention pond while still maintaining aerobic conditions provides several significant water quality benefits. First, deeper ponds generally have a larger permanent pool volume which decreases the likelihood of water quality violations at the outfall from runoff inputs entering the pond. When a pond has a detention time of several hundred days, runoff inputs into the system reflect a very small percentage of the available permanent pool volume. This permanent pool volume provides significant attenuation and dilution for runoff inputs, minimizing variability in discharges from the pond and water quality violations. On the other hand, runoff inputs into a pond with a relatively short detention time comprise a significantly larger portion of the permanent pool volume, increasing the likelihood of water quality violations at the outfall.

Another advantage of deeper ponds is the increased storage for suspended solids provided in these systems. As shallow detention ponds begin to fill in with sediments, aquatic vegetation (commonly cattails) begins to encroach into the pond, creating significant negative water quality impacts. In deeper ponds, this phenomenon is substantially postponed. Shallow ponds with a short residence time also tend to be highly productive and often have aesthetically unpleasing algal blooms. Homeowners associations often contract with aquatic weed control companies to correct these visual concerns using herbicides or copper-based algicides, both of which decrease the performance efficiency of the pond and increase the likelihood of water quality violations at the pond outfall.

6.4.2 Zonation and Stratification

Typical zonation in a pond or lake is illustrated on Figure 6-13. The upper portions of the water column in a waterbody are typically well mixed, with a relatively uniform temperature. This upper layer, often called the epilimnion, is the area in which the majority of algal production within the lake occurs. In this zone, photosynthesis exceeds respiration, and adequate levels of dissolved oxygen are typically maintained. Lower layers of a lake are often isolated from the upper layers as a result of thermal stratification within the waterbody. Penetration of sunlight into these lower layers is typically poor, and as a result, little algal productivity occurs in these areas. In this lower zone, commonly referred to as the hypolimnion, respiration exceeds photosynthesis, and the water column may become void of dissolved oxygen during portions of the year.

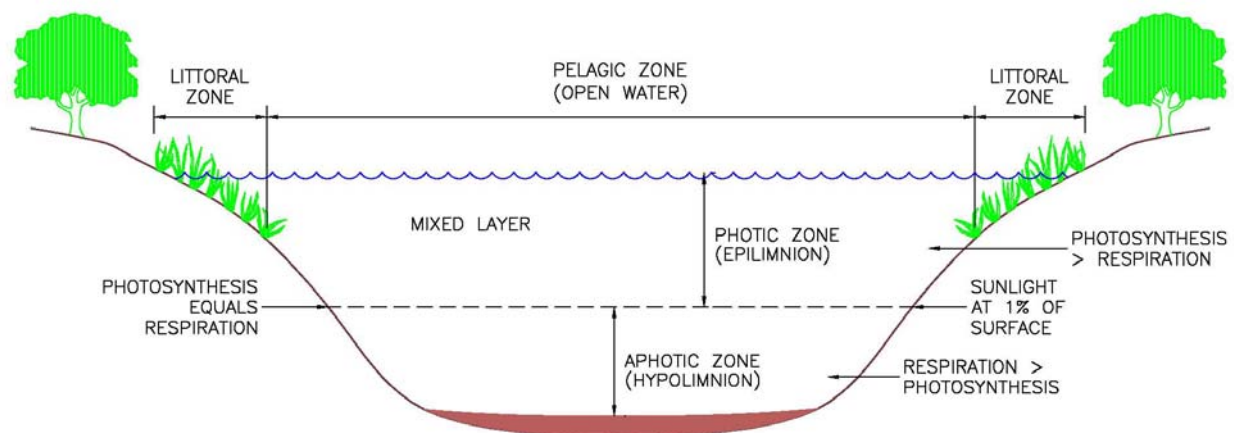

Figure 6-13. Typical Zonation in a Lake or Pond.

Development of stratification in waterbodies occurs primarily as a result of differential absorption of solar energy within the water column resulting in relatively large temperature differences between the upper warm epilimnion water and the lower cooler hypolimnion water. In Florida, temperature differences as high as 8-10°C can occur during the summer months between the epilimnion and the hypolimnion in a deep waterbody. Temperature differences within the water column result in density gradients which inhibit circulation between surface and deeper portions of the water column, resulting in stable stratified conditions.

Under stratified conditions, the hypolimnion becomes isolated from oxygen input mechanisms such as reaeration from the surface and algal production, and anaerobic conditions may develop in deeper waters. Anaerobic or anoxic conditions are considered to occur when dissolved oxygen concentrations in portions of a waterbody decrease to less than 1 mg/l. These conditions may increase the release of ions such as ammonia and orthophosphorus, along with gases such as H₂S and CO₂, from the bottom sediments into the hypolimnion water where significant accumulation of these ions and gases can occur. The accumulated constituents in the hypolimnion can then be circulated into the epilimnion as a result of a destratifying event, such as a prolonged windy period or strong storm event, theoretically resulting in episodes of reduced water quality. Circulation may also occur naturally within a waterbody with seasonal changes in temperature.

Stratified conditions commonly develop as a result of absorption of solar energy by particles in the water column, either as a result of turbidity or by excess algal production near the surface. Both inorganic particles and organic matter can strongly absorb solar radiation and create a significant degree of stratification and a sharp decrease in temperature in the water column at depths below 4-6 feet if large quantities of suspended matter are present in the water column. However, if significant suspended matter is not present in the water column, waterbodies as deep as 20 feet or more may not experience stratification or anaerobic conditions at deeper water depths.

One method of evaluating the potential for stratification in a waterbody is to perform estimates of anticipated algal production and corresponding chlorophyll-a values within the proposed system. If algal production is predicted to be low, generally characterized by chlorophyll-a concentrations less than 5 mg/m³, then the potential for stratification in a waterbody is low, and if it develops, it will occur in relatively deep portions of the water column. The stratification potential increases substantially as chlorophyll-a concentrations increase above these values. If total phosphorus concentrations in a waterbody are known or can be estimated, the corresponding chlorophyll-a concentration can be calculated. Dillon and Rigler (19974) proposed the following empirical relationship between chlorophyll-a and total phosphorus, based on data collected primarily from northern temperate lakes:

$$\log(\text{Chyl-a}) = 1.449 \log TP - 1.136 \quad (\text{Eq. 2})$$

where:

TP = Mean total phosphorus concentration (µg/l)

Once the anticipated algal production and chlorophyll-a values in the aquatic system have been determined, corresponding Secchi disk depths can be estimated based upon a second empirical relationship presented by Dillon and Rigler (1974), also based on data collected primarily from northern temperate lakes, which results in an estimated Secchi disk depth in meters, based upon a chlorophyll-a input in units of mg/m³ according to the following equation:

$$SD = 8.7 \left(\frac{I}{I + 0.47 \text{ Chyl} - a} \right) \quad (\text{Eq. 3})$$

where:

$$\begin{aligned} SD &= \text{Secchi disk depth (m)} \\ \text{Chyl-a} &= \text{Chlorophyll-a concentration (mg/m}^3\text{)} \end{aligned}$$

The Secchi disk is a simple device used to estimate water clarity in a lake or pond. It consists of a weighted circular plate, 20 cm in diameter, with the surface painted with alternating black and white quarters. The depth to which this disk can be seen in the water column is defined as the Secchi disk depth. The Secchi disk depth in a body of water is generally assumed to correspond to a water depth where the available light is approximately 10-15% of the incident light at the water surface.

Although the general relationships referenced previously between total phosphorus, chlorophyll-a, and Secchi disk were developed primarily from data generated on northern temperate lakes, these equations have been utilized extensively within the State of Florida to model water quality characteristics in lakes. However, for purposes of evaluating wet detention pond design, a revised evaluation of these relationships was conducted based specifically on water quality data collected within the State of Florida. As a source of data, the STORET database was searched for existing surface water data which includes simultaneous measurements for total phosphorus, chlorophyll-a, and Secchi disk for waterbodies within the State of Florida. This data search generated in excess of 65,000 measurements which include the three evaluated parameters. Unfortunately, this dataset exceeds the input capabilities for most commonly used statistical programs. As a result, average values were calculated for each monitoring location over the period of record contained within the STORET database. These mean values were used to form a separate database which contained approximately 2467 individual data points. This dataset was then used to perform regression analyses to evaluate relationships between total phosphorus, chlorophyll-a, and Secchi disk specifically for Florida conditions.

A regression analysis was conducted to evaluate the most significant functional forms for the relationships between chlorophyll-a and total phosphorus. This evaluation indicated that a log-log relationship, similar to that expressed as Eq. 2, provides the best-fit between these parameters. This regression analysis was evaluated for outliers by examination of the Student T residuals and Cook's D values. Approximately 327 data points were eliminated from the data set as outliers during this process. The remaining data set contained 2140 data points.

The best-fit relationship between chlorophyll-a and total phosphorus is summarized below:

$$\ln(\text{chyl-a}) = 1.058 \ln(\text{TP}) - 0.934 \quad R^2 = 0.815 \quad (\text{Eq. 4})$$

where:

chl-a = chlorophyll-a concentration (mg/m³)

TP = total phosphorus concentration (µg/l)

The best-fit relationship obtained with Florida data is similar to that originally proposed by Dillon and Rigler (1974) with different coefficients and intercepts. The R² value for this relationship is 0.815 which indicates that the value of total phosphorus explains approximately 82% of the variability in measured chlorophyll-a concentrations. This relationship can be used to estimate chlorophyll-a concentrations in a detention pond based upon estimated concentrations of total phosphorus.

Predictive relationships between Secchi disk depth and chlorophyll-a were also evaluated based upon the Florida lakes data set. A regression analysis for this relationship was also conducted to identify the best-fit relationship between the two variables. A plot of the relationship between Secchi disk depth and chlorophyll-a for Florida lakes is given in Figure 6-14. The best-fit equation for this relationship is a hyperbolic equation which is summarized on Figure 6-14. The R² value of 0.807 for this relationship indicates that chlorophyll-a explains approximately 81% of the variability in Secchi disk depth within a waterbody in Florida. This relationship may be used to estimate the Secchi disk depth in a waterbody based on measured or calculated values of chlorophyll-a.

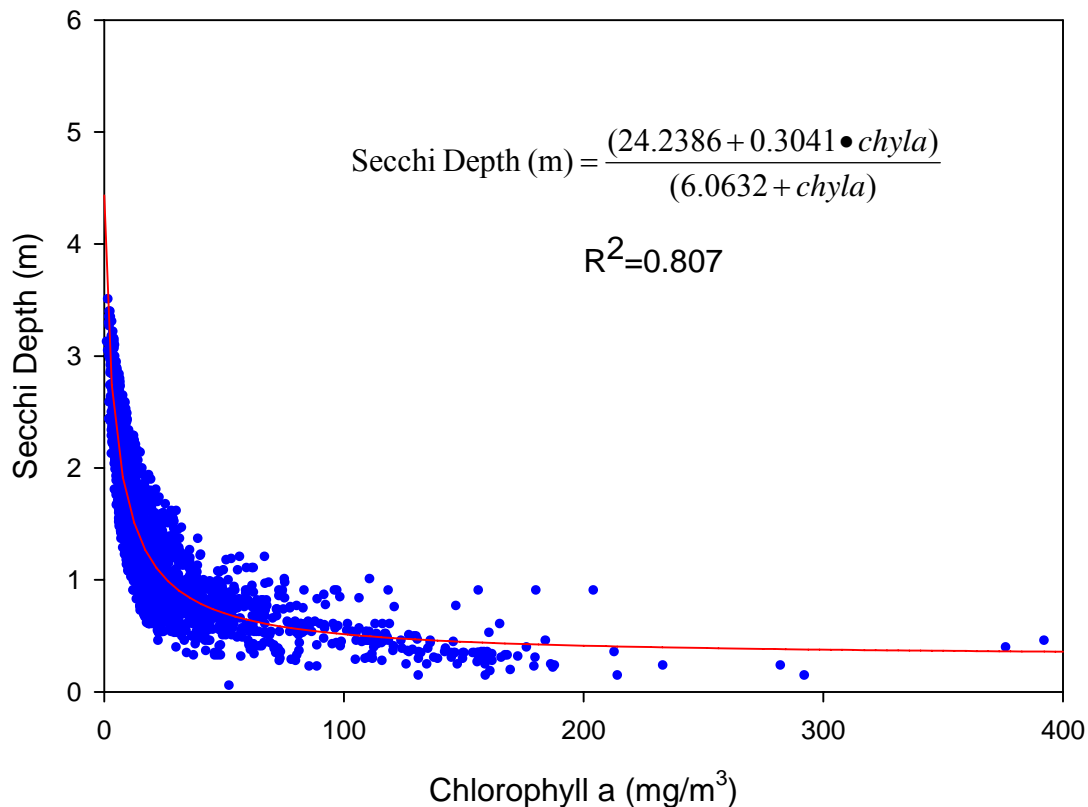

Figure 6-14. Relationship Between Secchi Disk Depth and Chlorophyll-a for Florida Lakes.

Development of stratification and anoxic conditions in a non-colored waterbody, such as a wet detention pond, is directly related to the amount of algal production and the corresponding Secchi disk depth within the water column. Although algal production adds oxygen in areas where active photosynthesis occurs, algal cells also absorb solar radiation and limit the amount of sunlight and corresponding algal productivity at deeper depths within the water column. Wet detention ponds are primarily phosphorus-limited systems. Since algal production is limited primarily by inputs of total phosphorus, phosphorus is also an important variable in determining the depth of anoxia.

A linear regression was developed to predict the depth of anoxia in a waterbody as a function of ambient concentrations of chlorophyll-a, total phosphorus, and Secchi disk depth. The depth of anoxia was obtained from field measured dissolved oxygen profiles collected in a waterbody at the time of sample collection for laboratory analyses. A data set was developed containing 426 sets of measurements of Secchi disk depth, chlorophyll-a, total phosphorus, and depth of anoxia, defined as dissolved oxygen concentrations less than 1 mg/l, for waterbodies in Central and South Florida. The data were generated from field monitoring and laboratory analyses conducted by ERD over the past 20 years. The data set was evaluated for outliers by examination of the Student T residuals and Cook's D values. A total of 54 data points was eliminated as outliers. Both linear and log transformations were performed on the variables to obtain the "best-fit" model which maximizes R^2 while minimizing the mean square error (MSE). This modeling exercise is designed to maximize the predictability of the model rather than to examine functional forms. The resulting linear regression relationship for the variables indicates that the depth of anoxia is regulated primarily by Secchi disk depth according to the following relationship:

$$\text{Anoxic Depth} = 3.035 \times \text{Secchi Disk Depth (m)} - 0.004979 \quad (\text{Eq. 5})$$

$$+ 0.02164 \times \text{Total P } (\mu\text{g/l}) + 0.02164 \times \text{chl-a } (\text{mg/m}^3)$$

$$R^2 = 0.951$$

where:

$$\text{Anoxic Depth} = \text{depth of anoxia (m)}$$

The above equation is valid for:

$$\begin{aligned} 0.25 \text{ m} < \text{anoxic depth} < 9.0 \text{ m} \\ 0.09 \text{ m} < \text{Secchi disk depth} < 3.49 \text{ m} \\ 1 \mu\text{g/l} < \text{Total P} < 498 \mu\text{g/l} \\ 1 \text{ mg/m}^3 < \text{chl-a} < 332 \text{ mg/m}^3 \end{aligned}$$

Regression statistics for the anoxic depth model are given in Table 6-16.

TABLE 6-16
REGRESSION STATISTICS FOR
ANOXIC DEPTH MODEL

VARIABLE	PARAMETER ESTIMATES	LEVEL OF SIGNIFICANCE (%)	STANDARDIZED ESTIMATE
Total P	-0.004979	> 99.99	- 0.070
Secchi Disk	3.035	> 99.99	0.217
Chlorophyll-a	0.02164	> 99.99	0.911

The R^2 value for this relationship is 0.951 which indicates that the regression model explains 95.1% of the variability in estimated anoxic depth. If the Secchi disk depth, total phosphorus, and chlorophyll-a for a proposed wet detention pond can be estimated based upon the relationships summarized previously, then the depth of anoxia can be estimated using Eq. 5. This depth of anoxia would be an estimate of the maximum depth to which the wet detention pond could be constructed without generating anoxic conditions in lower portions of the water column.

SECTION 7

DESIGN EXAMPLES

Several design examples were developed to illustrate the basic methodology which would be utilized by a design engineer to develop an appropriate stormwater management system to meet the proposed modifications to existing stormwater design criteria summarized in Section 6. Design examples are provided based upon stormwater criteria intended to meet both the 80% and 95% pollutant reduction target goals outlined in Chapter 62-40. These design examples are also intended to illustrate differences in required water quality treatment volumes for different meteorological zones within the State of Florida based on differences in total annual rainfall and the frequency distribution for individual rain events. In addition, design examples are also provided to illustrate treatment requirements necessary to achieve a condition of no net increase in pollutant loadings for a developed site under post-development conditions.

7.1 Design Example #1:

Stormwater Treatment to Meet the 80% Pollution Reduction Target Goal

Determine the water quality treatment requirements for a 100-acre proposed single-family residential site. Perform separate calculations for identical projects located in Pensacola (Zone 1), Orlando (Zone 2), and Key West (Zone 3). A summary of pre- and post-development conditions is given below.

Calculate Pre- and Post-Development Conditions

Pre-Development Conditions

1. **Land Use:** 90 acres - mixture of rangeland/forest (fair condition)
 10 acres – isolated wetlands

2. **Ground Cover/Soil Types:** Rangeland/Forest – Hydrologic Soil Group (HSG) D
 Wetland – hydric soils

3. **Impervious Areas:** 0% impervious, 0% Directly Connected Impervious Area (DCIA)

Post Development Conditions

1. **Land Use:** 90 acres of single-family residential
 5 acres of stormwater management systems
 5 acres of preserved wetlands

2. **Ground Cover/Soil Types**

- A. Residential areas will be covered with lawns in good condition
- B. Soil types will remain HSG D

3. **Impervious/DCIA Areas**

- A. Residential areas will be 25% impervious, 75% of which will be DCIA
 Impervious Area = 25% of residential area = 90 ac x 0.25 = 22.50 acres
 DCIA Area = 22.50 acres x 0.75 = 16.88 acres
 DCIA Percentage = (16.88 ac/90.0 ac) x 100 = 18.7% of developed area

4. **Calculate composite non-DCIA curve number from TR-55:**

Curve number for lawns in good condition in HSG D = 80

Areas of lawns = 90 acres total – 22.50 ac impervious area = 67.50 acres pervious area

Impervious area which is not DCIA = 22.50 ac – 16.88 ac = 5.62 ac

Assume a curve number of 98 for impervious areas

Non-DCIA curve number =

$$\frac{67.50 \text{ ac } (80) + 5.62 \text{ ac } (98)}{67.50 \text{ ac} + 5.62 \text{ ac}} = 81.4$$

Calculate Treatment Requirements for 80% Removal

Estimation of treatment requirements assumes that only dry retention and wet detention are capable of approaching the 80% pollutant reduction goal.

1. **Dry Retention**

A. **Pensacola Project (Zone 1)**

The required retention depth to achieve an annual removal efficiency of 80% in the Pensacola (Zone 1) area is determined from Table 6-1 (Zone 1) based on DCIA percentage and the non-DCIA CN value. For this project:

DCIA Percentage = 18.75% of developed area

Non-DCIA CN = 81.4

The required dry retention depth is obtained by iterating between DCIA percentages of 10 and 20, and for non-DCIA CN values between 80 and 90. The required dry retention depth = 1.52 inches over the developed area.

B. Orlando Project (Zone 2)

If the project was located in Orlando (Central Zone), the required dry retention depth would be slightly different due to differences in the distribution of rain events. The required retention depth would be obtained from Table 6-1 (Zone 2) by iterating between DCIA percentages of 10 and 20, and for non-DCIA CN values between 80 and 90. The required dry retention depth = 0.96 inches over the developed area.

C. Key West Project (Zone 3)

If the project was located in Key West (Zone 3), the required dry retention depth would be slightly different due to differences in the distribution of rain events. The required retention depth would be obtained from Table 6-1 (Zone 3) by iterating between DCIA percentages of 10 and 20, and for non-DCIA CN values between 80 and 90. The required dry retention depth = 1.66 inches over the developed area.

2. Wet Detention

Treatment Train Approach

Calculation of design criteria for a wet detention pond is based on determining the detention time required to achieve the desired pollutant removal efficiency of 80%. For practical purposes, this efficiency is assumed to apply to nitrogen and phosphorus since other pollutants such as BOD and TSS are typically removed at a faster rate than nutrients. As discussed in Section 5.2.2, wet detention systems are capable of providing annual mass load reduction for phosphorus in excess of 80% at extended detention times (> 200 days). However, wet detention ponds are not capable of providing 80% removal for total nitrogen since removal efficiency for total nitrogen in wet detention ponds appears to peak at approximately 40-45%.

Therefore, when wet detention is desired as a treatment option, pre-treatment must be provided to enhance the total system performance efficiency to a minimum of 80% for total nitrogen. Since dry retention provides the best pre-treatment in a minimal space, dry retention appears to be the pre-treatment system of choice for this application. There are many combinations of dry retention and wet detention which can provide the desired 80% removal.

Assume that a wet detention pond is designed with a residence time of 200 days.

Anticipated TN removal (Figure 5-10) =

$$Eff = \frac{(43.75 \times t_d)}{(4.38 + t_d)} = \frac{44.72 \times 200}{5.46 + 200} = 42.8\%$$

Anticipated TP removal (Figure 5-9) =

$$Eff = 40.13 + 6.372 \ln(t_d) + 0.213 (\ln t_d)^2 = 40.13 + 6.372 \ln(200) + 0.213 (\ln 200)^2 = 79.9\%$$

Although the wet detention pond approaches the 80% removal criteria for TP, the removal for TN is only 42.8%. Therefore, the remaining efficiency is achieved using dry detention. The required efficiency for the dry retention is calculated by Eq. 1 below:

$$\text{Treatment Train Efficiency} = Eff_1 + (1 - Eff_1) \times Eff_2 \quad (\text{Eq. 1})$$

where: Eff_1 = required efficiency of dry retention
 Eff_2 = efficiency of wet detention

$$0.8 = Eff_1 + (1 - Eff_1) \times 0.428$$

$$Eff_1 = 0.650 = 65.0\%$$

2A. PENSACOLA (ZONE 1) PROJECT

The required dry retention volume is estimated from the tables given in Appendix D using the development characteristics:

DCIA Percentage = 18.75% of developed area

Non-DCIA CN = 81.4

1. Required Dry Retention Depth

From Appendix D (Zone 1), the required removal efficiency of 65.0% is achieved with a dry retention depth between 0.75 and 1.00 inch.

For a dry retention depth of 0.75 inch, the treatment efficiency is obtained by iterating between DCIA percentages of 10 and 20, and for non-DCIA CN values between 80 and 90. The efficiency for the project conditions is 63.4%.

For a dry retention depth of 1.00 inch, the treatment efficiency is obtained by iterating between DCIA percentages of 10 and 20, and for non-DCIA CN values between 80 and 90. The efficiency for the project conditions is 70.5%.

By iterating between 0.75 inch (63.4%) and 1.00 inch (70.5%), the dry retention depth required to achieve 65.0% removal is 0.81 inch.

Therefore, the required treatment train will consist of:

- a. 0.81 inch dry retention, followed by
- b. Wet detention pond with a 200-day mean residence time

Based on the relationships given in Figures 5-9 and 5-10, the removal efficiencies for TN and TP increase very little at detention times in excess of 200 days. Although the pond size may be increased (if desired) for fill or other purposes, the required dry retention pre-treatment depth will not be significantly reduced. However, if the pond residence time is decreased below 200 days, then the dry retention pre-treatment depth will increase correspondingly.

2. Wet Detention Pond Characteristics

The required physical characteristics of the wet detention pond are determined based on the desired residence time and the impacts of the proposed dry retention pre-treatment.

a. Calculate annual runoff inputs to pond

The annual runoff coefficient for the development can be estimated using the tables included in Appendix C (Zone 1).

For: DCIA = 18.75% and non-DCIA CN = 81.4

The estimated "C" value is obtained by iteration as discussed previously.

Annual C Value = 0.304

The annual rainfall for the Pensacola area = 65.5 inches (Appendix A.3)

Annual generated runoff volume =

$$90 \text{ acres} \times 65.5 \text{ inches/year} \times 1 \text{ ft}/12 \text{ inches} \times 0.304 = 149.34 \text{ ac-ft/yr}$$

The calculated efficiency of 65.0% for the dry retention pre-treatment means that 65.0% of the annual runoff volume will be infiltrated into the ground and will not discharge directly into the wet detention pond. The annual runoff volume which reaches the pond is calculated as:

$$\text{Annual Inputs to Pond} = 149.34 \text{ ac-ft/yr} \times (1 - 0.650) = 52.27 \text{ ac-ft/yr}$$

For a 200-day residence time, the pond volume will be:

$$52.27 \text{ ac-ft/yr} \times 1 \text{ year}/365 \text{ days} \times 200 \text{ days} = 28.64 \text{ ac-ft}$$

Assuming a mean pond depth of 8 ft, the required pond area =

$$\text{Pond Area} = 28.64 \text{ ac-ft} \times 1/8 \text{ ft} = \underline{3.58 \text{ ac}} = 4\% \text{ of project area}$$

b. Estimate maximum allowable pond depth

The maximum allowable pond depth is directly related to the anticipated algal productivity within the pond. Assuming that wet detention ponds are primarily phosphorus-limited ecosystems, the productivity can be estimated based on the mean TP concentration.

1. Estimate runoff characteristics

For a single-family residential land use, the event mean concentration (emc) for TP in runoff can be obtained from Table 4-17:

$$TP = 0.327 \text{ mg/l (single-family residential)}$$

2. Calculate TP loading to wet detention pond

After the dry retention pre-treatment, the annual runoff input to the pond = 52.27 ac-ft/yr

TP load to pond =

$$52.27 \text{ ac-ft/yr} \times \frac{43,560 \text{ ft}^2}{\text{ac}} \times \frac{7.48 \text{ gal}}{\text{ft}^3} \times \frac{3.785 \text{ liter}}{\text{gal}} \times \frac{0.327 \text{ mg}}{\text{liter}} \times \frac{1 \text{ kg}}{10^6 \text{ mg}} = 21.08 \text{ kg TP/yr}$$

3. Calculate TP concentration in pond

At the proposed 200-day residence time, the TP removal was previously estimated as 79.9%.

Annual mass of TP remaining =

$$21.08 \text{ kg TP/yr} \times (1 - 0.799) = 4.24 \text{ kg TP/yr}$$

The mass will be distributed within the pond permanent pool volume (28.64 ac-ft) and the pond outflow. Assuming that inflow and outflow are approximately equal, the outflow will be 52.27 ac-ft.

Mean pond concentration =

$$\frac{4.24 \text{ kg TP}}{\text{yr}} \times \frac{1 \text{ yr}}{(52.27 + 28.64 \text{ ac-ft})} \times \frac{1 \text{ ac}}{43,560 \text{ ft}^2} \times \frac{1 \text{ ft}^3}{7.48 \text{ gal}} \times \frac{1 \text{ gal}}{3.785 \text{ liter}} \times \frac{10^6 \text{ mg}}{\text{kg}} = 0.042 \text{ mg TP/liter} = 42 \text{ } \mu\text{g TP/liter}$$

4. Calculate mean chlorophyll-a concentration in pond

The relationship between TP and chlorophyll-a in a Florida waterbody is expressed by the following relationship:

$$\ln(\text{chl-a}) = 1.058 \ln(\text{TP}) - 0.934 \quad (\text{Eq. 4})$$

where: chl-a = chlorophyll-a concentration (mg/m³)
 TP = total P concentration (μg/l)

$$\ln(\text{chl-a}) = 1.058 \ln(42) - 0.934$$

$$\text{chl-a} = e^{3.02} = 20.5 \text{ mg/m}^3$$

5. Calculate mean Secchi disk depth

The relationship between chlorophyll-a and Secchi disk depth in a Florida waterbody is expressed by the following relationship:

$$SD = \frac{24.2386 + [(0.3041)(\text{chl} - a)]}{(6.0632 + \text{chl} - a)}$$

where: SD = Secchi disk depth (m)
 chl-a = chlorophyll-a (mg/m³)

$$SD = \frac{24.2386 + [(0.3041)(20.5)]}{(6.0632 + 20.5)} = 1.15 \text{ m} = 3.76 \text{ ft}$$

6. Calculate depth of anoxic conditions in pond

Using the relationship expressed in Eq. 5, the depth of anoxic conditions within the pond can be estimated as follows:

$$\text{Depth of } DO < 1 = 3.035 \times \text{Secchi} + 0.02164 \times (\text{chl-a}) - 0.004979 \times \text{Total P}$$

where:

Depth of DO < 1	=	anoxic depth (m)
Secchi	=	Secchi disk depth (m)
chl-a	=	chlorophyll-a concentration (mg/m ³)
Total P	=	total phosphorus concentration (µg/l)

$$\text{Depth of DO} < 1 = 3.035 (1.15) + 0.02164 (20.5) - 0.004979 (42) = \underline{3.73 \text{ m}} = \underline{12.2 \text{ ft}}$$

If the proposed pond depth exceeds the estimated anoxic zone depth of 12.2 ft, aeration or other mixing will be required for areas deeper than 12.2 ft to maintain a well mixed water column. The aeration or mixing must be sufficient to mix the water column to the maximum pond depth. The specific design of the required system should be selected by a qualified aeration specialist.

As an alternative to providing aeration or mixing within the pond, the required permanent pool volume could be considered as only the volume above the anoxic zone and not the entire volume of the pond. Areas below the anoxic depth would be considered as dead storage, although these areas would provide a significant storage volume for collected solids.

If the pond is modified, based on the results of the calculated anoxic zone depth, the calculations would need to be redone to estimate new values for total phosphorus, Secchi disk depth, chlorophyll-a, and depth of anoxia to demonstrate that the new design meets the required permanent pool volume above the zone of anoxia.

7. Estimate pond dimensions

For the estimation of pond dimensions, assume that the mean depth (pond volume/pond area) is 2/3 of the maximum depth.

$$\text{Mean pond depth} = 12.2 \text{ ft} \times 2/3 = 8.13 \text{ ft}$$

$$\text{Pond surface area} = \text{pond volume}/\text{mean depth} = 28.64 \text{ ac-ft}/8.13 \text{ ft} = 3.52 \text{ ac}$$

2B. ORLANDO (ZONE 2) PROJECT

The required dry retention volume is estimated from the tables given in Appendix D using the development characteristics:

$$\text{DCIA Percentage} = 18.75\% \text{ of developed area}$$

$$\text{Non-DCIA CN} = 81.4$$

1. Required Dry Retention Depth

From Appendix D (Zone 2), the required removal efficiency of 65.0% is achieved with a dry retention depth between 0.25 and 0.50 inch.

For a dry retention depth of 0.50 inch, the treatment efficiency is obtained by iterating between DCIA percentages of 10 and 20, and for non-DCIA CN values between 80 and 90. The efficiency for the project conditions is 65.7%.

For a dry retention depth of 0.25 inch, the treatment efficiency is obtained by iterating between DCIA percentages of 10 and 20, and for non-DCIA CN values between 80 and 90. The efficiency for the project conditions is 49.0%.

By iterating between 0.25 inch (49.0%) and 0.50 inch (65.7%), the dry retention depth required to achieve 65.0% removal is 0.49 inch.

Therefore, the required treatment train will consist of:

- a. 0.49 inch dry retention, followed by
- b. Wet detention pond with a 200-day mean residence time

2. Wet Detention Pond Characteristics

The required physical characteristics of the wet detention pond are determined based on the desired residence time and the impacts of the proposed dry retention pre-treatment.

A. Calculate annual runoff inputs to pond

The annual runoff coefficient for the development can be estimated using the tables included in Appendix C (Zone 2).

For: DCIA = 18.75% and non-DCIA CN = 81.4

The estimated "C" value is obtained by iteration as discussed previously.

Annual C Value = 0.253

The annual rainfall for the Orlando area = 50.0 inches (Appendix A.3)

Annual generated runoff volume =

$$90 \text{ acres} \times 50.0 \text{ inches/year} \times 1 \text{ ft/12 inches} \times 0.253 = 94.92 \text{ ac-ft/yr}$$

The calculated efficiency of 65.0% for the dry retention pre-treatment means that 65.0% of the annual runoff volume will be infiltrated into the ground and will not discharge directly into the wet detention pond. The annual runoff volume which reaches the pond is calculated as:

$$\text{Annual Inputs to Pond} = 94.92 \text{ ac-ft/yr} \times (1 - 0.650) = 33.22 \text{ ac-ft/yr}$$

For a 200-day residence time, the pond volume will be:

$$33.22 \text{ ac-ft/yr} \times 1 \text{ year/365 days} \times 200 \text{ days} = 18.21 \text{ ac-ft}$$

B. Estimate maximum allowable pond depth

The maximum allowable pond depth is directly related to the anticipated algal productivity within the pond. Assuming that wet detention ponds are primarily phosphorus-limited ecosystems, the productivity can be estimated based on the mean TP concentration.

1. Estimate runoff characteristics

For a single-family residential land use, the emc for TP in runoff can be obtained from Table 4-17:

$$TP = 0.327 \text{ mg/l (single-family residential)}$$

2. Calculate TP loading to wet detention pond

After the dry retention pre-treatment, the annual runoff input to the pond = 33.22 ac-ft/yr

TP load to pond =

$$33.22 \text{ ac-ft/yr} \times \frac{43,560 \text{ ft}^2}{\text{ac}} \times \frac{7.48 \text{ gal}}{\text{ft}^3} \times \frac{3.785 \text{ liter}}{\text{gal}} \times \frac{0.327 \text{ mg}}{\text{liter}} \times \frac{1 \text{ kg}}{10^6 \text{ mg}} = 13.40 \text{ kg TP/yr}$$

3. Calculate TP concentration in pond

At the proposed 200-day residence time, the TP removal was previously estimated as 79.9%.

Annual mass of TP remaining in water column =

$$13.40 \text{ kg TP/yr} \times (1 - 0.799) = 2.69 \text{ kg TP/yr}$$

Remaining TP mass will be distributed between the pond volume and the annual outflow:

$$= 18.21 \text{ ac-ft} + 33.22 \text{ ac-ft} = 51.43 \text{ ac-ft}$$

Mean pond concentration =

$$\frac{2.69 \text{ kg TP}}{\text{yr}} \times \frac{1 \text{ yr}}{51.43 \text{ ac-ft}} \times \frac{1 \text{ ac}}{43,560 \text{ ft}^2} \times \frac{1 \text{ ft}^3}{7.48 \text{ gal}} \\ \times \frac{1 \text{ gal}}{3.785 \text{ liter}} \times \frac{10^6 \text{ mg}}{\text{kg}} = 0.042 \text{ mg TP/liter} = 42 \text{ } \mu\text{g TP/liter}$$

4. Calculate mean chlorophyll-a concentration in pond

The relationship between TP and chlorophyll-a in a Florida waterbody is expressed by the following relationship:

$$\ln(\text{chyl-a}) = 1.058 \ln(\text{TP}) - 0.934 \quad (\text{Eq. 4})$$

where: chyl-a = chlorophyll-a concentration (mg/m^3)

TP = total P concentration ($\mu\text{g}/\text{l}$)

$$\ln(\text{chyl-a}) = 1.058 \ln(42) - 0.934$$

$$\text{chyl-a} = e^{3.02} = 20.5 \text{ mg}/\text{m}^3$$

5. Calculate mean Secchi disk depth

The relationship between chlorophyll-a and Secchi disk depth in a Florida waterbody is expressed by the following relationship:

$$SD = \frac{24.2386 + [(0.3041)(\text{chyl} - a)]}{(6.0632 + \text{chyl} - a)}$$

where: SD = Secchi disk depth (m)

chyl-a = chlorophyll-a (mg/m^3)

$$SD = \frac{24.2386 + [(0.3041)(20.5)]}{(6.0632 + 20.5)} = 1.15 \text{ m} = 3.76 \text{ ft}$$

6. Calculate depth of anoxic conditions in pond

Using the relationship expressed in Eq. 5, the depth of anoxic conditions within the pond can be estimated as follows:

$$\text{Depth of } DO < 1 = 3.035 \times \text{Secchi} + 0.02164 (\text{chl-a}) - 0.004979 \times \text{Total P}$$

where:

Depth of DO < 1	=	anoxic depth (m)
Secchi	=	Secchi disk depth (m)
chl-a	=	chlorophyll-a concentration (mg/m ³)
Total P	=	total phosphorus concentration (µg/l)

$$\text{Depth of } DO < 1 = 3.035 (1.15) + 0.02164 (20.5) - 0.004979 (42) = \underline{3.73 \text{ m}} = \underline{12.2 \text{ ft}}$$

If the proposed pond depth exceeds the estimated photic zone depth of 12.2 ft, aeration or other mixing will be required for areas deeper than 12.2 ft to maintain a well mixed water column. The aeration or mixing must be sufficient to mix the water column to the maximum pond depth. The specific design of the required system should be selected by a qualified aeration specialist.

As an alternative to providing aeration or mixing within the pond, the required permanent pool volume could be considered as only the volume above the anoxic zone and not the entire volume of the pond. Areas below the anoxic depth would be considered as dead storage, although these areas would provide a significant storage volume for collected solids.

If the pond is modified, based on the results of the calculated anoxic zone depth, the calculations would need to be redone to estimate new values for total phosphorus, Secchi disk depth, chlorophyll-a, and depth of anoxia to demonstrate that the new design meets the required permanent pool volume above the zone of anoxia.

7. Estimate pond dimensions

For the estimation of pond dimensions, assume that the mean depth (pond volume/pond area) is 2/3 of the maximum depth.

$$\text{Mean pond depth} = 12.2 \text{ ft} \times 2/3 = 8.13 \text{ ft}$$

$$\text{Pond surface area} = \text{pond volume}/\text{mean depth} = 18.21 \text{ ac-ft}/8.13 \text{ ft} = 2.24 \text{ ac}$$

2C. KEY WEST (ZONE 3) PROJECT

The required dry retention volume is estimated from the tables given in Appendix D using the development characteristics:

DCIA Percentage = 18.75% of developed area

Non-DCIA CN = 81.4

1. Required Dry Retention Depth

From Appendix D (Zone 3), the required removal efficiency of 65.0% is achieved with a dry retention depth between 0.75 and 1.00 inch.

For a dry retention depth of 0.75 inch, the treatment efficiency is obtained by iterating between DCIA percentages of 10 and 20, and for non-DCIA CN values between 80 and 90. The efficiency for the project conditions is 65.0%. There is no need to conduct further iterations since a dry retention depth of 0.75 inch will provide the required removal efficiency of 65.0%.

The dry retention depth required to achieve 65.0% removal is 0.75 inch.

Therefore, the required treatment train will consist of:

- a. 0.75 inch dry retention, followed by
- b. Wet detention pond with a 200-day mean residence time

2. Wet Detention Pond Characteristics

The required physical characteristics of the wet detention pond are determined based on the desired residence time and the impacts of the proposed dry retention pre-treatment.

A. Calculate annual runoff inputs to pond

The annual runoff coefficient for the development can be estimated using the tables included in Appendix C (Zone 3).

For: DCIA = 18.75% and non-DCIA CN = 81.4

The estimated “C” value is obtained by iteration as discussed previously.

Annual C Value = 0.266

The annual rainfall for the Key West area = 40.0 inches (Appendix A.3)

Annual generated runoff volume =

$$90 \text{ acres} \times 40.0 \text{ inches/year} \times 1 \text{ ft/12 inches} \times 0.266 = 79.80 \text{ ac-ft/yr}$$

The calculated efficiency of 65.0% for the dry retention pre-treatment means that 65.0% of the annual runoff volume will be infiltrated into the ground and will not discharge directly into the wet detention pond. The annual runoff volume which reaches the pond is calculated as:

$$\text{Annual Inputs to Pond} = 79.80 \text{ ac-ft/yr} \times (1 - 0.650) = 27.93 \text{ ac-ft/yr}$$

For a 200-day residence time, the pond volume will be:

$$27.93 \text{ ac-ft/yr} \times 1 \text{ year/365 days} \times 200 \text{ days} = 15.30 \text{ ac-ft}$$

B. Estimate maximum allowable pond depth

The maximum allowable pond depth is directly related to the anticipated algal productivity within the pond. Assuming that wet detention ponds are primarily phosphorus-limited ecosystems, the productivity can be estimated based on the mean TP concentration.

1. Estimate runoff characteristics

For a single-family residential land use, the emc for TP in runoff can be obtained from Table 4-16:

$$\text{TP} = 0.327 \text{ mg/l (single-family residential)}$$

2. Calculate TP loading to wet detention pond

After the dry retention pre-treatment, the annual runoff input to the pond = 27.93 ac-ft/yr

TP load to pond =

$$27.93 \text{ ac-ft/yr} \times \frac{43,560 \text{ ft}^2}{\text{ac}} \times \frac{7.48 \text{ gal}}{\text{ft}^3} \times \frac{3.785 \text{ liter}}{\text{gal}} \times \frac{0.327 \text{ mg}}{\text{liter}} \times \frac{1 \text{ kg}}{10^6 \text{ mg}} = 11.26 \text{ kg TP/yr}$$

3. Calculate TP concentration in pond

At the proposed 200-day residence time, the TP removal was previously estimated as 79.9%.

Annual mass of TP remaining in water column =

$$11.26 \text{ kg TP/yr} \times (1 - 0.799) = 2.26 \text{ kg TP/yr}$$

The remaining TP mass will be distributed between the pond volume and the annual outflow:

$$= 15.30 \text{ ac-ft} + 27.93 \text{ ac-ft} = \underline{43.23 \text{ ac-ft}}$$

Mean pond concentration =

$$\frac{2.26 \text{ kg TP}}{\text{yr}} \times \frac{1 \text{ yr}}{43.23 \text{ ac-ft}} \times \frac{1 \text{ ac}}{43,560 \text{ ft}^2} \times \frac{1 \text{ ft}^3}{7.48 \text{ gal}} \\ \times \frac{1 \text{ gal}}{3.785 \text{ liter}} \times \frac{10^6 \text{ mg}}{\text{kg}} = 0.042 \text{ mg TP/liter} = 42 \text{ } \mu\text{g TP/liter}$$

4. Calculate mean chlorophyll-a concentration in pond

The relationship between TP and chlorophyll-a in a Florida waterbody is expressed by the following relationship:

$$\ln(\text{chyl-a}) = 1.058 \ln(\text{TP}) - 0.934 \quad (\text{Eq. 4})$$

where: chyl-a = chlorophyll-a concentration (mg/m^3)
 TP = total P concentration ($\mu\text{g}/\text{l}$)

$$\ln(\text{chyl-a}) = 1.058 \ln(42) - 0.934$$

$$\text{chyl-a} = e^{3.02} = 20.5 \text{ mg}/\text{m}^3$$

5. Calculate mean Secchi disk depth

The relationship between chlorophyll-a and Secchi disk depth in a Florida waterbody is expressed by the following relationship:

$$SD = \frac{24.2386 + [(0.3041)(\text{chyl} - a)]}{(6.0632 + \text{chyl} - a)}$$

where: SD = Secchi disk depth (m)
 chyl-a = chlorophyll-a (mg/m^3)

$$SD = \frac{24.2386 + [(0.3041)(20.5)]}{(6.0632 + 20.5)} = 1.15 \text{ m} = 3.76 \text{ ft}$$

6. Calculate depth of anoxic conditions in pond

Using the relationship expressed in Eq. 5, the depth of anoxic conditions within the pond can be estimated as follows:

$$\text{Depth of } DO < 1 = 3.035 \times \text{Secchi} + 0.02164 (\text{chl-a}) - 0.004979 \times \text{Total P}$$

where:

Depth of DO < 1	=	anoxic depth (m)
Secchi	=	Secchi disk depth (m)
chl-a	=	chlorophyll-a concentration (mg/m ³)
Total P	=	total phosphorus concentration (µg/l)

$$\text{Depth of } DO < 1 = 3.035 (1.15) + 0.02164 (20.5) - 0.004979 (42) = \underline{3.73 \text{ m}} = \underline{12.2 \text{ ft}}$$

If the proposed pond depth exceeds the estimated photic zone depth of 12.2 ft, aeration or other mixing will be required for areas deeper than 12.2 ft to maintain a well mixed water column. The aeration or mixing must be sufficient to mix the water column to the maximum pond depth. The specific design of the required system should be selected by a qualified aeration specialist.

As an alternative to providing aeration or mixing within the pond, the required permanent pool volume could be considered as only the volume above the anoxic zone and not the entire volume of the pond. Areas below the anoxic depth would be considered as dead storage, although these areas would provide a significant storage volume for collected solids.

If the pond is modified, based on the results of the calculated anoxic zone depth, the calculations would need to be redone to estimate new values for total phosphorus, Secchi disk depth, chlorophyll-a, and depth of anoxia to demonstrate that the new design meets the required permanent pool volume above the zone of anoxia.

7. Estimate pond dimensions

For the estimation of pond dimensions, assume that the mean depth (pond volume/pond area) is 2/3 of the maximum depth.

$$\text{Mean pond depth} = 12.2 \text{ ft} \times 2/3 = 8.13 \text{ ft}$$

$$\text{Pond surface area} = \text{pond volume}/\text{mean depth} = 15.30 \text{ ac-ft}/8.13 \text{ ft} = 1.88 \text{ ac}$$

7.2 Design Example #2:

Stormwater Treatment to Meet the 95% (OFW) Pollution Reduction Target Goal

Determine the water quality treatment requirements for a 100-acre proposed single-family residential site. Perform separate calculations for identical projects located in Pensacola (Zone 1), Orlando (Zone 2), and Key West (Zone 3). A summary of pre- and post-development conditions is given below.

Calculate Pre- and Post-Development Conditions

Pre-Development Conditions

1. **Land Use:** 90 acres - mixture of rangeland/forest (fair condition)
10 acres – isolated wetlands
2. **Ground Cover/Soil Types:** Rangeland/Forest – Hydrologic Soil Group (HSG) D
Wetland – hydric soils
3. **Impervious Areas:** 0% impervious, 0% Directly Connected Impervious Area (DCIA)

Post Development Conditions

1. **Land Use:** 90 acres of single-family residential
5 acres of stormwater management systems
5 acres of preserved wetlands
2. **Ground Cover/Soil Types**
 - A. Residential areas will be covered with lawns in good condition
 - B. Soil types will remain HSG D
3. **Impervious/DCIA Areas**
 - A. Residential areas will be 25% impervious, 75% of which will be DCIA
Impervious Area = 25% of site = 90 ac x 0.25 = 22.50 acres
DCIA Area = 22.50 acres x 0.75 = 16.88 acres
DCIA Percentage = (16.88 ac/90.0 ac) x 100 = 18.7% of developed area

4. **Calculate composite non-DCIA curve number from TR-55:**

Curve number for lawns in good condition in HSG D = 80

Areas of lawns = 90 acres total – 22.50 ac impervious area = 67.50 acres pervious area

Impervious area which is not DCIA = 22.50 ac – 16.88 ac = 5.62 ac

Assume a curve number of 98 for impervious areas

Non-DCIA curve number =

$$\frac{67.50 \text{ ac } (80) + 5.62 \text{ ac } (98)}{67.50 \text{ ac} + 5.62 \text{ ac}} = 81.4$$

Calculate Treatment Requirements for 95% Removal (OFW Criteria)

Estimation of treatment requirements assumes that only dry retention and wet detention are capable of approaching the 95% pollutant reduction goal.

1. **Dry Retention**

A. **Pensacola Project (Zone 1)**

The required retention depth to achieve an annual removal efficiency of 95% in Zone 1 is determined from Table 6-4 (Zone 1) based on DCIA percentage and the non-DCIA CN value. For this project:

DCIA Percentage = 18.75% of developed area

Non-DCIA CN = 81.4

The required dry retention depth is obtained by iterating between DCIA percentages of 10 and 20, and for non-DCIA CN values between 80 and 90. The required dry retention depth = 3.66 inches over the developed area.

B. **Orlando Project (Zone 2)**

If the project was located in Orlando, the required dry retention depth would be slightly different due to differences in the distribution of rain events. The required retention depth would be obtained from Table 6-4 (Zone 2) by iterating between DCIA percentages of 10 and 20, and for non-DCIA CN values between 80 and 90. The required dry retention depth = 2.45 inches over the developed area.

C. **Key West Project (Zone 3)**

If the project was located in Key West, the required dry retention depth would be slightly different due to differences in the distribution of rain events. The required retention depth would be obtained from Table 6-4 (Zone 3) by iterating between DCIA percentages of 10 and 20, and for non-DCIA CN values between 80 and 90. The required dry retention depth = 3.62 inches over the developed area.

2. **Wet Detention**

Treatment Train Approach

Calculation of design criteria for a wet detention pond is based on determining the detention time required to achieve the desired pollutant removal efficiency of 95%. For practical purposes, this efficiency is assumed to apply to nitrogen and phosphorus since other pollutants such as BOD and TSS are typically removed at a faster rate than nutrients. However, as discussed in Section 5.2.2, wet detention systems are incapable of providing 95% annual mass load reduction for either nitrogen or phosphorus, even at extended detention times (> 200 days).

Therefore, when wet detention is desired as a treatment option, pre-treatment must be provided to enhance the total system performance efficiency to a minimum of 95% for both total nitrogen and total phosphorus. Since dry retention provides the best pre-treatment in a minimal space, dry retention appears to be the pre-treatment system of choice for this application. There are many combinations of dry retention and wet detention which can provide the desired 95% removal.

Assume that a wet detention pond is designed with a residence time of 100 days.

Anticipated TN removal (Figure 5-11) =

$$Eff = \frac{(43.75 \times t_d)}{(4.38 + t_d)} = \frac{43.75 \times 100}{4.38 + 100} = 41.9\%$$

Anticipated TP removal (Figure 5-10) =

$$Eff = 40.13 + 6.372 \ln(t_d) + 0.213 (\ln t_d)^2 = 40.13 + 6.372 \ln(100) + 0.213 (\ln 100)^2 = 70.5\%$$

Based on the estimated performance efficiency of the wet detention pond, the pond fails to meet the 95% removal criteria for either TN or TP. Therefore, the remaining efficiency is achieved using dry detention. The required efficiency for the dry retention is calculated by Eq. 1 below:

$$\text{Treatment Train Efficiency} = Eff_1 + (1 - Eff_1) \times Eff_2 \quad (\text{Eq. 1})$$

where: Eff_1 = required efficiency of dry retention
 Eff_2 = efficiency of wet detention

For total nitrogen: $0.95 = \text{Eff}_1 + (1 - \text{Eff}_1) \times 0.419$

$$\text{Eff}_1 = 0.947 = 94.7\%$$

For total phosphorus: $0.95 = \text{Eff}_1 + (1 - \text{Eff}_1) \times 0.705$

$$\text{Eff}_1 = 0.831 = 83.1\%$$

The largest removal efficiency of 94.7% is required for total nitrogen. Therefore, this efficiency will dictate the required design for the treatment train.

2A. PENSACOLA (ZONE 1) PROJECT

The required dry retention volume is estimated from the tables given in Appendix D using the development characteristics:

DCIA Percentage = 18.75% of developed area

Non-DCIA CN = 81.4

1. Required Dry Retention Depth

From Appendix D (Zone 1), the required removal efficiency of 94.7% is achieved with a dry retention depth between 3.50 and 3.75 inches.

For a dry retention depth of 3.50 inches, the treatment efficiency is obtained by iterating between DCIA percentages of 10 and 20, and for non-DCIA CN values between 80 and 90. The efficiency for the project conditions is 94.3%.

For a dry retention depth of 3.75 inches, the treatment efficiency is obtained by iterating between DCIA percentages of 10 and 20, and for non-DCIA CN values between 80 and 90. The efficiency for the project conditions is 95.1%.

By iterating between 3.50 inches (94.3%) and 3.75 inches (95.1%), the dry retention depth required to achieve 94.7% removal is 3.72 inches.

Therefore, the required treatment train will consist of:

- a. 3.72 inches dry retention, followed by
- b. Wet detention pond with a 100-day mean residence time

2. Wet Detention Pond Characteristics

The required physical characteristics of the wet detention pond are determined based on the desired residence time and the impacts of the proposed dry retention pre-treatment.

a. Calculate annual runoff inputs to pond

The annual runoff coefficient for the development can be estimated using the tables included in Appendix C (Zone 1).

For: DCIA = 18.75% and non-DCIA CN = 81.4

The estimated “C” value is obtained by iteration as discussed previously.

Annual C Value = 0.304

The annual rainfall for the Pensacola area = 65.5 inches (Appendix A.3)

Annual generated runoff volume =

$$90 \text{ acres} \times 65.5 \text{ inches/year} \times 1 \text{ ft/12 inches} \times 0.304 = 149.34 \text{ ac-ft/yr}$$

The calculated efficiency of 94.7% for the dry retention pre-treatment means that 94.7% of the annual runoff volume will be infiltrated into the ground and will not discharge directly into the wet detention pond. The annual runoff volume which reaches the pond is calculated as:

$$\text{Annual Inputs to Pond} = 149.34 \text{ ac-ft/yr} \times (1 - 0.947) = 7.92 \text{ ac-ft/yr}$$

For a 100-day residence time, the pond volume will be:

$$7.92 \text{ ac-ft/yr} \times 1 \text{ year/365 days} \times 100 \text{ days} = 2.17 \text{ ac-ft}$$

b. Estimate maximum allowable pond depth

The maximum allowable pond depth is directly related to the anticipated algal productivity within the pond. Assuming that wet detention ponds are primarily phosphorus-limited ecosystems, the productivity can be estimated based on the mean TP concentration.

1. Estimate runoff characteristics

For a single-family residential land use, the event mean concentration (emc) for TP in runoff can be obtained from Table 4-17:

$$\text{TP} = 0.327 \text{ mg/l (single-family residential)}$$

2. Calculate TP loading to wet detention pond

After the dry retention pre-treatment, the annual runoff input to the pond = 7.92 ac-ft/yr

TP load to pond =

$$7.92 \text{ ac} \cdot \text{ft/yr} \times \frac{43,560 \text{ ft}^2}{\text{ac}} \times \frac{7.48 \text{ gal}}{\text{ft}^3} \times \frac{3.785 \text{ liter}}{\text{gal}} \times \frac{0.327 \text{ mg}}{\text{liter}} \times \frac{1 \text{ kg}}{10^6 \text{ mg}} = 3.19 \text{ kg TP/yr}$$

3. Calculate TP concentration in pond

At the proposed 100-day residence time, the TP removal was previously estimated as 70.5%.

Annual mass of TP remaining in water column =

$$3.19 \text{ kg TP/yr} \times (1 - 0.705) = 0.94 \text{ kg TP/yr}$$

The remaining TP mass will be distributed between the pond volume and the annual outflow:

$$= 2.17 \text{ ac} \cdot \text{ft} + 7.92 \text{ ac} \cdot \text{ft} = 10.09 \text{ ac} \cdot \text{ft}$$

Mean pond concentration =

$$\frac{0.94 \text{ kg TP}}{\text{yr}} \times \frac{1 \text{ yr}}{10.09 \text{ ac} \cdot \text{ft}} \times \frac{1 \text{ ac}}{43,560 \text{ ft}^2} \times \frac{1 \text{ ft}^3}{7.48 \text{ gal}} \times \frac{1 \text{ gal}}{3.785 \text{ liter}} \times \frac{10^6 \text{ mg}}{\text{kg}} = 0.076 \text{ mg TP/liter} = 76 \text{ } \mu\text{g TP/liter}$$

4. Calculate mean chlorophyll-a concentration in pond

The relationship between TP and chlorophyll-a in a Florida waterbody is expressed by the following relationship:

$$\ln(\text{chl-a}) = 1.058 \ln(\text{TP}) - 0.934 \quad (\text{Eq. 4})$$

where: chl-a = chlorophyll-a concentration (mg/m³)

TP = total P concentration (μg/l)

$$\ln(\text{chl-a}) = 1.058 \ln(76) - 0.934$$

$$\text{chl-a} = e^{3.648} = 38.4 \text{ mg/m}^3$$

5. Calculate mean Secchi disk depth

The relationship between chlorophyll-a and Secchi disk depth in a Florida waterbody is expressed by the following relationship:

$$SD = \frac{24.2386 + [(0.3041)(chyl - a)]}{(6.0632 + chyl - a)}$$

where: SD = Secchi disk depth (m)
 chyl-a = chlorophyll-a (mg/m³)

$$SD = \frac{24.2386 + [(0.3041) (38.4)]}{(6.0632 + 38.4)} = 0.81 \text{ m} = 2.65 \text{ ft}$$

6. Calculate depth of anoxic conditions in pond

Using the relationship expressed in Eq. 5, the depth of anoxic conditions within the pond can be estimated as follows:

$$\text{Depth of } DO < 1 = 3.035 \times \text{Secchi} + 0.02164 \times (\text{chyl-a}) - 0.004979 \times \text{Total P}$$

where:

Depth of DO < 1 = anoxic depth (m)
 Secchi = Secchi disk depth (m)
 chyl-a = chlorophyll-a concentration (mg/m³)
 Total P = total phosphorus concentration (µg/l)

$$\text{Depth of } DO < 1 = 3.035 (0.81) + 0.02164 (38.4) - 0.004979 (72) = \underline{2.93 \text{ m}} = \underline{9.6 \text{ ft}}$$

If the proposed pond depth exceeds the estimated photic zone depth of 9.6 ft, aeration or other mixing will be required for areas deeper than 9.6 ft to maintain a well mixed water column. The aeration or mixing must be sufficient to mix the water column to the maximum pond depth. The specific design of the required system should be selected by a qualified aeration specialist.

As an alternative to providing aeration or mixing within the pond, the required permanent pool volume could be considered as only the volume above the anoxic zone and not the entire volume of the pond. Areas below the anoxic depth would be considered as dead storage, although these areas would provide a significant storage volume for collected solids.

If the pond is modified, based on the results of the calculated anoxic zone depth, the calculations would need to be redone to estimate new values for total phosphorus, Secchi disk depth, chlorophyll-a, and depth of anoxia to demonstrate that the new design meets the required permanent pool volume above the zone of anoxia.

7. Estimate pond dimensions

For the estimation of pond dimensions, assume that the mean depth (pond volume/pond area) is $2/3$ of the maximum depth.

$$\text{Mean pond depth} = 9.6 \text{ ft} \times 2/3 = 6.40 \text{ ft}$$

$$\text{Pond surface area} = \text{pond volume}/\text{mean depth} = 2.17 \text{ ac-ft}/6.40 \text{ ft} = 0.34 \text{ ac}$$

2B. ORLANDO (ZONE 2) PROJECT

The required dry retention volume is estimated from the tables given in Appendix D using the development characteristics:

$$\text{DCIA Percentage} = 18.75\% \text{ of developed area}$$

$$\text{Non-DCIA CN} = 81.4$$

1. Required Dry Retention Depth

From Appendix D (Zone 2), the required removal efficiency of 94.7% is achieved with a dry retention depth between 2.25 and 2.00 inches.

For a dry retention depth of 2.25 inches, the treatment efficiency is obtained by iterating between DCIA percentages of 10 and 20, and for non-DCIA CN values between 80 and 90. The efficiency for the project conditions is 94.8.

For a dry retention depth of 2.00 inches, the treatment efficiency is obtained by iterating between DCIA percentages of 10 and 20, and for non-DCIA CN values between 80 and 90. The efficiency for the project conditions is 92.4.

By iterating between 2.00 inches (92.4%) and 2.25 inches (94.8%), the dry retention depth required to achieve 94.7% removal is 2.24 inches.

Therefore, the required treatment train will consist of:

- a. 2.24 inches dry retention, followed by
- b. Wet detention pond with a 100-day mean residence time

2. Wet Detention Pond Characteristics

The required physical characteristics of the wet detention pond are determined based on the desired residence time and the impacts of the proposed dry retention pre-treatment.

A. Calculate annual runoff inputs to pond

The annual runoff coefficient for the development can be estimated using the tables included in Appendix C (Orlando).

For: DCIA = 18.75% and non-DCIA CN = 81.4

The estimated “C” value is obtained by iteration as discussed previously.

Annual C Value = 0.253

The annual rainfall for the Orlando area = 50.0 inches (Appendix A.3)

Annual generated runoff volume =

$$90 \text{ acres} \times 50.0 \text{ inches/year} \times 1 \text{ ft/12 inches} \times 0.253 = 94.88 \text{ ac-ft/yr}$$

The calculated efficiency of 94.7% for the dry retention pre-treatment means that 94.7% of the annual runoff volume will be infiltrated into the ground and will not discharge directly into the wet detention pond. The annual runoff volume which reaches the pond is calculated as:

$$\text{Annual Inputs to Pond} = 94.88 \text{ ac-ft/yr} \times (1 - 0.947) = 5.03 \text{ ac-ft/yr}$$

For a 100-day residence time, the pond volume will be:

$$5.03 \text{ ac-ft/yr} \times 1 \text{ year/365 days} \times 100 \text{ days} = 1.38 \text{ ac-ft}$$

B. Estimate maximum allowable pond depth

The maximum allowable pond depth is directly related to the anticipated algal productivity within the pond. Assuming that wet detention ponds are primarily phosphorus-limited ecosystems, the productivity can be estimated based on the mean TP concentration.

1. Estimate runoff characteristics

For a single-family residential land use, the emc for TP in runoff can be obtained from Table 4-17:

$$\text{TP} = 0.327 \text{ mg/l (single-family residential)}$$

2. Calculate TP loading to wet detention pond

After the dry retention pre-treatment, the annual runoff input to the pond = 5.03 ac-ft/yr

TP load to pond =

$$5.03 \text{ ac-ft/yr} \times \frac{43,560 \text{ ft}^2}{\text{ac}} \times \frac{7.48 \text{ gal}}{\text{ft}^3} \times \frac{3.785 \text{ liter}}{\text{gal}} \times \frac{0.327 \text{ mg}}{\text{liter}} \times \frac{1 \text{ kg}}{10^6 \text{ mg}} = 2.03 \text{ kg TP/yr}$$

3. Calculate TP concentration in pond

At the proposed 100-day residence time, the TP removal was previously estimated as 70.5%.

Annual mass of TP remaining in water column =

$$2.03 \text{ kg TP/yr} \times (1 - 0.705) = 0.60 \text{ kg TP/yr}$$

The remaining TP mass will be distributed between the pond volume and the annual outflow:

$$= 1.38 \text{ ac-ft} + 5.03 \text{ ac-ft} = 6.41 \text{ ac-ft}$$

Mean pond concentration =

$$\frac{0.60 \text{ kg TP}}{\text{yr}} \times \frac{1 \text{ yr}}{6.41 \text{ ac-ft}} \times \frac{1 \text{ ac}}{43,560 \text{ ft}^2} \times \frac{1 \text{ ft}^3}{7.48 \text{ gal}} \times \frac{1 \text{ gal}}{3.785 \text{ liter}} \times \frac{10^6 \text{ mg}}{\text{kg}} = 0.076 \text{ mg TP/liter} = 76 \text{ } \mu\text{g TP/liter}$$

4. Calculate mean chlorophyll-a concentration in pond

The relationship between TP and chlorophyll-a in a Florida waterbody is expressed by the following relationship:

$$\ln(\text{chl-a}) = 1.058 \ln(\text{TP}) - 0.934 \quad (\text{Eq. 4})$$

where: chl-a = chlorophyll-a concentration (mg/m^3)

TP = total P concentration ($\mu\text{g}/\text{l}$)

$$\ln(\text{chl-a}) = 1.058 \ln(76) - 0.934$$

$$\text{chl-a} = e^{3.65} = 38.4 \text{ mg}/\text{m}^3$$

5. Calculate mean Secchi disk depth

The relationship between chlorophyll-a and Secchi disk depth in a Florida waterbody is expressed by the following relationship:

$$SD = \frac{24.2386 + [(0.3041)(chyl - a)]}{(6.0632 + chyl - a)}$$

where: SD = Secchi disk depth (m)
 chyl-a = chlorophyll-a (mg/m³)

$$SD = \frac{24.2386 + [(0.3041) (38.4)]}{(6.0632 + 38.4)} = 0.81 \text{ m} = 2.65 \text{ ft}$$

6. Calculate depth of anoxic conditions in pond

Using the relationship expressed in Eq. 5, the depth of anoxic conditions within the pond can be estimated as follows:

$$\text{Depth of } DO < 1 = 3.035 \times \text{Secchi} + 0.02164 \times (\text{chyl-a}) - 0.004979 \times \text{Total P}$$

where:

Depth of DO < 1 = anoxic depth (m)
 Secchi = Secchi disk depth (m)
 chyl-a = chlorophyll-a concentration (mg/m³)
 Total P = total phosphorus concentration (µg/l)

$$\text{Depth of } DO < 1 = 3.035 (0.81) + 0.02164 (38.4) - 0.004979 (76) = \underline{2.91 \text{ m}} = \underline{9.5 \text{ ft}}$$

If the proposed pond depth exceeds the estimated photic zone depth of 9.5 ft, aeration or other mixing will be required for areas deeper than 9.5 ft to maintain a well mixed water column. The aeration or mixing must be sufficient to mix the water column to the maximum pond depth. The specific design of the required system should be selected by a qualified aeration specialist.

As an alternative to providing aeration or mixing within the pond, the required permanent pool volume could be considered as only the volume above the anoxic zone and not the entire volume of the pond. Areas below the anoxic depth would be considered as dead storage, although these areas would provide a significant storage volume for collected solids.

If the pond is modified, based on the results of the calculated anoxic zone depth, the calculations would need to be redone to estimate new values for total phosphorus, Secchi disk depth, chlorophyll-a, and depth of anoxia to demonstrate that the new design meets the required permanent pool volume above the zone of anoxia.

7. Estimate pond dimensions

For the estimation of pond dimensions, assume that the mean depth (pond volume/pond area) is $2/3$ of the maximum depth.

$$\text{Mean pond depth} = 9.5 \text{ ft} \times 2/3 = 6.36 \text{ ft}$$

$$\text{Pond surface area} = \text{pond volume}/\text{mean depth} = 1.38 \text{ ac-ft}/6.36 \text{ ft} = 0.22 \text{ ac}$$

2C. KEY WEST (ZONE 3) PROJECT

The required dry retention volume is estimated from the tables given in Appendix D using the development characteristics:

$$\text{DCIA Percentage} = 18.75\% \text{ of developed area}$$

$$\text{Non-DCIA CN} = 81.4$$

1. Required Dry Retention Depth

From Appendix D (Zone 3), the required removal efficiency of 94.7% is achieved with a dry retention depth in excess of 4 inches.

For a dry retention depth of 4.00 inches, the treatment efficiency is obtained by iterating between DCIA percentages of 10 and 20, and for non-DCIA CN values between 80 and 90. The efficiency for the project conditions is 93.8%.

The maximum retention depth of 4 inches listed in Appendix D fails to reach the required removal efficiency of 94.7% for the retention portion of the treatment train. Since increasing the detention time of the wet detention pond will not significantly enhance the efficiency of the system, it is not possible to achieve the goal of 95% pollutant removal for both total nitrogen and total phosphorus for Zone 3 conditions without involving unreasonable dry retention requirements.

7.3 Design Example #3:

Stormwater Treatment to Meet the Post- Less Than or Equal to Pre-Pollution Reduction Target Goal

Determine the water quality treatment requirements for a 100-acre proposed single-family residential site. Perform separate calculations for identical projects located in Pensacola (Zone 1), Orlando (Zone 2), and Key West (Zone 3). A summary of pre- and post-development conditions is given below.

Calculate Pre- and Post-Development Conditions

Pre-Development Conditions

1. **Land Use:** 90 acres - mixture of rangeland/forest (fair condition)
10 acres – isolated hardwood wetlands
2. **Ground Cover/Soil Types:** Rangeland/Forest – Hydrologic Soil Group (HSG) D
Wetland – hydric soils
3. **Impervious Areas:** 0% impervious, 0% Directly Connected Impervious Area (DCIA)
4. **Estimation of Pre-Development Loadings:** The total project site covers 100 acres, including 90 acres of rangeland/forest and 10 acres of wetlands. Five acres of the on-site wetlands will be preserved and 5 acres will be incorporated into the project.

A. Pre-Development Runoff Volume

- (1) **Rangeland/Forest:** From TR-55, the CN for rangeland (fair condition) in HSG D soils is 84 and the CN for forest areas (woods) is 82. Assuming a 50-50 mixture of rangeland and forest, the composite CN is:

$$\text{Composite CN} = 84 (\text{rangeland}) \times 0.5 + 82 (\text{forest}) \times 0.5 = 83$$

From Appendix C, the annual runoff coefficient for DCIA = 0 and CN = 83 can be estimated by interpolation:

Pensacola (Zone 1)	=	0.197
Orlando (Zone 2)	=	0.140
Key West (Zone 3)	=	0.159

From Appendix A.3, the annual rainfall depths for the 3 sites are:

Pensacola	=	65.5 in/yr
Orlando	=	50.0 in/yr
Key West	=	40.0 in/yr

Annual runoff volumes for the 3 sites are:

Pensacola:

$$90 \text{ acres} \times 65.5 \text{ in/yr} \times 1 \text{ ft/12 in} \times 0.197 = \underline{96.78 \text{ ac-ft/yr}}$$

Orlando:

$$90 \text{ acres} \times 50.0 \text{ in/yr} \times 1 \text{ ft/12 in} \times 0.140 = \underline{52.5 \text{ ac-ft/yr}}$$

Key West:

$$90 \text{ acres} \times 40.0 \text{ in/yr} \times 1 \text{ ft/12 in} \times 0.159 = \underline{47.7 \text{ ac-ft/yr}}$$

- (2) **Isolated Hardwood Wetland:** From TR-55, the CN for wooded areas (fair condition) in hydric soils (HSG D) is 82.

From Appendix C, the annual runoff coefficient for DCIA = 0 and CN = 82 can be estimated by interpolation:

Pensacola (Zone 1)	=	0.185
Orlando (Zone 2)	=	0.142
Key West (Zone 3)	=	0.159

Based on a review of the site conditions (including wetland indicators and water level data) by the project biologist and engineer, it was determined that approximately 75% of the generated runoff volume is retained in the wetland and 25% leaves the wetland as runoff. Of the 10 acres of on-site wetlands, 5 acres will be preserved and 5 acres will be incorporated into the development. Calculations are conducted only for the 5 acres to be altered, since the remaining 5 acres will have the same loading characteristics under pre- and post-conditions.

Annual runoff export from the 5-acre wetland areas are:

Pensacola:

$$5 \text{ acres} \times 65.5 \text{ in/yr} \times 1 \text{ ft/12 in} \times 0.185 \times 0.25 = \underline{1.26 \text{ ac-ft}}$$

Orlando:

$$5 \text{ acres} \times 50.0 \text{ in/yr} \times 1 \text{ ft/12 in} \times 0.131 \times 0.25 = \underline{0.68 \text{ ac-ft}}$$

Key West:

$$5 \text{ acres} \times 40.0 \text{ in/yr} \times 1 \text{ ft/12 in} \times 0.149 \times 0.25 = \underline{0.62 \text{ ac-ft}}$$

B. Total Nitrogen

- (1) **Rangeland/Forest:** The typical TN concentration for undeveloped land (rangeland-forest) = 1.15 mg/l (Table 4-17)

Pensacola: Annual TN Load =

$$\frac{96.78 \text{ ac-ft}}{\text{yr}} \times \frac{43,560 \text{ ft}^2}{\text{ac}} \times \frac{7.48 \text{ gal}}{\text{ft}^3} \times \frac{3.785 \text{ liter}}{\text{gal}} \times \frac{1.15 \text{ mg TN}}{\text{liter}} \times \frac{1 \text{ kg}}{10^6 \text{ mg}} = \underline{137.3 \text{ kg TN/yr}}$$

Orlando: Annual TN Load =

$$\frac{52.5 \text{ ac-ft}}{\text{yr}} \times \frac{43,560 \text{ ft}^2}{\text{ac}} \times \frac{7.48 \text{ gal}}{\text{ft}^3} \times \frac{3.785 \text{ liter}}{\text{gal}} \times \frac{1.15 \text{ mg TN}}{\text{liter}} \times \frac{1 \text{ kg}}{10^6 \text{ mg}} = \underline{74.5 \text{ kg TN/yr}}$$

Key West: Annual TN Load =

$$\frac{47.7 \text{ ac-ft}}{\text{yr}} \times \frac{43,560 \text{ ft}^2}{\text{ac}} \times \frac{7.48 \text{ gal}}{\text{ft}^3} \times \frac{3.785 \text{ liter}}{\text{gal}} \times \frac{1.15 \text{ mg TN}}{\text{liter}} \times \frac{1 \text{ kg}}{10^6 \text{ mg}} = \underline{67.7 \text{ kg TN/yr}}$$

- (2) **Hardwood Wetland:** Water quality monitoring was conducted in the hardwood wetland to establish ambient water quality characteristics. This monitoring resulted in a mean TN concentration of 2.0 mg/l for TN.

Pensacola: Annual TN Load =

$$1.26 \text{ ac-ft} \times \frac{43,560 \text{ ft}^2}{\text{ac}} \times \frac{7.48 \text{ gal}}{\text{ft}^3} \times \frac{3.785 \text{ liter}}{\text{gal}} \times \frac{2.00 \text{ mg TN}}{\text{liter}} \times \frac{1 \text{ kg}}{10^6 \text{ mg}} = \underline{3.11 \text{ kg TN/yr}}$$

Orlando: Annual TN Load =

$$0.68 \text{ ac-ft} \times \frac{43,560 \text{ ft}^2}{\text{ac}} \times \frac{7.48 \text{ gal}}{\text{ft}^3} \times \frac{3.785 \text{ liter}}{\text{gal}} \times \frac{2.00 \text{ mg TN}}{\text{liter}} \times \frac{1 \text{ kg}}{10^6 \text{ mg}} = \underline{1.68 \text{ kg TN/yr}}$$

Key West: Annual TN Load =

$$0.62 \text{ ac-ft} \times \frac{43,560 \text{ ft}^2}{\text{ac}} \times \frac{7.48 \text{ gal}}{\text{ft}^3} \times \frac{3.785 \text{ liter}}{\text{gal}} \times \frac{2.00 \text{ mg TN}}{\text{liter}} \times \frac{1 \text{ kg}}{10^6 \text{ mg}} = \underline{1.53 \text{ kg TN/yr}}$$

- (3) **Total TN Loadings:** The total pre-development TN loadings are equal to the sum of the loadings from the rangeland/forests and hardwood wetland areas:

Pensacola: 137.3 kg TN/yr + 3.11 kg TN/yr = 140.41 kg TN/yr

Orlando: 74.5 kg TN/yr + 1.68 kg TN/yr = 76.18 kg TN/yr

Key West: 67.7 kg TN/yr + 1.53 kg TN/yr = 69.23 kg TN/yr

- C. **Total Phosphorus:** For HSG D conditions, the natural/undeveloped areal phosphorus loadings vary by meteorological area within the State

- (1) **Rangeland/Forest:** The typical TP concentration for undeveloped land = 0.055 mg/l

Pensacola: Annual TP Load =

$$\frac{96.78 \text{ ac-ft}}{\text{yr}} \times \frac{43,560 \text{ ft}^2}{\text{ac}} \times \frac{7.48 \text{ gal}}{\text{ft}^3} \times \frac{3.785 \text{ liter}}{\text{gal}} \times \frac{0.055 \text{ mg TP}}{\text{Liter}} \times \frac{1 \text{ kg}}{10^6 \text{ mg}} = \underline{6.57 \text{ kg TP/yr}}$$

Orlando: Annual TP Load =

$$\frac{52.5 \text{ ac-ft}}{\text{yr}} \times \frac{43,560 \text{ ft}^2}{\text{ac}} \times \frac{7.48 \text{ gal}}{\text{ft}^3} \times \frac{3.785 \text{ liter}}{\text{gal}} \times \frac{0.055 \text{ mg TP}}{\text{Liter}} \times \frac{1 \text{ kg}}{10^6 \text{ mg}} = \underline{3.56 \text{ kg TP/yr}}$$

Key West: Annual TP Load =

$$\frac{47.7 \text{ ac-ft}}{\text{yr}} \times \frac{43,560 \text{ ft}^2}{\text{ac}} \times \frac{7.48 \text{ gal}}{\text{ft}^3} \times \frac{3.785 \text{ liter}}{\text{gal}} \times \frac{0.055 \text{ mg TP}}{\text{liter}} \times \frac{1 \text{ kg}}{10^6 \text{ mg}} = \underline{3.24 \text{ kg TP/yr}}$$

- (2) **Hardwood Wetland:** Water quality monitoring was conducted in the hardwood wetland to establish ambient water quality characteristics. This monitoring resulted in a mean TP concentration of 0.066 mg/l.

Pensacola: Annual TP Load =

$$1.26 \text{ ac-ft} \times \frac{43,560 \text{ ft}^2}{\text{ac}} \times \frac{7.48 \text{ gal}}{\text{ft}^3} \times \frac{3.785 \text{ liter}}{\text{gal}} \times \frac{0.066 \text{ mg TP}}{\text{Liter}} \times \frac{1 \text{ kg}}{10^6 \text{ mg}} = \underline{0.10 \text{ kg TP/yr}}$$

Orlando: Annual TP Load =

$$0.68 \text{ ac-ft} \times \frac{43,560 \text{ ft}^2}{\text{ac}} \times \frac{7.48 \text{ gal}}{\text{ft}^3} \times \frac{3.785 \text{ liter}}{\text{gal}} \times \frac{0.066 \text{ mg TP}}{\text{Liter}} \times \frac{1 \text{ kg}}{10^6 \text{ mg}} = \underline{0.055 \text{ kg TP/yr}}$$

Key West: Annual TP Load =

$$0.62 \text{ ac-ft} \times \frac{43,560 \text{ ft}^2}{\text{ac}} \times \frac{7.48 \text{ gal}}{\text{ft}^3} \times \frac{3.785 \text{ liter}}{\text{gal}} \times \frac{0.066 \text{ mg TP}}{\text{liter}} \times \frac{1 \text{ kg}}{10^6 \text{ mg}} = \underline{0.05 \text{ kg TP/yr}}$$

- (3) **Total TP Loadings:** The total pre-development TP loadings are equal to the sum of the loadings from the rangeland/forests and hardwood wetland areas:

Pensacola: 6.57 kg TP/yr + 0.066 kg TP/yr = 6.64 kg TP/yr

Orlando: 3.56 kg TP/yr + 0.055 kg TP/yr = 3.62 kg TP/yr

Key West: 3.24 kg TP/yr + 0.05 kg TP/yr = 3.29 kg TP/yr

Post Development Conditions

1. **Land Use:** 90 acres of single-family residential
5 acres of stormwater management systems
5 acres of preserved wetlands
2. **Ground Cover/Soil Types**
 - A. Residential areas will be covered with lawns in good condition
 - B. Soil types will remain HSG D

3. **Impervious/DCIA Areas**

A. Residential areas will be 25% impervious, 75% of which will be DCIA

$$\text{Impervious Area} = 25\% \text{ of site} = 90 \text{ ac} \times 0.25 = 22.50 \text{ acres}$$

$$\text{DCIA Area} = 22.50 \text{ acres} \times 0.75 = 16.88 \text{ acres}$$

$$\text{DCIA Percentage} = (16.88 \text{ ac}/90.0 \text{ ac}) \times 100 = 18.7\% \text{ of developed area}$$

4. **Calculate composite non-DCIA curve number from TR-55:**

Curve number for lawns in good condition in HSG D = 80

Areas of lawns = 90 acres total – 22.50 ac impervious area = 67.50 acres pervious area

Impervious area which is not DCIA = 22.50 ac – 16.88 ac = 5.62 ac

Assume a curve number of 98 for impervious areas

Non-DCIA curve number =

$$\frac{67.50 \text{ ac} (80) + 5.62 \text{ ac} (98)}{67.50 \text{ ac} + 5.62 \text{ ac}} = 81.4$$

5. **Calculate annual runoff volume for developed area:** The proposed developed area for the project is 90 ac. Estimation of runoff volumes is not included for the 5-acre stormwater management area since runoff generated in these areas is incorporated into the performance efficiency estimates for the stormwater system. Also, runoff volumes are not calculated for the 5-acre wetland tract which is to be preserved.

a. **Pensacola (Zone 1) Project:** From the tables included in Appendix C (Zone 1), the annual runoff coefficient is estimated for a project site with 18.75% DCIA and non-DCIA CN = 81.4

$$\text{Annual C value} = 0.304$$

The annual rainfall for the Pensacola area = 65.5 inches (Appendix A.3)

$$\text{Annual generated runoff volume} = 90 \text{ ac} \times 65.5 \text{ in/yr} \times 1 \text{ ft}/12 \text{ in} \times 0.304 = \underline{149.3 \text{ ac-ft/yr}}$$

b. **Orlando (Zone 2) Project:** From the tables included in Appendix C (Zone 2), the annual runoff coefficient is estimated for a project site with 18.75% DCIA and non-DCIA CN = 81.4

Annual C value = 0.253

The annual rainfall for the Orlando area = 50.0 inches (Appendix A.3)

Annual generated runoff volume = $90 \text{ ac} \times 50.0 \text{ in/yr} \times 1 \text{ ft/12 in} \times 0.253 = \underline{94.8 \text{ ac-ft/yr}}$

- c. **Key West (Zone 3) Project:** From the tables included in Appendix C (Zone 3), the annual runoff coefficient is estimated for a project site with 18.75% DCIA and non-DCIA CN = 81.4

Annual C value = 0.234

The annual rainfall for the Key West area = 40.0 inches (Appendix A.3)

Annual generated runoff volume = $90 \text{ ac} \times 40.0 \text{ in/yr} \times 1 \text{ ft/12 in} \times 0.234 = \underline{70.2 \text{ ac-ft/yr}}$

6. **Calculate post-development loading prior to stormwater treatment:** Under post-development conditions, nutrient loadings will be generated from the 90-acre developed single-family area. The 5-acre preserved wetland area is not included since the area has the same loadings under pre- and post-conditions.

Stormwater management systems are not included in estimates of post-development loadings since incidental mass inputs of pollutants to these systems are included in the estimation of removal effectiveness.

From Table 4-17, mean emc values for total nitrogen and total phosphorus in single-family residential runoff are:

$$\underline{\text{TN} = 2.07 \text{ mg/l}}$$

$$\underline{\text{TP} = 0.327 \text{ mg/l}}$$

- a. **Pensacola (Zone 1) Project**

- (1) **TN load from single-family area:**

$$\frac{149.3 \text{ ac} \cdot \text{ft}}{\text{yr}} \times \frac{43,560 \text{ ft}^2}{\text{ac}} \times \frac{7.48 \text{ gal}}{\text{ft}^3} \times \frac{3.785 \text{ liter}}{\text{gal}} \times \frac{2.07 \text{ mg}}{\text{liter}} \times \frac{1 \text{ kg}}{10^6 \text{ mg}} = 381 \text{ kg TN/yr}$$

(2) TP load from single-family area

$$\frac{149.3 \text{ ac} \cdot \text{ft}}{\text{yr}} \times \frac{43,560 \text{ ft}^2}{\text{ac}} \times \frac{7.48 \text{ gal}}{\text{ft}^3} \times \frac{3.785 \text{ liter}}{\text{gal}} \times \frac{0.327 \text{ mg}}{\text{liter}} \times \frac{1 \text{ kg}}{10^6 \text{ mg}} = 60.2 \text{ kg TP/yr}$$

b. Orlando (Zone 2) Project**(1) TN load from single-family area**

$$\frac{94.8 \text{ ac} \cdot \text{ft}}{\text{yr}} \times \frac{43,560 \text{ ft}^2}{\text{ac}} \times \frac{7.48 \text{ gal}}{\text{ft}^3} \times \frac{3.785 \text{ liter}}{\text{gal}} \times \frac{2.07 \text{ mg}}{\text{liter}} \times \frac{1 \text{ kg}}{10^6 \text{ mg}} = 242.0 \text{ kg TN/yr}$$

(2) TP load from single-family area

$$\frac{94.8 \text{ ac} \cdot \text{ft}}{\text{yr}} \times \frac{43,560 \text{ ft}^2}{\text{ac}} \times \frac{7.48 \text{ gal}}{\text{ft}^3} \times \frac{3.785 \text{ liter}}{\text{gal}} \times \frac{0.327 \text{ mg}}{\text{liter}} \times \frac{1 \text{ kg}}{10^6 \text{ mg}} = 38.2 \text{ kg TP/yr}$$

c. Key West (Zone 3) Project**(1) TN load from single-family area**

$$\frac{70.2 \text{ ac} \cdot \text{ft}}{\text{yr}} \times \frac{43,560 \text{ ft}^2}{\text{ac}} \times \frac{7.48 \text{ gal}}{\text{ft}^3} \times \frac{3.785 \text{ liter}}{\text{gal}} \times \frac{2.07 \text{ mg}}{\text{liter}} \times \frac{1 \text{ kg}}{10^6 \text{ mg}} = 179.2 \text{ kg TN/yr}$$

(2) TP load from single-family area

$$\frac{70.2 \text{ ac} \cdot \text{ft}}{\text{yr}} \times \frac{43,560 \text{ ft}^2}{\text{ac}} \times \frac{7.48 \text{ gal}}{\text{ft}^3} \times \frac{3.785 \text{ liter}}{\text{gal}} \times \frac{0.327 \text{ mg}}{\text{liter}} \times \frac{1 \text{ kg}}{10^6 \text{ mg}} = 28.3 \text{ kg TP/yr}$$

7. **Calculate required removal efficiencies to achieve post- less than or equal to pre-loadings for TN and TP:** A summary of pre- and post-loadings and required removal efficiencies is given in the following table:

PROJECT LOCATION	TOTAL NITROGEN			TOTAL PHOSPHORUS		
	Pre-Load (kg/yr)	Post-Load (kg/yr)	Required Removal (%)	Pre-Load (kg/yr)	Post-Load (kg/yr)	Required Removal (%)
Pensacola (Zone 1)	140.4	381	63.2	6.64	60.2	89.0
Orlando (Zone 2)	76.2	242	68.5	3.62	38.2	90.5
Key West (Zone 3)	69.2	179.2	61.4	3.29	28.3	88.4

Calculate Treatment Requirements for Post- Less Than or Equal to Pre-Loadings

Estimation of treatment requirements assumes that only dry retention and wet detention are capable of approaching the desired pollutant reduction goal.

1. **Dry Retention:** For dry retention, the removal efficiencies for TN and TP are identical since the removal efficiency is based on the portion of the annual runoff volume which is infiltrated. The required removal is the larger of the calculated removal efficiencies for TN and TP.
 - A. **Pensacola Project:** For the Pensacola area, the annual load reduction is 63.2% for total nitrogen and 89.0% for total phosphorus. The design criteria is based on the largest required removal which is 89.0%. The required retention depth to achieve an annual removal efficiency of 89.0% in the Pensacola area is determined from Appendix D (Zone 1) based on DCIA percentage and the non-DCIA CN value. For this project:

DCIA Percentage = 18.75% of developed area

Non-DCIA CN = 81.4

From Appendix D (Zone 1), the required removal efficiency of 89.0% is achieved with a dry retention depth between 2.50 and 2.75 inches.

For a dry retention depth of 2.50 inches, the treatment efficiency is obtained by iterating between DCIA percentages of 10 and 20, and for non-DCIA CN values between 80 and 90. The efficiency for the project conditions is 88.9%.

For a dry retention depth of 2.75 inches, the treatment efficiency is obtained by iterating between DCIA percentages of 10 and 20, and for non-DCIA CN values between 80 and 90. The efficiency for the project conditions is 91.0%.

By iterating between 2.50 inches (88.9%) and 2.75 inches (91.0%), the dry retention depth required to achieve 89.0% removal is 2.51 inches.

- B. Orlando Project:** For the Orlando area, the annual load reduction is 68.5% for total nitrogen and 90.5% for total phosphorus. The design criteria is based on the largest required removal which is 90.5%. If the project was located in Orlando, the required dry retention depth would be slightly different due to differences in the distribution of rain events. The required retention depth would be obtained from Appendix D (Zone 2) by iterating between DCIA percentages of 10 and 20, and for non-DCIA CN values between 80 and 90.

From Appendix D (Zone 2), the required removal efficiency of 86.8% is achieved with a dry retention depth between 1.50 and 1.75 inches.

For a dry retention depth of 1.75 inches, the treatment efficiency is obtained by iterating between DCIA percentages of 10 and 20, and for non-DCIA CN values between 80 and 90. The efficiency for the project conditions is 91.25%.

For a dry retention depth of 1.50 inch, the treatment efficiency is obtained by iterating between DCIA percentages of 10 and 20, and for non-DCIA CN values between 80 and 90. The efficiency for the project conditions is 88.9%.

By iterating between 1.50 inch (88.9%) and 1.75 inches (91.25%), the dry retention depth required to achieve 91.0% removal is 1.72 inches.

- C. Key West Project:** For the Key West area, the annual load reduction is 61.4% for total nitrogen and 88.4% for total phosphorus. The design criteria is based on the largest required removal which is 88.4%. If the project was located in Key West, the required dry retention depth would be slightly different due to differences in the distribution of rain events. The required retention depth would be obtained from Appendix D (Zone 3) by iterating between DCIA percentages of 10 and 20, and for non-DCIA CN values between 80 and 90.

From Appendix D (Zone 3), the required removal efficiency of 88.4% is achieved with a dry retention depth between 2.50 and 2.75 inches.

For a dry retention depth of 2.75 inches, the treatment efficiency is obtained by iterating between DCIA percentages of 10 and 20, and for non-DCIA CN values between 80 and 90. The efficiency for the project conditions is 88.55%.

For a dry retention depth of 2.50 inches, the treatment efficiency is obtained by iterating between DCIA percentages of 10 and 20, and for non-DCIA CN values between 80 and 90. The efficiency for the project conditions is 87.61%.

By iterating between 2.50 inches (87.6%) and 2.75 inches (88.55%), the dry retention depth required to achieve 88.4% removal is 2.71 inches.

2. Wet Detention

Treatment Train Approach

Calculation of design criteria for a wet detention pond is based on determining the detention time required to achieve the post- ≤ pre-pollutant removal efficiencies for TN and TP listed previously. For practical purposes, this efficiency is assumed to apply to nitrogen and phosphorus since other pollutants such as BOD and TSS are typically removed at a faster rate than nutrients. As discussed in Section 5.2.2, wet detention systems are capable of providing annual mass load reductions for phosphorus in excess of 80% at extended detention times (> 200 days), but the removal efficiency for total nitrogen in wet detention ponds appears to peak at approximately 45%. As a result, wet detention alone is not capable of achieving the required efficiencies of 88.4-90.5% for TP and 61.4-68.5% for TN.

Therefore, when wet detention is desired as a treatment option, pre-treatment must be provided to enhance the total system performance efficiency to the minimum efficiencies necessary to achieve post- ≤ pre-loadings for TN and TP. Since dry retention provides the best pre-treatment in a minimal space, dry retention appears to be the pre-treatment system of choice for this application. There are many combinations of dry retention and wet detention which can provide the desired removals.

Assume that the primary component in the treatment train will be a wet detention pond with a residence time of 150 days.

Anticipated TN removal (Figure 5-10) =

$$Eff = \frac{(43.75 \times t_d)}{(4.38 + t_d)} = \frac{44.72 \times 150}{5.46 + 150} = 42.5\%$$

Anticipated TP removal (Figure 5-9) =

$$Eff = 40.13 + 6.372 \ln(t_d) + 0.213 (\ln t_d)^2 = 40.13 + 6.372 \ln(150) + 0.213 (\ln 150)^2 = 77.4\%$$

2A. PENSACOLA (ZONE 1) PROJECT

Since a wet detention pond cannot meet both the 89.0% removal criteria for TP and the 63.2% removal for TN, the remaining efficiency is achieved using dry retention. The design of the dry retention pond is dictated by the required removal for TN since this is where the largest deficit exists between the required removal and the removal provided by the wet detention pond. The required efficiency for the dry retention is calculated by Eq. 1 below:

$$Treatment\ Train\ Efficiency = Eff_1 + (1 - Eff_1) \times Eff_2 \quad (Eq. 1)$$

where: Eff_1 = required efficiency of dry retention
 Eff_2 = efficiency of wet detention (42.5% for TN)

$$\text{Overall Eff.} = 0.632 = Eff_1 + (1 - Eff_1) \times 0.425$$

$$Eff_1 = 0.360 = 36.0\%$$

The required dry retention volume is estimated from the tables given in Appendix D using the development characteristics:

DCIA Percentage = 18.75% of developed area

Non-DCIA CN = 81.4

1. Required Dry Retention Depth

From Appendix D (Zone 1), the required removal efficiency of 36.0% is achieved with a dry retention depth between 0.00 and 0.25 inch.

For a dry retention depth of 0.25 inch, the treatment efficiency is obtained by iterating between DCIA percentages of 10 and 20, and for non-DCIA CN values between 80 and 90. The efficiency for the project conditions is 38.0%.

By iterating between 0.25 inch (38.0%) and 0.00 inch (0.00%), the dry retention depth required to achieve 36.0% removal is 0.24 inch.

Therefore, the required treatment train will consist of:

- a. 0.24 inch dry retention, followed by
- b. Wet detention pond with a 150-day mean residence time

Based on the relationships given in Figures 5-9 and 5-10, the removal efficiencies for TN and TP increase little at detention times in excess of 100-150 days. Although the pond size may be increased (if desired) for fill or other purposes, the required dry retention pre-treatment depth will not be significantly reduced. However, if the pond residence time is decreased below 150 days, then the dry retention pre-treatment depth will increase correspondingly.

2. Wet Detention Pond Characteristics

The required physical characteristics of the wet detention pond are determined based on the desired residence time and the impacts of the proposed dry retention pre-treatment.

a. Calculate annual runoff inputs to pond

The annual runoff coefficient for the development can be estimated using the tables included in Appendix C (Zone 1).

For: DCIA = 18.75% and non-DCIA CN = 81.4

The estimated "C" value is obtained by iteration as discussed previously.

Annual C Value = 0.304

The annual rainfall for the Pensacola area = 65.5 inches (Appendix A.3)

Annual generated runoff volume =

$$90 \text{ acres} \times 65.5 \text{ inches/year} \times 1 \text{ ft}/12 \text{ inches} \times 0.304 = 149.3 \text{ ac-ft/yr}$$

The calculated efficiency of 36.0% for the dry retention pre-treatment means that 36.0% of the annual runoff volume will be infiltrated into the ground and will not discharge directly into the wet detention pond. The annual runoff volume which reaches the pond is calculated as:

$$\text{Annual Inputs to Pond} = 149.3 \text{ ac-ft/yr} \times (1 - 0.360) = 95.55 \text{ ac-ft/yr}$$

For a 150-day residence time, the pond volume will be:

$$95.55 \text{ ac-ft/yr} \times 1 \text{ year}/365 \text{ days} \times 150 \text{ days} = 39.27 \text{ ac-ft}$$

b. Estimate maximum allowable pond depth

The maximum allowable pond depth is directly related to the anticipated algal productivity within the pond. Assuming that wet detention ponds are primarily phosphorus-limited ecosystems, the productivity can be estimated based on the mean TP concentration.

1. Estimate runoff characteristics

For a single-family residential land use, the event mean concentration (emc) for TP in runoff can be obtained from Table 4-16:

$$\text{TP} = 0.327 \text{ mg/l (single-family residential)}$$

2. Calculate TP loading to wet detention pond

After the dry retention pre-treatment, the annual runoff input to the pond = 95.55 ac-ft/yr

TP load to pond =

$$95.55 \text{ ac-ft/yr} \times \frac{43,560 \text{ ft}^2}{\text{ac}} \times \frac{7.48 \text{ gal}}{\text{ft}^3} \times \frac{3.785 \text{ liter}}{\text{gal}} \times \frac{0.327 \text{ mg}}{\text{liter}} \times \frac{1 \text{ kg}}{10^6 \text{ mg}} = 38.53 \text{ kg TP/yr}$$

3. Calculate TP concentration in pond

At the proposed 150-day residence time, the TP removal was previously estimated as 77.4%.

Annual mass of TP remaining in water column =

$$38.53 \text{ kg TP/yr} \times (1 - 0.774) = 8.71 \text{ kg TP/yr}$$

This mass will be distributed within the pond permanent pool volume (39.27 ac-ft) and the pond outflow. Assuming that inflow and outflow are approximately equal, the outflow volume is 95.55 ac-ft.

Mean pond concentration =

$$\frac{8.71 \text{ kg TP}}{\text{yr}} \times \frac{1 \text{ yr}}{95.55 + 39.27 \text{ ac-ft}} \times \frac{1 \text{ ac}}{43,560 \text{ ft}^2} \times \frac{1 \text{ ft}^3}{7.48 \text{ gal}} \\ \times \frac{1 \text{ gal}}{3.785 \text{ liter}} \times \frac{10^6 \text{ mg}}{\text{kg}} = 0.052 \text{ mg TP/liter} = 52 \text{ } \mu\text{g TP/liter}$$

4. Calculate mean chlorophyll-a concentration in pond

The relationship between TP and chlorophyll-a in a Florida waterbody is expressed by the following relationship:

$$\ln(\text{chyl-a}) = 1.058 \ln(\text{TP}) - 0.934 \quad (\text{Eq. 4})$$

where: chyl-a = chlorophyll-a concentration (mg/m^3)

TP = total P concentration ($\mu\text{g/l}$)

$$\ln(\text{chyl-a}) = 1.058 \ln(52) - 0.934$$

$$\text{chyl-a} = e^{3.25} = 25.7 \text{ mg/m}^3$$

5. Calculate mean Secchi disk depth

The relationship between chlorophyll-a and Secchi disk depth in a Florida waterbody is expressed by the following relationship:

$$SD = \frac{24.2386 + [(0.3041)(\text{chyl} - a)]}{(6.0632 + \text{chyl} - a)}$$

where: SD = Secchi disk depth (m)
 chl-a = chlorophyll-a (mg/m³)

$$SD = \frac{24.2386 + [(0.3041)(25.7)]}{(6.0632 + 25.7)} = 1.01 \text{ m} = 3.31 \text{ ft}$$

6. Calculate depth of anoxic conditions in pond

Using the relationship expressed in Eq. 5, the depth of anoxic conditions within the pond can be estimated as follows:

$$\text{Depth of } DO < 1 = 3.035 \times \text{Secchi} + 0.02164 \times (\text{chl-a}) - 0.004979 \times \text{Total P}$$

where:

Depth of DO < 1 = anoxic depth (m)
 Secchi = Secchi disk depth (m)
 chl-a = chlorophyll-a concentration (mg/m³)
 Total P = total phosphorus concentration (µg/l)

$$\text{Depth of } DO < 1 = 3.035 (1.01) + 0.02164 (25.7) - 0.004979 (52) = \underline{3.37 \text{ m}} = \underline{11.1 \text{ ft}}$$

If the proposed pond depth exceeds the estimated anoxic zone depth of 11.1 ft, aeration or other mixing will be required for areas deeper than 11.1 ft to maintain a well mixed water column. The aeration or mixing must be sufficient to mix the water column to the maximum pond depth. The specific design of the required system should be selected by a qualified aeration specialist.

As an alternative to providing aeration or mixing within the pond, the required permanent pool volume could be considered as only the volume above the anoxic zone and not the entire volume of the pond. Areas below the anoxic depth would be considered as dead storage, although these areas would provide a significant storage volume for collected solids.

If the pond is modified, based on the results of the calculated anoxic zone depth, the calculations would need to be redone to estimate new values for total phosphorus, Secchi disk depth, chlorophyll-a, and depth of anoxia to demonstrate that the new design meets the required permanent pool volume above the zone of anoxia.

7. Estimate pond dimensions

For the estimation of pond dimensions, assume that the mean depth (pond volume/pond area) is $2/3$ of the maximum depth.

$$\text{Mean pond depth} = 11.1 \text{ ft} \times 2/3 = 7.4 \text{ ft}$$

$$\text{Pond surface area} = \text{pond volume}/\text{mean depth} = 39.27 \text{ ac-ft}/7.4 \text{ ft} = 5.31 \text{ ac}$$

2B. ORLANDO (ZONE 2) PROJECT

Since a wet detention pond cannot meet both the 90.5% removal criteria for TP and the 68.5% removal for TN, the remaining efficiency is achieved using dry retention. The design of the dry retention pond is dictated by the required removal for TN since this is where the largest deficit exists between the required removal and the removal provided by the wet detention pond. The required efficiency for the dry retention is calculated by Eq. 1 below:

$$\text{Treatment Train Efficiency} = \text{Eff}_1 + (1 - \text{Eff}_1) \times \text{Eff}_2 \quad (\text{Eq. 1})$$

where: Eff_1 = required efficiency of dry retention
 Eff_2 = efficiency of wet detention (42.5% for TN)

$$\text{Overall Eff.} = 0.685 = \text{Eff}_1 + (1 - \text{Eff}_1) \times 0.425$$

$$\text{Eff}_1 = 0.452 = 45.2\%$$

The required dry retention volume is estimated from the tables given in Appendix D using the development characteristics:

$$\text{DCIA Percentage} = 18.75\% \text{ of developed area}$$

$$\text{Non-DCIA CN} = 81.4$$

1. Required Dry Retention Depth

From Appendix D (Zone 2, the required removal efficiency of 45.2% is achieved with a dry retention depth between 0.00 and 0.25 inch.

For a dry retention depth of 0.25 inch, the treatment efficiency is obtained by iterating between DCIA percentages of 10 and 20, and for non-DCIA CN values between 80 and 90. The efficiency for the project conditions is 48.97%.

By iterating between 0.25 inch (48.97%) and 0.00 inch (0.0%), the dry retention depth required to achieve 45.2% removal is 0.23 inch.

Therefore, the required treatment train will consist of:

- a. 0.23 inch dry retention, followed by
- b. Wet detention pond with a 150-day mean residence time

2. Wet Detention Pond Characteristics

The required physical characteristics of the wet detention pond are determined based on the desired residence time and the impacts of the proposed dry retention pre-treatment.

A. Calculate annual runoff inputs to pond

The annual runoff coefficient for the development can be estimated using the tables included in Appendix C (Zone 2).

For: DCIA = 18.75% and non-DCIA CN = 81.4

The estimated “C” value is obtained by iteration as discussed previously.

Annual C Value = 0.253

The annual rainfall for the Orlando area = 50.0 inches (Appendix A.3)

Annual generated runoff volume =

$$90 \text{ acres} \times 50.0 \text{ inches/year} \times 1 \text{ ft/12 inches} \times 0.253 = 94.88 \text{ ac-ft/yr}$$

The calculated efficiency of 45.2% for the dry retention pre-treatment means that 45.2% of the annual runoff volume will be infiltrated into the ground and will not discharge directly into the wet detention pond. The annual runoff volume which reaches the pond is calculated as:

$$\text{Annual Inputs to Pond} = 94.88 \text{ ac-ft/yr} \times (1 - 0.452) = 51.99 \text{ ac-ft/yr}$$

For a 150-day residence time, the pond volume will be:

$$51.99 \text{ ac-ft/yr} \times 1 \text{ year/365 days} \times 150 \text{ days} = 21.37 \text{ ac-ft}$$

B. Estimate maximum allowable pond depth

The maximum allowable pond depth is directly related to the anticipated algal productivity within the pond. Assuming that wet detention ponds are primarily phosphorus-limited ecosystems, the productivity can be estimated based on the mean TP concentration.

1. Estimate runoff characteristics

For a single-family residential land use, the emc for TP in runoff can be obtained from Table 4-17:

$$\text{TP} = 0.327 \text{ mg/l (single-family residential)}$$

2. Calculate TP loading to wet detention pond

After the dry retention pre-treatment, the annual runoff input to the pond = 51.99 ac-ft/yr

TP load to pond =

$$51.99 \text{ ac-ft/yr} \times \frac{43,560 \text{ ft}^2}{\text{ac}} \times \frac{7.48 \text{ gal}}{\text{ft}^3} \times \frac{3.785 \text{ liter}}{\text{gal}} \times \frac{0.327 \text{ mg}}{\text{liter}} \times \frac{1 \text{ kg}}{10^6 \text{ mg}} = 20.97 \text{ kg TP/yr}$$

3. Calculate TP concentration in pond

At the proposed 150-day residence time, the TP removal was previously estimated as 77.4%.

Annual mass of TP remaining in water column =

$$20.97 \text{ kg TP/yr} \times (1 - 0.774) = 4.74 \text{ kg TP/yr}$$

This phosphorus mass will be distributed within the pond permanent pool (21.37 ac-ft) and the pond outflow. Assuming that inflow and outflow are approximately equal, the outflow will be 51.99 ac-ft.

Mean pond concentration =

$$\frac{4.74 \text{ kg TP}}{\text{yr}} \times \frac{1 \text{ yr}}{21.37 + 51.99 \text{ ac-ft}} \times \frac{1 \text{ ac}}{43,560 \text{ ft}^2} \times \frac{1 \text{ ft}^3}{7.48 \text{ gal}} \times \frac{1 \text{ gal}}{3.785 \text{ liter}} \times \frac{10^6 \text{ mg}}{\text{kg}} = 0.052 \text{ mg TP/liter} = 52 \text{ } \mu\text{g TP/liter}$$

4. Calculate mean chlorophyll-a concentration in pond

The relationship between TP and chlorophyll-a in a Florida waterbody is expressed by the following relationship:

$$\ln(\text{chl-a}) = 1.058 \ln(\text{TP}) - 0.934 \quad (\text{Eq. 4})$$

where: chl-a = chlorophyll-a concentration (mg/m³)

TP = total P concentration (μg/l)

$$\ln(\text{chl-a}) = 1.058 \ln(52) - 0.934$$

$$\text{chl-a} = e^{3.25} = 25.7 \text{ mg/m}^3$$

5. Calculate mean Secchi disk depth

The relationship between chlorophyll-a and Secchi disk depth in a Florida waterbody is expressed by the following relationship:

$$SD = \frac{24.2386 + [(0.3041)(chyl - a)]}{(6.0632 + chyl - a)}$$

where: SD = Secchi disk depth (m)
 chyl-a = chlorophyll-a (mg/m³)

$$SD = \frac{24.2386 + [(0.3041) (25.7)]}{(6.0632 + 25.7)} = 1.01 \text{ m} = 3.31 \text{ ft}$$

6. Calculate depth of anoxic conditions in pond

Using the relationship expressed in Eq. 5, the depth of anoxic conditions within the pond can be estimated as follows:

$$\text{Depth of } DO < 1 = 3.035 \times \text{Secchi} + 0.02164 \times (\text{chyl-a}) - 0.004979 \times \text{Total P}$$

where:

Depth of DO < 1 = anoxic depth (m)
 Secchi = Secchi disk depth (m)
 chyl-a = chlorophyll-a concentration (mg/m³)
 Total P = total phosphorus concentration (µg/l)

$$\text{Depth of } DO < 1 = 3.035 (1.01) + 0.02164 (25.7) - 0.004979 (52) = \underline{3.36 \text{ m}} = \underline{11.0 \text{ ft}}$$

If the proposed pond depth exceeds the estimated photic zone depth of 11.0 ft, aeration or other mixing will be required for areas deeper than 11.0 ft to maintain a well mixed water column. The aeration or mixing must be sufficient to mix the water column to the maximum pond depth. The specific design of the required system should be selected by a qualified aeration specialist.

As an alternative to providing aeration or mixing within the pond, the required permanent pool volume could be considered as only the volume above the anoxic zone and not the entire volume of the pond. Areas below the anoxic depth would be considered as dead storage, although these areas would provide a significant storage volume for collected solids.

If the pond is modified, based on the results of the calculated anoxic zone depth, the calculations would need to be redone to estimate new values for total phosphorus, Secchi disk depth, chlorophyll-a, and depth of anoxia to demonstrate that the new design meets the required permanent pool volume above the zone of anoxia.

7. Estimate pond dimensions

For the estimation of pond dimensions, assume that the mean depth (pond volume/pond area) is $2/3$ of the maximum depth.

$$\text{Mean pond depth} = 11.0 \text{ ft} \times 2/3 = 7.3 \text{ ft}$$

$$\text{Pond surface area} = \text{pond volume}/\text{mean depth} = 21.37 \text{ ac-ft}/7.3 \text{ ft} = 2.91 \text{ ac}$$

2C. KEY WEST (ZONE 3) PROJECT

Since the wet detention pond fails to meet the 88.4% removal criteria for TP and the 61.4% removal for TN, the remaining efficiency is achieved using dry retention. The design of the dry retention pond is dictated by the required removal for TN since this is where the largest deficit exists between the required removal and the removal provided by the wet detention pond. The required efficiency for the dry retention is calculated by Eq. 1 below:

$$\text{Treatment Train Efficiency} = \text{Eff}_1 + (1 - \text{Eff}_1) \times \text{Eff}_2 \quad (\text{Eq. 1})$$

where: Eff_1 = required efficiency of dry retention
 Eff_2 = efficiency of wet detention (42.5% for TN)

$$0.614 = \text{Eff}_1 + (1 - \text{Eff}_1) \times 0.425$$

$$\text{Eff}_1 = 0.329 = 32.9\%$$

The required dry retention volume is estimated from the tables given in Appendix D using the development characteristics:

$$\text{DCIA Percentage} = 18.75\% \text{ of developed area}$$

$$\text{Non-DCIA CN} = 81.4$$

1. Required Dry Retention Depth

From Appendix D (Zone 3), the required removal efficiency of 32.9% is achieved with a dry retention depth between 0.00 and 0.25 inch.

For a dry retention depth of 0.25 inch, the treatment efficiency is obtained by iterating between DCIA percentages of 10 and 20, and for non-DCIA CN values between 80 and 90. The efficiency for the project conditions is 42.9%.

By iterating between 0.00 inch (0.0%) and 0.25 inch (42.9%), the dry retention depth required to achieve 32.9% removal is 0.19 inch.

Therefore, the required treatment train will consist of:

- a. 0.19 inch dry retention, followed by
- b. detention pond with a 150-day mean residence time

2. Wet Detention Pond Characteristics

The required physical characteristics of the wet detention pond are determined based on the desired residence time and the impacts of the proposed dry retention pre-treatment.

A. Calculate annual runoff inputs to pond

The annual runoff coefficient for the development can be estimated using the tables included in Appendix C (Zone 3).

For: DCIA = 18.75% and non-DCIA CN = 81.4

The estimated "C" value is obtained by iteration as discussed previously.

Annual C Value = 0.266

The annual rainfall for the Key West area = 40.0 inches (Appendix A.3)

Annual generated runoff volume =

$$90 \text{ acres} \times 40.0 \text{ inches/year} \times 1 \text{ ft}/12 \text{ inches} \times 0.266 = 79.8 \text{ ac-ft/yr}$$

The calculated efficiency of 32.9% for the dry retention pre-treatment means that 32.9% of the annual runoff volume will be infiltrated into the ground and will not discharge directly into the wet detention pond. The annual runoff volume which reaches the pond is calculated as:

$$\text{Annual Inputs to Pond} = 79.8 \text{ ac-ft/yr} \times (1 - 0.329) = 53.55 \text{ ac-ft/yr}$$

For a 150-day residence time, the pond volume will be:

$$53.55 \text{ ac-ft/yr} \times 1 \text{ year}/365 \text{ days} \times 150 \text{ days} = 22.01 \text{ ac-ft}$$

B. Estimate maximum allowable pond depth

The maximum allowable pond depth is directly related to the anticipated algal productivity within the pond. Assuming that wet detention ponds are primarily phosphorus-limited ecosystems, the productivity can be estimated based on the mean TP concentration.

1. Estimate runoff characteristics

For a single-family residential land use, the emc for TP in runoff can be obtained from Table 4-17:

$$TP = 0.327 \text{ mg/l (single-family residential)}$$

2. Calculate TP loading to wet detention pond

After the dry retention pre-treatment, the annual runoff input to the pond = 53.55 ac-ft/yr

TP load to pond =

$$53.55 \text{ ac-ft/yr} \times \frac{43,560 \text{ ft}^2}{\text{ac}} \times \frac{7.48 \text{ gal}}{\text{ft}^3} \times \frac{3.785 \text{ liter}}{\text{gal}} \times \frac{0.327 \text{ mg}}{\text{liter}} \times \frac{1 \text{ kg}}{10^6 \text{ mg}} = 21.60 \text{ kg TP/yr}$$

3. Calculate TP concentration in pond

At the proposed 150-day residence time, the TP removal was previously estimated as 77.4%.

Annual mass of TP remaining in water column =

$$21.60 \text{ kg TP/yr} \times (1 - 0.774) = 4.88 \text{ kg TP/yr}$$

This mass will be distributed within the pond permanent pool volume (22.01 ac-ft) and the pond outflow. Assuming that inflow and outflow are approximately equal, the outflow volume is 53.55 ac-ft.

Mean pond concentration =

$$\frac{4.88 \text{ kg TP}}{\text{yr}} \times \frac{1 \text{ yr}}{22.01 + 53.55 \text{ ac-ft}} \times \frac{1 \text{ ac}}{43,560 \text{ ft}^2} \times \frac{1 \text{ ft}^3}{7.48 \text{ gal}} \\ \times \frac{1 \text{ gal}}{3.785 \text{ liter}} \times \frac{10^6 \text{ mg}}{\text{kg}} = 0.052 \text{ mg TP/liter} = 52 \text{ } \mu\text{g TP/liter}$$

4. Calculate mean chlorophyll-a concentration in pond

The relationship between TP and chlorophyll-a in a Florida waterbody is expressed by the following relationship:

$$\ln(\text{chl-a}) = 1.058 \ln(\text{TP}) - 0.934 \quad (\text{Eq. 4})$$

where: chl-a = chlorophyll-a concentration (mg/m³)
 TP = total P concentration (µg/l)

$$\ln(\text{chl-a}) = 1.058 \ln(52) - 0.934$$

$$\text{chl-a} = e^{3.25} = 25.7 \text{ mg/m}^3$$

5. Calculate mean Secchi disk depth

The relationship between chlorophyll-a and Secchi disk depth in a Florida waterbody is expressed by the following relationship:

$$SD = \frac{24.2386 + [(0.3041)(\text{chl-a})]}{(6.0632 + \text{chl-a})}$$

where: SD = Secchi disk depth (m)
 chl-a = chlorophyll-a (mg/m³)

$$SD = \frac{24.2386 + [(0.3041)(25.7)]}{(6.0632 + 25.7)} = 1.01 \text{ m} = 3.31 \text{ ft}$$

6. Calculate depth of anoxic conditions in pond

Using the relationship expressed in Eq. 5, the depth of anoxic conditions within the pond can be estimated as follows:

$$\text{Depth of } DO < 1 = 3.035 \times \text{Secchi} + 0.02164 \times (\text{chl-a}) - 0.004979 \times \text{Total P}$$

where:

Depth of DO < 1	=	anoxic depth (m)
Secchi	=	Secchi disk depth (m)
chl-a	=	chlorophyll-a concentration (mg/m ³)
Total P	=	total phosphorus concentration (µg/l)

$$\text{Depth of DO} < 1 = 3.035 (1.01) + 0.02164 (25.7) - 0.004979 (52) = \underline{3.36 \text{ m}} = \underline{11.0 \text{ ft}}$$

If the proposed pond depth exceeds the estimated photic zone depth of 11.0 ft, aeration or other mixing will be required for areas deeper than 11.0 ft to maintain a well mixed water column. The aeration or mixing must be sufficient to mix the water column to the maximum pond depth. The specific design of the required system should be selected by a qualified aeration specialist.

As an alternative to providing aeration or mixing within the pond, the required permanent pool volume could be considered as only the volume above the anoxic zone and not the entire volume of the pond. Areas below the anoxic depth would be considered as dead storage, although these areas would provide a significant storage volume for collected solids.

If the pond is modified, based on the results of the calculated anoxic zone depth, the calculations would need to be redone to estimate new values for total phosphorus, Secchi disk depth, chlorophyll-a, and depth of anoxia to demonstrate that the new design meets the required permanent pool volume above the zone of anoxia.

7. Estimate pond dimensions

For the estimation of pond dimensions, assume that the mean depth (pond volume/pond area) is 2/3 of the maximum depth.

$$\text{Mean pond depth} = 11.0 \text{ ft} \times 2/3 = 7.3 \text{ ft}$$

$$\text{Pond surface area} = \text{pond volume}/\text{mean depth} = 22.01 \text{ ac-ft}/7.3 \text{ ft} = 3.02 \text{ ac}$$

7.4 Conclusions

7.4.1 Dry Retention

The design examples illustrated in the previous sections are intended to present alternative stormwater designs which will meet both the 80% and 95% pollutant reduction goals outlined in Chapter 62-40 FAC as well as a condition of no net increase in pollutant loadings for a developed site under post-development conditions. The design examples provide calculations for treatment systems comprised exclusively of dry retention as well as a combination of wet detention with dry retention pre-treatment. The hypothetical site consists of a 100-acre rangeland/forest parcel which is converted into a single-family residential community with a DCIA percentage of 18.7% and a non-DCIA curve number of 81.4.

A comparison of existing and proposed dry retention stormwater treatment requirements, based upon the hypothetical 100-acre parcel, is given in Table 7-1 for developments in Pensacola, Orlando, and Key West. Existing requirements for dry retention stormwater treatment at the Pensacola site are based upon the FDEP criteria outlined in Chapter 62-25 FAC. Dry retention stormwater treatment requirements for the Orlando site are based upon SJRWMD design criteria, while dry retention treatment requirements for the Key West site are based upon SFWMD design criteria.

TABLE 7-1
COMPARISON OF EXISTING AND REQUIRED DRY
RETENTION STORMWATER TREATMENT REQUIREMENTS

DESIGN OBJECTIVE	RETENTION REQUIREMENT BY REGION		
	PENSACOLA – ZONE 1 (FDEP)	ORLANDO- ZONE 2 (SJRWMD)	KEY WEST- ZONE 3 (SFWMD)
<u>80% Pollutant Removal</u>			
a. Existing	0.50"	0.50" off-line or 1.00" on-line	0.50"
b. Required	1.52"	0.94"	1.66"
<u>95% Pollutant Removal (OFW)</u>			
a. Existing	0.75"	0.75" off-line or 1.50" on-line	0.75"
b. Required	3.66"	2.45"	3.62"
<u>Post ≤ Pre Loadings</u>			
a. Required Removals (%)	TN: 63.2% TP: 89.0%	TN: 68.5% TP: 90.5%	TN: 61.4% TP: 88.4%
b. Required Retention	2.42"	1.67"	2.63"

Under existing conditions, the dry retention treatment requirement for the hypothetical development, assuming that the development does not discharge to an OFW, would be 0.5 inch of retention for the Pensacola and Key West sites. At the Orlando site, the dry retention requirement would be 0.5 inch for an off-line system and 1.00 inch for an on-line system. Retention requirements necessary to achieve an 80% reduction in the annual runoff volume, assumed to be equivalent to an 80% pollutant removal efficiency, are indicated under the column designated as "required". To achieve an 80% pollutant removal in the Pensacola area, the dry retention system would have to provide a treatment volume of 1.52 inches of runoff. In the Orlando area, the required dry retention treatment volume would be 0.94 inch, with a dry retention requirement of 1.66 inches in the Key West area.

As seen in Table 7-1, the existing design criteria for dry retention in the Pensacola and Key West areas fall well short of the actual dry retention treatment volume required to achieve an 80% annual pollutant removal efficiency. For a project designed in the Orlando area, based upon SJRWMD design criteria, the dry retention requirement for an off-line system would fail to meet the 80% pollutant removal goal, while the pollutant removal goal would be exceeded by an on-line retention system with 1.00 inch of dry retention.

Existing and proposed dry retention requirements are also provided for developments which discharge to OFWs which are assumed to be designed according to the 95% pollutant reduction target goal outlined in Chapter 62-40 FAC. The applicable design criteria for each of the three project areas is 50% additional dry retention treatment volume above the amount necessary to achieve 80% pollutant removal. For projects designed in the Pensacola and Key West areas, this treatment volume requirement becomes 0.75 inch. If a development is constructed in the Orlando area, the current dry retention requirement becomes 0.75 inch for off-line systems and 1.50 inch for on-line systems. However, the actual dry retention treatment requirements necessary to achieve a 95% pollutant removal far exceed the existing dry retention treatment requirements. Dry retention requirements for 95% pollutant removal are 3.66 inches for the Pensacola area, 2.45 inches for the Orlando area, and 3.62 inches for the Key West area.

Dry retention requirements necessary to achieve post \leq pre-development loadings are summarized at the bottom of Table 7-1. The required removals necessary to achieve no net increase in loadings for total nitrogen range from 61.4-68.5%. These values indicate that a pollutant removal efficiency of 80% is not required for total nitrogen to achieve no net increase in pollutant loadings. Required removal efficiencies for total phosphorus to achieve no net increase in pollutant loadings range from 88.4-90.5%, suggesting that stormwater management systems designed for an 80% pollutant removal will fail to achieve post \leq pre-development loadings for total phosphorus. Based upon these values, it is apparent that a stormwater management system designed to achieve 80% pollutant removal will remove more than the required amount of total nitrogen, while removing less than the required amount of total phosphorus. A stormwater management system designed to achieve a true 95% reduction in pollutant loadings will remove substantially more total nitrogen and total phosphorus than required to achieve post \leq pre-development loadings.

Based upon the comparative information summarized in Table 7-1, it appears that designing stormwater management systems to achieve an arbitrary pollutant removal goal for both total nitrogen and total phosphorus is an ineffective method for achieving compliance with water quality or anti-degradation criteria. A much more effective method of addressing stormwater treatment requirements appears to be designs based upon post \leq pre-development loadings. The proposed dry retention requirements necessary to achieve this goal for the hypothetical projects range from 1.67 inches in the Orlando area to 2.42 inches in the Pensacola area. These values are greater than the actual dry retention requirements necessary to achieve an 80% pollutant removal goal, but are substantially less than the dry retention requirements necessary to achieve a 95% pollutant removal goal. If post \leq pre-development criteria are utilized, there would be no need for supplemental design criteria for discharges into OFWs since all projects would result in no net increase in pollutant loadings into the receiving waterbody. However, it should be noted that the post \leq pre-development dry retention design criteria listed at the bottom of Table 7-1 are based upon the removal efficiencies required for total phosphorus. Since all constituents are removed at the same rate using dry retention, an excess removal would still be achieved for total nitrogen.

7.4.2 Wet Detention

A comparison of existing and proposed wet detention stormwater treatment requirements to achieve the evaluated design objectives is given in Table 7-2. Under existing conditions, wet detention systems designed in the Pensacola area according to FDEP design criteria must have a treatment volume equivalent to 1.00 inch of runoff over the project area. The FDEP design criteria do not specify requirements for detention time. The project constructed in the Orlando area would be designed according to SJRWMD criteria. These criteria specify a treatment volume of 1 inch of runoff, with a minimum 14-day wet season detention time and a maximum pond depth of 12 feet. The project constructed in the Key West area would be designed according to SFWMD design criteria which specify a treatment volume of 1 inch of runoff, with no specified detention time and 25-50% of the pond depth greater than 12 feet.

A summary of proposed wet detention design criteria necessary to achieve the 80% pollutant removal goal is provided in Table 7-2. For this analysis, the treatment volume is assumed to be the same as under existing design criteria. Although this treatment volume is often termed the “water quality” component of the system, it has very little impact on the overall performance efficiency of the system and primarily regulates the drawdown characteristics of the pond following a storm event. The design example assumes a wet detention pond with a detention pond of 150 days since this design tends to maximize removal efficiencies for nitrogen and phosphorus. However, lower detention times could also be used, although this would increase treatment requirements for other portions of the overall treatment train.

Although wet detention ponds can provide a removal efficiency of 80% or more for total phosphorus at extended detention times, wet detention ponds are not capable of providing an 80% pollutant removal for total nitrogen. As a result, retention pre-treatment will be required to increase the overall performance efficiency of the system to 80% for total nitrogen. Based on the analyses presented in the previous sections, this will require a dry retention pre-treatment of 0.81 inch in the Pensacola area, 0.49 inch in the Orlando area, and 0.75 inch in the Key West area. Under the alternative design, the maximum depth for each pond is based upon predicted water quality characteristics and the anticipated depth of anoxia within the pond rather than an arbitrary depth standard. Ponds which are constructed deeper than the anticipated depth of anoxia may require supplemental aeration or circulation to maintain aerobic conditions. It should be noted that, while this design will meet the 80% pollutant removal goal for total nitrogen, the overall pollutant removal for total phosphorus will substantially exceed 80%.

Wet detention design criteria to achieve a 95% pollutant removal are also summarized in Table 7-2. Under existing design criteria, the treatment volume would be increased by 50% for each of the three projects, while other components of the wet detention pond would remain unchanged. Under the proposed alternative wet detention design, the treatment volumes are assumed to be the same as those provided under existing conditions since the treatment volumes have little impact on overall system performance. The example summarized in a previous section utilizes a 100-day detention pond, although other detention times could be utilized as well. The remaining dry retention pre-treatment necessary to boost the overall performance of the system to 95% ranges from 2.42 inches in the Orlando area to greater than 4 inches in the Key West area. These relatively large dry retention requirements are necessary primarily to boost the removal efficiency for total nitrogen to 95%, while the removal efficiency for total phosphorus will substantially exceed 95%.

TABLE 7-2

COMPARISON OF EXISTING AND REQUIRED WET
DETENTION STORMWATER TREATMENT REQUIREMENTS

DESIGN OBJECTIVE	TREATMENT REQUIREMENT BY REGION		
	PENSACOLA - ZONE 1 (FDEP)	ORLANDO - ZONE 2 (SJRWMD)	KEY WEST - ZONE 3 (SFWMD)
80% Pollutant Removal			
a. Existing	1. 1" of runoff treatment volume 2. no specified detention time 3. depth < 12 feet	1. 1" of runoff treatment volume 2. minimum 14-day detention time 3. depth < 12 feet	1. 1" of runoff treatment volume 2. no specified detention time 3. 25-50% > 12 feet
b. Proposed	1. 1" of runoff treatment volume 2. 200-day detention time 3. 0.69" retention pre-treatment 4. maximum depth based on water quality	1. 1" of runoff treatment volume 2. 200-day detention time 3. 0.45" retention pre-treatment 4. maximum depth based on water quality	1. 1" of runoff treatment volume 2. 200-day detention time 3. 0.66" retention pre-treatment 4. maximum depth based on water quality
95% Pollutant Removal (OFW)			
a. Existing	1. 1.5" of runoff treatment volume 2. no specified detention time 3. depth < 12 feet	1. 1.5" of runoff treatment volume 2. minimum 14-day detention time 3. depth < 12 feet	1. 1.5" of runoff treatment volume 2. no specified detention time 3. 25-50% > 12 feet
b. Proposed	1. 1.5" of runoff treatment volume 2. 100-day detention time 3. 2.45" dry retention pre-treatment	1. 1.5" of runoff treatment volume 2. 100-day detention time 3. 1.63" dry retention pre-treatment	1. 1.5" of runoff treatment volume 2. 100-day detention time 3. >4" dry retention pre-treatment
Post ≤ Pre Loadings			
a. Required Removals (%)	TN: 63.2% TP: 89.0%	TN: 68.5% TP: 90.5%	TN: 61.4% TP: 88.4%
b. Proposed Retention	1. 1.5" of runoff treatment volume 2. 150-day wet detention 3. 0.24" dry retention pre-treatment	1. 1.5" of runoff treatment volume 2. 150-day wet detention 3. 0.23" dry retention pre-treatment	1. 1.5" of runoff treatment volume 2. 150-day wet detention 3. 0.19" dry retention pre-treatment

Proposed wet detention treatment requirements necessary to achieve post \leq pre-development loadings are summarized at the bottom of Table 7-2. These are the same values utilized in Table 7-1. A wet detention treatment train which will achieve post \leq pre-development loadings is provided in the bottom row of Table 7-2. This can be accomplished using a wet detention pond with a 150-day detention time, with dry retention pre-treatment ranging from 0.19-0.24 inch. The requirements necessary to achieve post \leq pre-development loadings are less than the requirements necessary to achieve a true 80% pollutant removal goal since the elevated removal efficiencies are no longer required for total nitrogen. The detention time of the wet detention system listed under the proposed conditions could be reduced with a proportionate increase in the volume of dry retention pre-treatment for each of the three options.

7.5 Summary

Based on the analyses provided in the previous sections, it is apparent that the most appropriate method of developing stormwater treatment requirements is to utilize a post \leq pre-development loading conditions. Developing stormwater design criteria to achieve an arbitrary 80% pollutant removal goal will provide substantially higher than required removals for total nitrogen while providing total phosphorus removals in excess of 80%. Requiring stormwater management systems to be designed to achieve an arbitrary 95% pollutant removal goal will far exceed the required removals for both total nitrogen and total phosphorus necessary to achieve a post \leq pre-development loading, while resulting in substantially elevated stormwater treatment requirements and costs compared with existing conditions.

SECTION 8

REFERENCES

Bahk, B.M. (1997). "An Investigation of a Wet Detention Pond Used to Treat Stormwater and Irrigation Runoff from an Agricultural Basin." Proceedings of the Fifth Biennial Stormwater Research Conference, November 5-7, 1997.

Bahk, B. and M. Kehoe. (1997). "A Survey of Outflow Water Quality from Detention Ponds in Agriculture." Report submitted to the Southwest Florida Water Management District - Environmental Section.

Camp, Dresser & McKee. (1984). "Tributary Streamflow and Pollutant Loading." Delivered to Tampa Bay for Florida Department of Environmental Regulation, Tallahassee, FL.

Camp, Dresser & McKee. (1985). "Southeast Area Stormwater Management Study - Manatee County, Florida." Bradenton, FL.

Carr, D.W. and M.J. Kehoe. (1997). "Outfall Water Quality from Wet Detention Systems." Southwest Florida Water Management District, Environmental Section/Resource Projects Department, Brooksville, FL.

Chow, V.T.; Maidment, D.R.; and Mays, L.W. (1988). "Applied Hydrology." New York: McGraw-Hill Book Company.

Cullum, M.G. (1984). "Evaluation of the Water Management System at a Single-Family Residential Site: Water Quality Analysis for Selected Storm Events at Timbercreek Subdivision in Boca Raton, Florida." South Florida Water Management District, Tech. Pub. 84-11 Volume II, West Palm Beach, FL.

DB Environmental, Inc. (2005). "Quantifying the Effect of a Vegetated Littoral Zone on Wet Detention Pond Pollutant Load Reduction". Final Report prepared for the Florida Department of Environmental Protection, Tallahassee, FL.

Dillon, P.J., and F.H. Rigler. (1974). "The Phosphorus-Chlorophyll Relationship in Lakes." Limnol. Oceanogr., Vol. 19, pp. 767-773.

East Central Florida Regional Planning Council. (1978). "208 Areawide Water Quality Management Plan – Orlando Metropolitan 208 Planning Area, Volume III: Point/Nonpoint Source Needs and Recommendations." Prepared for the 208 Areawide Water Quality Management Planning Program. Winter Park, FL.

East Central Florida Regional Planning Council. (1984). "Lake Tohopekaliga Drainage Area Agricultural Runoff Management Plan." Winter Park, FL.

East Central Florida Regional Planning Council. (1985). "Point and Nonpoint Source Assessment of the Middle St. Johns River - Volume I." Winter Park, FL.

East Central Florida Regional Planning Council and the South Florida Water Management District. (1988). "Boggy Creek Water Quality Management Study - Final Report." Winter Park, FL.

Environmental Research & Design, Inc. (ERD). (2000). "Winter Park Chain-of-Lakes Groundwater/Sediment Study." Final Report prepared for the City of Winter Park, Winter Park, FL.

Environmental Research & Design, Inc. (ERD). (2002). "Lake Morton Water Quality Diagnostic Evaluation." Final Report prepared for the City of Lakeland Lakes and Stormwater Division, Lakeland, FL.

Environmental Research & Design, Inc. (ERD). (2004). "Lake Holden Revised Hydrologic/Nutrient Budget and Management Plan." Final Report prepared for Professional Engineering Consultants, Orlando, FL.

Environmental Research & Design, Inc. (ERD). (2004). "Nonpoint Source Model Development and Basin Management Strategies for Lemon Bay." Final Report prepared for the Southwest Florida Water Management District, Brooksville, FL.

Fall, C. (1987). "Characterization of Agricultural Pump Discharge Quality in the Upper St. Johns River Basin." St. Johns River Water Management District, Contract #WM108, Palatka, FL.

Fall, C. (1990). "Characterization of Agricultural Pump Discharge Quality in the Upper St. Johns River Basin." St. Johns River Water Management District, Palatka, FL.

Fall, C. and J. Hendrickson. (1987). "An Investigation of the St. Johns River Water Control District: Reservoir Water Quality and Farm Practices." St. Johns River Water Management District, Contract #WM108, Palatka, FL.

Fall, C., P. Jennings, and M.Von Canal. (1995). "The Effectiveness of Agricultural Permitting in the Upper St. Johns River Water." St. Johns River Water Management District, Palatka, FL.

Federico, A.C. (1977). "Investigations of the Relationship Between Land Use, Rainfall, and Runoff Quality in the Taylor Creek Watershed." South Florida Water Management District, Tech. Pub. 77-3, West Palm Beach, FL.

Florida Department of Environmental (Regulation) Protection. (1988). "The Florida Development Manual: A Guide to Sound Land and Water Management." Prepared by the Nonpoint Source Management Department. Tallahassee, FL.

Gaggiani, N.G. and A.G. Lamonds. (1978). "Chemical and Biological Quality of Lakes Faith, Hope and Charity at Maitland, Florida, with Emphasis on the Effects on Storm Runoff and Bulk Precipitation, 1971-74." U.S. Geological survey Open-File Report 77-491, Tallahassee, FL.

German, E.R. (1983). "Water Quality of Lakes Faith, Hope, Charity and Lucien, 1979-79, in an Area of Residential Development and Highway Construction at Maitland, Florida." U.S. Geological Survey Water Resources Investigations 82-51, Tallahassee, FL.

Gregg, J.R. (1984). "Evaluation of the Water Management System of a Single-Family Residential Site: Hydrology and Hydraulics of Timbercreek Subdivision in Boca Raton, Florida." South Florida Water Management District Tech. Pub. 84-11 Volume I, West Palm Beach, FL.

Gregg, J.R. and T.R. Slater. (1989). "Evaluation of the Surface Water Management System at a Single-Family Residential Development: Springhill Subdivision." South Florida Water District Tech. Pub. 89, West Palm Beach, FL.

Gupta, M.K. (1981). "Constituents of Highway Runoff." Executive Summary, Volume VI - Final Report. Federal Highway Administration Report #FHWA/RD-81/047, Washington, D.C.

Gupta, M.K., R.W. Agnew, D. Gruber, and W. Kreutzberger. (1981). "Constituents of Highway Runoff." Characteristics of Highway Runoff from Operating Highways - Research Report; Volume IV - Final Report. Federal Highway Administration Report #FHWA/RD-81/045, Washington, D.C.

Harper, H.H. (1985). "Fate of Heavy Metals from Highway Runoff in Stormwater Management Systems." Ph.D. Dissertation for the University of Central Florida, Orlando, FL.

Harper, H.H. (1988). "Effects of Stormwater Management Systems on Groundwater Quality." FDEP Project #WM190. Florida Department of Environmental Regulation, Tallahassee, FL.

Harper, H.H. (1994). "Stormwater Loading Rate Parameters for Central and South Florida." Revised October 1994.

Harper, H.H. (1995). "Pollutant Removal Efficiencies for Typical Stormwater Management Systems in Florida." Proceedings of the 4th Biennial Stormwater Research Conference, Southwest Florida Water Management District, Clearwater, FL, October 18-20, 1995.

Harper, H.H. and J.L. Herr. (1993). "Treatment Efficiencies of Detention with Filtration Systems." Final Report to the St. Johns River Water Management District for Project No. 90B103, August 1993.

Harper, H.H., J.L. Herr, and D.M. Baker. (2000). Bradfordville Stormwater Study." Final Report prepared for the Board of County Commissioners, Leon County, FL.

Harper, H.H., M.P. Wanielista, B.M. Fries, and D.M. Baker. (1986). "Stormwater Treatment by Natural Systems." Star Project #84-026 - Final Report. Florida Department of Environmental Regulation, Tallahassee, FL.

Harper, H.H., M.P. Wanielista, D.M. Baker, B.M. Fries, and E.H. Livingston. (1985). "Treatment Efficiencies of Residential Stormwater Runoff in a hardwood Wetland." Lake and Reservoir Management - Proceedings of the Fifth Annual Conference and International Symposium on Applied Lake and Watershed Management, Lake Geneva, WI, November 13-16, 1985.

Harper, H.H., M.P. Wanielista, Y.A. Yousef, and D. Didomenico. (1982). "Lake Eola Restoration: Water Quality Background and Stormwater Management Practices." University of Central Florida, Orlando, FL.

Hendrickson, J. (1987). "Effect of the Willowbrook Farms Detention Basin on the Quality of Agricultural Runoff." St. Johns River Water Management District, Contract #WM108, Palatka, FL.

Hendrickson, J. (No date given). Unpublished data on 3 citrus sites in Florida.

Holler, J.D. (1989). "Water Quality Efficiency of an Urban Commercial Wet Detention Stormwater Management System at the Boynton Beach Mall in South Palm Beach County, Florida." Florida Scientist, Vol. 52, No. 1, pp. 48-57.

Holtkamp, M.L. (1998). "An Assessment of the Effectiveness of Enhancing the Existing Stormwater Pond Near 102nd Avenue on its Water Quality Function." Draft Report for the Southwest Florida Water Management District - SWIM Section.

Howie, B. and B.G. Waller. (1986). "Chemical Effects of Highway Runoff on the Surficial Aquifer, Broward County, Florida." U.S. Geological Survey Water Resources Investigations Report 86-4200, Tallahassee, FL.

Kehoe, M.J., C.W. Dye, and B.T. Rushton. (1994). "A Survey of the Water Quality of Wetlands-Treatment Stormwater Ponds – Final Report." Southwest Florida Water Management District, Environmental Section, Brooksville, FL.

Lopez, M.A. and R.F. Giovannelli. (1984). "Water Quality Characteristics of Urban Runoff and Estimates of Annual Loads in the Tampa Bay Area, Florida, 1975-80." U.S. Geological Survey Water Resources Investigations Report 83-4181, Tallahassee, FL.

Lynard, W.G., E.J. Finnemore, J.A. Loop, and R.M. Finn. (1980). "Urban Stormwater Management and Technology: Case Histories." EPA 68-03-2617. Cincinnati, OH.

Martin, E.H., and Miller, R.A. (1987). "Efficiency of an Urban Stormwater Detention System." Proceedings of the Fourth International Conference on Urban Storm Drainage.

Mattraw, Jr., H.C., and R.A. Miller. (1981). "Stormwater Quality Processes for Three Land-Use Areas in Broward County, Florida." U.S. Geological Survey Report #USGS/WRI 81-23, Tallahassee, FL.

Mattraw, Jr., H.C., J. Hardee, and R.A. Miller. (1978). "Urban Stormwater Runoff Data for a Residential Area, Pompano Beach, Florida." U.S. Geological Survey Open-File Report 78-324, Tallahassee, FL.

McCuen, R.H. (1982). "A Guide to Hydrologic Analysis Using SCS Methods." Englewood Cliffs, NJ: Prentice-Hall, Inc.

McKenzie, D.J. and G.A. Irwin. (1983). "Water Quality Assessment of Stormwater Runoff from a Heavily Used Urban Highway Bridge in Miami, Florida." U.S. Geological Survey Water Resources Investigations Report 83-4153, Tallahassee, FL.

Miller, R.A. (1979). "Characteristics of Four Urbanized Basins in South Florida." U.S. Department of the Interior Geological Survey Open- File Report 79-694. Tallahassee, FL.

Miller, R.A. (1985). "Percentage Entrainment of Constituent Loads in Urban Runoff, South Florida." U.S. Geological Survey Water Resources Investigations Report 84-4329. Tallahassee, FL.

Miller, W.L. (1988). "Description and Evaluation of the Effects of Urban and Agricultural Development on the Surficial Aquifer System, Palm Beach County, Florida." U.S. Geological Survey Water Resources Investigations Report 88-4056, Tallahassee, FL.

Post, Buckley, Schuh & Jernigan, Inc. (1982). "Evaluation of Two Best Management Practices: A Grassy Swale and a Retention/Detention Pond." Brevard 208 Continuing Planning Process. EPA Grant No. 067-301.00.

Rushton, B.T., and C.W. Dye. (1993). "An In-depth Analysis of a Wet Detention Stormwater System." Southwest Florida Water Management District, Brooksville, FL.

Rushton, B., C. Miller, and C. Hull. (1995). "Residence Time as a Pollutant Removal Mechanism in Stormwater Detention Ponds." Proceedings of the Fourth Biennial Stormwater Research Conference, Clearwater Beach, FL, October 18-20, 1995.

Sawka, G.J., D.W. Black, and M.N. Allhands. (1993). "Evaluation of Wet Detention for Treatment of Surface Water Runoff from a Citrus Grove in South Florida." Proceedings of the Third Biennial Stormwater Research Conference, Tampa, FL, October 7-8, 1993.

Southwest Florida Water Management District. (1988). "Archie Creek/Coastal Areas and Buckhorn Creek Watersheds - Stormwater Management Plan." Final Report.

Toet, C., T. Hvitved-Jacobsen, and Y.A. Yousef. (1990). "Pollutant Removal and Eutrophication in Urban Runoff Detention Ponds." Wat. Sci. Tech. Vol. 22, No. 10/11, pp. 197-204.

United States Department of Agriculture. (1986). "Urban Hydrology for Small Watersheds." Technical Release 55 prepared by the Natural Resources Conservation Service – Engineering Division.

United States Environmental Protection Agency (U.S. EPA). (1983). "Results of the National Urban Runoff Program (NURP)." Executive Summary; Volume I - Final Report; Volume II - Appendices; Volume III - Data Appendix. U.S. EPA, Washington, D.C.

United States Geological Survey (USGS). (1985). "Constituent-Load Changes in Urban Stormwater Runoff Routed Through a Detention Pond-Wetlands System in Central Florida." Water Resources Investigations Report No. 85-4310.

United States Geological Survey (USGS). (1985). "Percentage Entrainment of Constituent Loads in Urban Runoff, South Florida." Water Resources Investigations Report No. 84-4329.

Waller, B.G. (1982). "Effects of Land Use on Surface Water Quality in the East Everglades, Dade County, Florida." U.S. Geological Survey Water Resources Investigation 81-59, Tallahassee, FL.

Waller, B.G., H. Klein, and L.J. Lefkoff. (1984). "Attenuation of Stormwater Contaminants from Highway Runoff within Unsaturated Limestone, Dade County, Florida." U.S. Geological Survey Water Resources Investigations Report 84-4083, Tallahassee, FL.

Wanielista, M.P. (1978). Stormwater Management: Quantity and Quality. Ann Arbor, MI: Ann Arbor Science Publishers.

Wanielista, M.P., Y.A. Yousef, and J.S. Taylor. (1982). "Stormwater Management to Improve Lake Water Quality." EPA Grant 600/82-048.

Weinburg, M., D. Reece, and D. Allman. (1980). "Effect of Urban Stormwater Runoff to a Man-Made Lake on Groundwater Quality." South Florida Water Management District Tech. Pub. 80-4, West Palm Beach, FL.

Whalen, P.J. and M.G. Cullum. (1988). "An Assessment of Urban Land Use/Stormwater Runoff Quality Relationships and Treatment Efficiencies of Selected Stormwater Management Systems." South Florida Water Management District Tech. Pub. 88-9, West Palm Beach, FL.

Yousef, Y.A., M.P. Wanielista, H.H. Harper, and J.E. Christopher. (1982). "Management of Drainage Systems from Highway Bridges of Pollution Control." Transportation Research Record 896, Hydrology and Hydraulics: Water, Noise and Air Quality. Washington, D.C.

Yousef, Y.A., M.P. Wanielista, H.H. Harper, D.B. Pearce, and R.D. Tolbert. (1985). "Best Management Practices - Removal of Highway Contaminants by Roadside Swales." Florida Department of Transportation, Publication FL-ER-30-85, Tallahassee, FL.

Yousef, Y.A., M.P. Wanielista, H.H. Harper, and T. Hvitved-Jacobson. (1986). "Best Management Practices - Effectiveness of Retention/Detention Ponds for Control of Contaminants in Highway Runoff." Florida Department of Transportation, Publication FL-ER-34-86, Tallahassee, FL.

APPENDICES

APPENDIX A
PRECIPITATION DATA

- A.1 Summary of Monthly and Annual Precipitation at Florida Monitoring Sites from 1971-2000
- A.2 Geographical Coordinates and Mean Annual Rainfall for Florida Meteorological Monitoring Sites for Available Period of Record
- A.3 Expanded Views of Rainfall Isopleths by Region
- A.4 Frequency Distribution of Rain Events in Selected Meteorological Regions

A.1 Summary of Monthly and Annual Precipitation at Florida Monitoring Sites from 1971-2000



**Monthly Station Normals
of Temperature, Precipitation,
and Heating and Cooling
Degree Days
1971 - 2000**

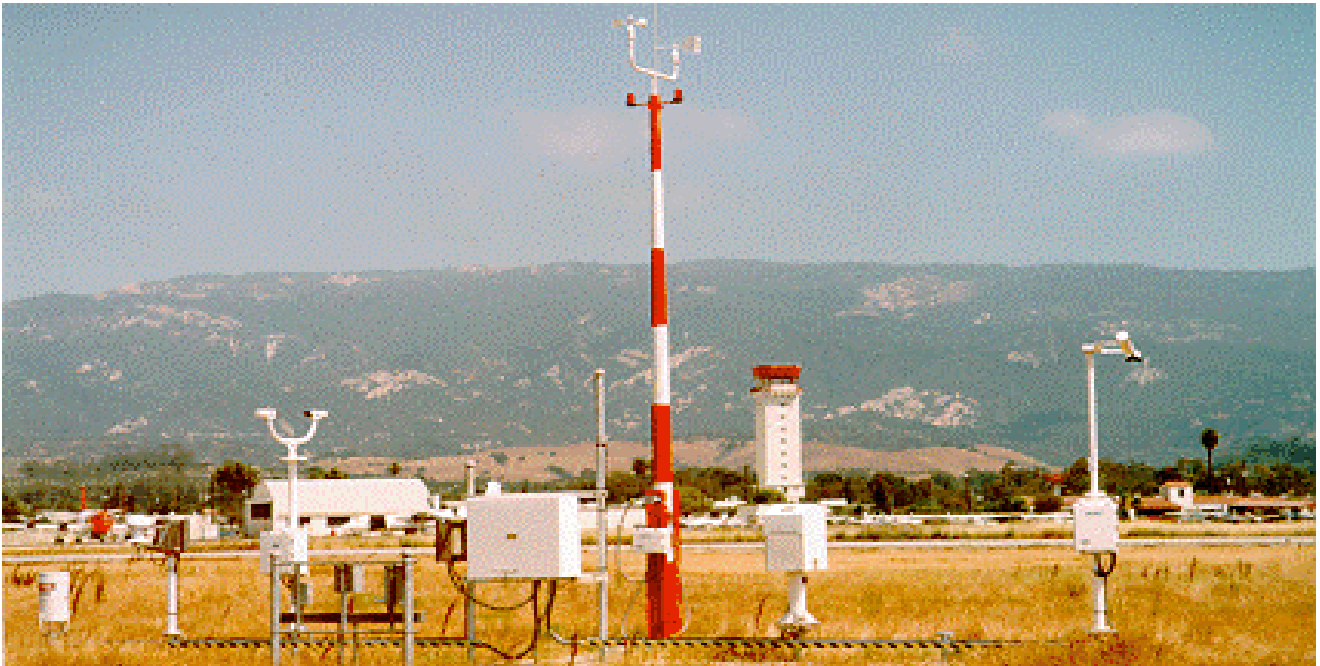

**08
FLORIDA**

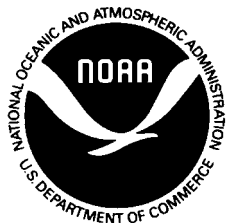

**NATIONAL OCEANIC AND ATMOSPHERIC ADMINISTRATION
NATIONAL ENVIRONMENTAL SATELLITE, DATA, AND INFORMATION SERVICE
NATIONAL CLIMATIC DATA CENTER
ASHEVILLE, NC**

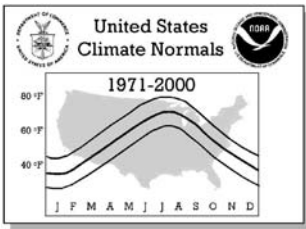

CLIMATOGRAPHY OF THE UNITED STATES NO. 81
Monthly Normals of Temperature, Precipitation, and Heating and Cooling Degree Days
1971-2000

FLORIDA

Page 2

(This Page Intentionally Left Blank)

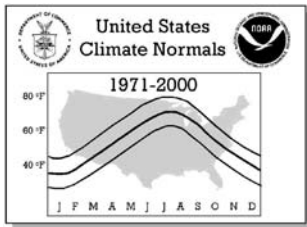

CLIMATOGRAPHY OF THE UNITED STATES NO. 81

Monthly Normals of Temperature, Precipitation, and Heating and Cooling Degree Days 1971-2000

FLORIDA

NOTES

Product Description:

This Climatography includes 1971-2000 normals of monthly and annual maximum, minimum, and mean temperature (degrees F), monthly and annual total precipitation (inches), and heating and cooling degree days (base 65 degrees F). Normals stations include both National Weather Service Cooperative Network and Principal Observation (First-Order) locations in the 50 states, Puerto Rico, the Virgin Islands, and Pacific Islands.

Abbreviations:

- | | |
|---|--|
| <p>No. = Station Number in State Map
 COOP ID = Cooperative Network ID (1:2=State ID, 3:6=Station Index)
 WBAN ID = Weather Bureau Army Navy ID, if assigned
 Elements = Input Elements (X=Maximum Temperature, N=Minimum Temperature, P=Precipitation)
 Call = 3-Letter Station Call Sign, if assigned
 MAX = Normal Maximum Temperature (degrees Fahrenheit)
 MEAN = Average of MAX and MIN (degrees Fahrenheit)
 MIN = Normal Minimum Temperature (degrees Fahrenheit)
 HDD = Total Heating Degree Days (base 65 degrees Fahrenheit)
 CDD = Total Cooling Degree Days (base 65 degrees Fahrenheit)</p> | <p>Latitude = Latitude in degrees, minutes, and hemisphere (N=North, S=South)
 Longitude = Longitude in degrees, minutes, and hemisphere (W=West, E=East)
 Elev = Elevation in feet above mean sea level
 Flag 1 = * if a published <i>Local Climatological Data</i> station
 Flag 2 = + if WMO Fully Qualified (see <i>Note</i> below)
 HIGHEST MEAN/YEAR = Maximum Mean Monthly Value/Year, 1971-2000
 MEDIAN = Median Mean Monthly Value/Year, 1971-2000
 LOWEST MEAN/YEAR = Minimum Mean Monthly Value/Year, 1971-2000
 MAX OBS TIME ADJUSTMENT = Add to MAX to Get Midnight Obs. Schedule
 MIN OBS TIME ADJUSTMENT = Add to MIN to Get Midnight Obs. Schedule</p> |
|---|--|

Note: In 1989, the World Meteorological Organization (WMO) prescribed standards of data completeness for the 1961-1990 WMO Standard Normals. For full qualification, no more than three consecutive year-month values can be missing for a given month or no more than five overall values can be missing for a given month (out of 30 values). Stations meeting these standards are indicated with a '+' sign in Flag 2. Otherwise, stations are included in the normals if they have at least 10 year-month values for each month and have been active since January 1999 or were a previous normals station.

Map Legend: Numbers correspond to 'No.' in Station Inventory; Shaded Circles indicate Temperature and Precipitation Stations, Triangles (Point Up) indicate Precipitation-Only Stations, Triangles (Point Down) indicate Temperature-Only Stations, and Hexagons indicate stations with Flag 1 = *.

Computational Procedures:

A climate normal is defined, by convention, as the arithmetic mean of a climatological element computed over three consecutive decades (WMO, 1989). Ideally, the data record for such a 30-year period should be free of any inconsistencies in observational practices (e.g., changes in station location, instrumentation, time of observation, etc.) and be serially complete (i.e., no missing values). When present, inconsistencies can lead to a non-climatic bias in one period of a station's record relative to another, yielding an "inhomogeneous" data record. Adjustments and estimations can make a climate record "homogeneous" and serially complete, and allow a climate normal to be calculated simply as the average of the 30 monthly values.

The methodology employed to generate the 1971-2000 normals is not the same as in previous normals, as it addresses inhomogeneity and missing data value problems using several steps. The technique developed by Karl *et al.* (1986) is used to adjust monthly maximum and minimum temperature observations of conterminous U.S. stations to a consistent midnight-to-midnight schedule. All monthly temperature averages and precipitation totals are cross-checked against archived daily observations to ensure internal consistency. Each monthly observation is evaluated using a modified quality control procedure (Peterson *et al.*, 1998), where station observation departures are computed, compared with neighboring stations, and then flagged and estimated where large differences with neighboring values exist. Missing or discarded temperature and precipitation observations are replaced using a weighting function derived from the observed relationship between a candidate's monthly observations and those of up to 20 neighboring stations whose observations are most strongly correlated with the candidate site. For temperature estimates, neighboring stations were selected from the U.S. Historical Climatology Network (USHCN; Karl *et al.* 1990). For precipitation estimates, all available stations were potential neighbors, maximizing station density for estimating the more spatially variable precipitation values.

Peterson and Easterling (1994) and Easterling and Peterson (1995) outline the method for adjusting temperature inhomogeneities. This technique involves comparing the record of the candidate station with a reference series generated from neighboring data. The reference series is reconstructed using a weighted average of first difference observations (the difference from one year to the next) for neighboring stations with the highest correlation with the candidate. The underlying assumption behind this methodology is that temperatures over a region have similar tendencies in variation. If this assumption is violated, the potential discontinuity is evaluated for statistical significance. Where significant discontinuities are detected, the difference in average annual temperatures before and after the inhomogeneity is applied to adjust the mean of the earlier block with the mean of the latter block of data. Such an evaluation requires a minimum of five years between discontinuities. Consequently, if multiple changes occur within five years or if a change occurs very near the end of the normals period (e.g., after 1995), the discontinuity may not be detectable using this methodology.

The monthly normals for maximum and minimum temperature and precipitation are computed simply by averaging the appropriate 30 values from the 1971-2000 record. The monthly average temperature normals are computed by averaging the corresponding monthly maximum and minimum normals. The annual temperature normals are calculated by taking the average of the 12 monthly normals. The annual precipitation and degree day normals are the sum of the 12 monthly normals. Trace precipitation totals are shown as zero. Precipitation totals include rain and the liquid equivalent of frozen and freezing precipitation (e.g., snow, sleet, freezing rain, and hail). For many NWS locations, indicated with an '*' next to 'HDD' and 'CDD' in the degree day table, degree day normals are computed directly from daily values for the 1971-2000 period. For all other stations, estimated degree day totals are based on a modification of the rational conversion formula developed by Thom (1966), using daily spline-fit means and standard deviations of average temperature as inputs.

References:

Easterling, D.R., and T.C. Peterson, 1995: *A new method for detecting and adjusting for undocumented discontinuities in climatological time series.* *Intl. J. Clim.*, **15**, 369-377.
 Karl, T.R., C.N. Williams, Jr., P.J. Young, and W.M. Wendland, 1986: *A model to estimate the time of observation bias associated with monthly mean maximum, minimum, and mean temperatures for the United States.* *J. Clim. Appl. Met.*, **25**, 145-160.
 Peterson, T.C., and D.R. Easterling, 1994: *Creation of homogeneous composite climatological reference series.* *Intl. J. Clim.*, **14**, 671-679.
 Peterson, T.C., R. Vose, R. Schmoyer, and V. Razuvaev, 1998: *Global Historical Climatology Network (GHCN) quality control of monthly temperature data.* *Intl. J. Clim.*, **18**, 1169-1179.
 Thom, H.C.S., 1966: *Normal degree days above any base by the universal truncation coefficient.* *Month. Wea. Rev.*, **94**, 461-465.
 World Meteorological Organization, 1989: *Calculation of Monthly and Annual 30-Year Standard Normals*, WCDP-No. 10, WMO-TD/No. 341, Geneva: World Meteorological Organization.

08 - FLORIDA

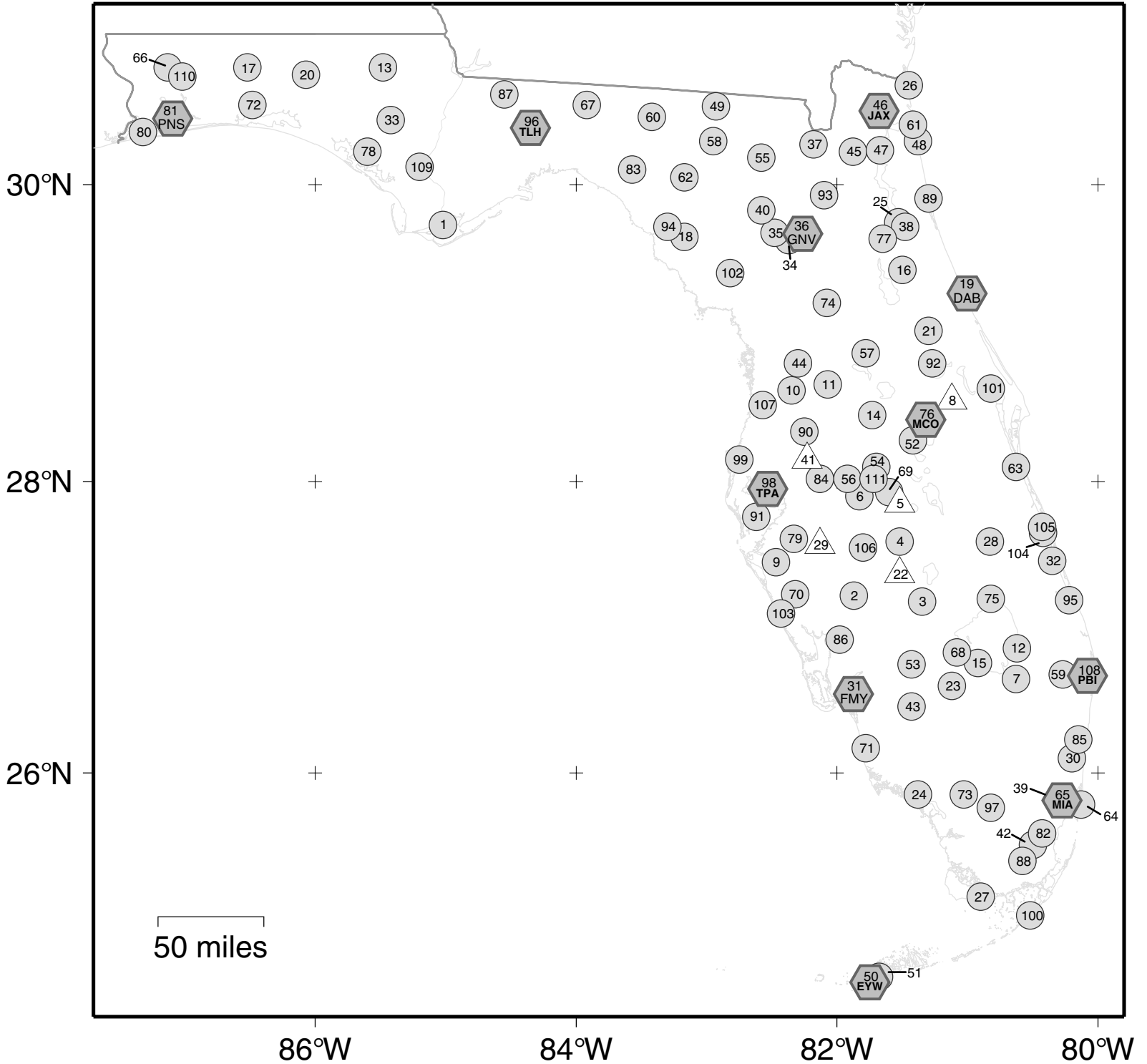

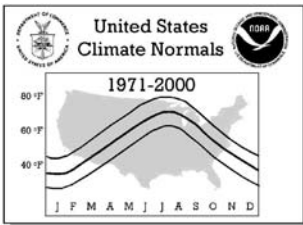

CLIMATOGRAPHY OF THE UNITED STATES NO. 81

Monthly Normals of Temperature, Precipitation, and Heating and Cooling Degree Days 1971-2000

FLORIDA

STATION INVENTORY										
No.	COOP ID	WBAN ID	Elements	Station Name	Call	Latitude	Longitude	Elev	Flag 1	Flag 2
1	080211	12832	XNP	APALACHICOLA AP	AAF	29 44 N	85 01 W	20		+
2	080228		XNP	ARCADIA		27 13 N	81 52 W	30		+
3	080236		XNP	ARCHBOLD BIO STATION		27 11 N	81 21 W	140		+
4	080369		XNP	AVON PARK 2 W		27 36 N	81 32 W	154		+
5	080390		P	BABSON PARK 1 ENE		27 51 N	81 31 W	125		
6	080478		XNP	BARTOW		27 54 N	81 51 W	125		+
7	080611		XNP	BELLE GLADE EXP STN		26 39 N	80 38 W	15		+
8	080758		P	BITHLO		28 33 N	81 07 W	65		
9	080945		XNP	BRADENTON 5 ESE		27 27 N	82 29 W	20		+
10	081046		XNP	BROOKSVILLE CHIN HILL		28 37 N	82 22 W	240		+
11	081163		XNP	BUSHNELL 2 E		28 40 N	82 05 W	75		+
12	081276		XNP	CANAL POINT USDA		26 52 N	80 38 W	30		+
13	081544		XNP	CHIPLEY 3 E		30 47 N	85 29 W	130		+
14	081641		XNP	CLERMONT 7 S		28 27 N	81 45 W	110		+
15	081654		XNP	CLEWISTON US ENGINEERS		26 45 N	80 55 W	20		+
16	081978		XNP	CRESCENT CITY		29 26 N	81 30 W	55		+
17	081986	13884	XNP	CRESTVIEW BOB SIKES AP	CEW	30 47 N	86 31 W	190		
18	082008		XNP	CROSS CITY 2 WNW	CTY	29 39 N	83 10 W	42		+
19	082158	12834	XNP	DAYTONA BEACH INTL AP	DAB	29 11 N	81 03 W	31	*	+
20	082220		XNP	DE FUNIAK SPRINGS		30 44 N	86 04 W	230		+
21	082229		XNP	DELAND 1 SSE		29 01 N	81 19 W	25		+
22	082288		P	DESOTO CITY 8 SW		27 22 N	81 31 W	85		+
23	082298		XNP	DEVILS GARDEN		26 36 N	81 08 W	20		
24	082850		XNP	EVERGLADES		25 51 N	81 23 W	5		
25	082915		XNP	FEDERAL POINT		29 45 N	81 32 W	5		+
26	082944		XNP	FERNANDINA BEACH		30 40 N	81 28 W	13		+
27	083020		XNP	FLAMINGO RANGER STN		25 09 N	80 55 W	3		+
28	083137		XNP	FORT DRUM 5 NW		27 35 N	80 51 W	71		+
29	083153		P	FORT GREEN 12 WSW		27 34 N	82 08 W	112		+
30	083163		XNP	FORT LAUDERDALE	FLL	26 06 N	80 12 W	16		+
31	083186	12835	XNP	FORT MYERS (PAGE AP)	FMY	26 35 N	81 52 W	15	*	+
32	083207		XNP	FORT PIERCE		27 28 N	80 21 W	25		+
33	083230		XNP	FOUNTAIN 3 SSE		30 26 N	85 25 W	140		
34	083321		XNP	GAINESVILLE 3 WSW		29 38 N	82 22 W	96		
35	083322		XNP	GAINESVILLE 11 WNW		29 41 N	82 30 W	95		
36	083326	12816	XNP	GAINESVILLE RGNL AP	GNV	29 42 N	82 17 W	134	*	
37	083470		XNP	GLEN ST MARY 1 W		30 16 N	82 11 W	128		+
38	083874		XNP	HASTINGS ARC		29 43 N	81 30 W	10		
39	083909		XNP	HIALEAH		25 50 N	80 17 W	12		+
40	083956		XNP	HIGH SPRINGS		29 50 N	82 36 W	65		+
41	083986		P	HILLSBOROUGH RVR ST PK		28 09 N	82 14 W	53		
42	084091		XNP	HOMESTEAD EXP STN		25 30 N	80 30 W	11		
43	084210		XNP	IMMOKALEE 3 NNW		26 28 N	81 26 W	35		+
44	084289		XNP	INVERNESS 3 SE		28 48 N	82 19 W	40		+
45	893832	93832	XNP	JACKSONVILLE CECIL NAS		30 13 N	81 53 W	89		+
46	084358	13889	XNP	JACKSONVILLE INTL AP	JAX	30 30 N	81 42 W	26	*	+
47	893837	93837	XNP	JACKSONVILLE NAS		30 14 N	81 40 W	30		+
48	084366		XNP	JACKSONVILLE BEACH		30 17 N	81 24 W	10		
49	084394		XNP	JASPER		30 31 N	82 57 W	147		+
50	084570	12836	XNP	KEY WEST INTL AP	EYW	24 33 N	81 45 W	4	*	+
51	812850	12850	XNP	KEY WEST NAS		24 35 N	81 41 W	23		+
52	084625		XNP	KISSIMMEE 2		28 17 N	81 25 W	60		+
53	084662		XNP	LA BELLE		26 45 N	81 26 W	16		
54	084707		XNP	LAKE ALFRED EXP STN		28 06 N	81 43 W	138		+
55	084731		XNP	LAKE CITY 2 E		30 11 N	82 36 W	195		+
56	084797	12883	XNP	LAKELAND		28 01 N	81 55 W	145		
57	085076		XNP	LISBON		28 52 N	81 47 W	68		+
58	085099		XNP	LIVE OAK		30 17 N	82 58 W	120		+
59	085182		XNP	LOXAHATCHEE		26 41 N	80 16 W	14		
60	085275		XNP	MADISON		30 27 N	83 25 W	120		
61	803853	03853	XNP	MAYPORT PILOT STN		30 24 N	81 25 W	16		
62	085539		XNP	MAYO		30 03 N	83 10 W	65		+
63	085612	12838	XNP	MELBOURNE WFO	MLB	28 06 N	80 39 W	25		+
64	085658	12859	XNP	MIAMI BEACH		25 47 N	80 08 W	5		+
65	085663	12839	XNP	MIAMI INTL AP	MIA	25 49 N	80 18 W	35	*	+
66	085793		XNP	MILTON EXPERIMENT STN		30 47 N	87 08 W	217		+
67	085879		XNP	MONTICELLO 3 W		30 32 N	83 55 W	145		+
68	085895		XNP	MOORE HAVEN LOCK 1		26 50 N	81 05 W	35		+
69	085973		XNP	MOUNTAIN LAKE		27 56 N	81 36 W	125		+
70	086065		XNP	MYAKKA RIVER STATE PARK		27 14 N	82 19 W	20		+

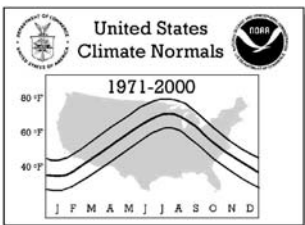

CLIMATOGRAPHY OF THE UNITED STATES NO. 81

Monthly Normals of Temperature, Precipitation, and Heating and Cooling Degree Days 1971-2000

STATION INVENTORY										
No.	COOP ID	WBAN ID	Elements	Station Name	Call	Latitude	Longitude	Elev	Flag 1	Flag 2
71	086078		XNP	NAPLES		26 10 N	81 47 W	5		+
72	086240		XNP	NICEVILLE		30 32 N	86 30 W	60		
73	086406		XNP	OASIS RANGER STN		25 51 N	81 02 W	8		
74	086414		XNP	OCALA		29 12 N	82 05 W	75		+
75	086485		XNP	OKEECHOBEE		27 12 N	80 50 W	21		
76	086628	12815	XNP	ORLANDO INTL AP	MCO	28 26 N	81 20 W	96	*	+
77	086753		XNP	PALATKA		29 39 N	81 40 W	70		
78	086842		XNP	PANAMA CITY 5 NE	PFN	30 13 N	85 36 W	32		+
79	086880		XNP	PARRISH		27 37 N	82 21 W	60		+
80	803855	03855	XNP	PENSACOLA SHERMAN NAS		30 21 N	87 19 W	33		+
81	086997	13899	XNP	PENSACOLA RGNL AP	PNS	30 29 N	87 11 W	112	*	+
82	087020		XNP	PERRINE 4 W		25 35 N	80 26 W	10		
83	087025		XNP	PERRY		30 06 N	83 34 W	45		+
84	087205		XNP	PLANT CITY		28 01 N	82 08 W	120		+
85	087254		XNP	POMPAÑO BEACH		26 14 N	80 09 W	15		+
86	087397		XNP	PUNTA GORDA 4 ESE		26 55 N	82 00 W	20		+
87	087429		XNP	QUINCY 3 SSW		30 36 N	84 33 W	245		+
88	087760		XNP	ROYAL PALM RANGER STN		25 23 N	80 36 W	7		
89	087826		XNP	ST AUGUSTINE WFOY		29 55 N	81 19 W	8		+
90	087851		XNP	SAINT LEO		28 20 N	82 16 W	190		+
91	087886		XNP	ST PETERSBURG	SPG	27 46 N	82 38 W	8		+
92	087982		XNP	SANFORD ORLANDO	SFB	28 48 N	81 16 W	12		+
93	088527		XNP	STARKE		29 56 N	82 06 W	162		
94	088565		XNP	STEINHATCHEE 6 ENE		29 43 N	83 18 W	35		+
95	088620		XNP	STUART 1 S		27 11 N	80 14 W	10		+
96	088758	93805	XNP	TALLAHASSEE MUNICIPAL AP	TLH	30 24 N	84 21 W	55	*	+
97	088780		XNP	TAMIAMI TRAIL 40 MI BEND		25 46 N	80 49 W	15		+
98	088788	12842	XNP	TAMPA INTL AP	TPA	27 58 N	82 32 W	19	*	+
99	088824		XNP	TARPOON SPRINGS SWG PLNT		28 09 N	82 45 W	8		+
100	088841		XNP	TAVERNIER		25 00 N	80 31 W	7		+
101	088942		XNP	TITUSVILLE		28 38 N	80 50 W	5		+
102	089120		XNP	USHER TOWER		29 25 N	82 49 W	33		+
103	089176		XNP	VENICE		27 06 N	82 26 W	8		
104	089214	12843	XNP	VERO BEACH MUNI ARPT		27 39 N	80 25 W	24		
105	089219		XNP	VERO BEACH 4 W		27 41 N	80 26 W	20		+
106	089401		XNP	WAUCHULA		27 33 N	81 48 W	60		+
107	089430		XNP	WEEKI WACHEE		28 31 N	82 35 W	20		+
108	089525	12844	XNP	WEST PALM BEACH INTL AP	PBI	26 41 N	80 06 W	18	*	+
109	089566		XNP	WEWAHITCHKA		30 07 N	85 12 W	42		+
110	893841	93841	XNP	WHITING FIELD NAS		30 43 N	87 01 W	177		+
111	089707		XNP	WINTER HAVEN		28 01 N	81 44 W	145		+

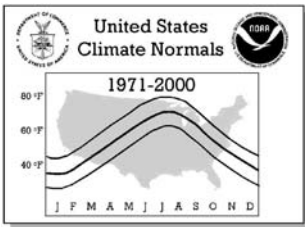

CLIMATOGRAPHY OF THE UNITED STATES NO. 81

Monthly Normals of Temperature, Precipitation, and Heating and Cooling Degree Days 1971-2000

FLORIDA

No.	Station Name	PRECIPITATION NORMALS (Total in Inches)												
		JAN	FEB	MAR	APR	MAY	JUN	JUL	AUG	SEP	OCT	NOV	DEC	ANNUAL
001	APALACHICOLA AP	4.87	3.76	4.95	3.00	2.62	4.30	7.31	7.29	7.10	4.18	3.62	3.51	56.51
002	ARCADIA	2.13	2.43	3.10	1.86	3.87	7.81	7.64	7.02	6.77	2.87	2.08	1.76	49.34
003	ARCHBOLD BIO STATION	2.32	2.38	3.25	2.33	3.98	7.74	7.66	7.42	6.50	3.00	2.07	1.95	50.60
004	AVON PARK 2 W	2.48	2.41	3.02	2.17	3.63	8.25	6.81	7.18	5.98	3.02	2.27	1.87	49.09
005	BABSON PARK 1 ENE	2.06	2.56	3.13	1.95	4.10	6.86	8.23	7.29	5.65	2.29	2.48	1.75	48.35
006	BARTOW	2.51	2.82	3.11	2.53	3.81	6.78	8.56	6.52	6.68	2.71	2.18	2.37	50.58
007	BELLE GLADE EXP STN	2.51	1.88	2.65	2.41	5.04	7.33	7.34	7.16	7.09	3.54	2.79	1.82	51.56
008	BITHLO	2.35	2.69	2.81	1.88	3.47	7.26	6.86	8.06	6.14	3.75	2.14	1.87	49.28
009	BRADENTON 5 ESE	2.94	2.66	3.36	1.83	2.85	7.41	8.71	9.43	7.25	2.88	2.35	2.45	54.12
010	BROOKSVILLE CHIN HILL	3.27	3.24	4.22	2.62	3.40	7.24	7.16	8.24	5.96	2.38	2.39	2.45	52.57
011	BUSHNELL 2 E	3.43	3.02	3.93	2.34	3.79	6.18	6.43	7.24	6.00	2.14	2.18	2.52	49.20
012	CANAL POINT USDA	2.60	2.27	3.44	2.42	4.61	7.64	6.22	6.69	7.28	3.91	2.95	2.07	52.10
013	CHIPLEY 3 E	6.09	4.81	6.11	3.84	4.21	5.24	6.92	5.38	4.76	2.90	4.12	3.86	58.24
014	CLERMONT 7 S	3.11	2.58	3.81	2.18	3.67	7.86	6.78	6.96	5.59	2.40	2.40	2.40	49.74
015	CLEWISTON US ENGINEERS	2.38	2.01	2.68	2.16	4.50	7.15	6.58	6.28	4.99	2.87	2.28	1.52	45.40
016	CRESCENT CITY	3.34	2.83	4.06	2.56	3.52	6.53	6.34	6.28	6.11	3.12	2.55	2.55	49.79
017	CRESTVIEW BOB SIKES AP	6.49	4.91	7.06	4.26	4.94	7.41	6.83	6.34	4.88	3.02	4.20	3.60	63.94
018	CROSS CITY 2 WNW	4.41	3.54	4.42	3.48	3.06	6.34	8.92	9.67	6.10	2.93	2.35	3.27	58.49
019	DAYTONA BEACH INTL AP	3.13	2.74	3.84	2.54	3.26	5.69	5.17	6.09	6.61	4.48	3.03	2.71	49.29
020	DE FUNIAK SPRINGS	5.61	5.39	6.23	3.93	4.95	6.60	7.67	6.77	6.03	3.23	4.76	4.35	65.52
021	DELAND 1 SSE	3.35	2.96	3.84	2.80	4.27	7.60	7.88	7.70	7.17	4.09	2.72	2.65	57.03
022	DESOTO CITY 8 SW	2.31	2.57	3.10	2.20	3.61	8.21	7.00	6.97	6.48	2.64	2.30	1.62	49.01
023	DEVILS GARDEN	2.37	2.09	2.78	2.63	4.33	8.58	7.52	8.10	6.53	3.52	2.58	1.64	52.67
024	EVERGLADES	1.71	1.49	1.92	1.93	3.56	9.89	7.34	8.62	8.23	3.80	1.89	1.72	52.10
025	FEDERAL POINT	3.09	2.89	3.68	2.34	3.55	6.67	6.16	6.57	6.83	3.34	2.70	2.72	50.54
026	FERNANDINA BEACH	3.82	3.17	4.01	2.91	2.87	5.30	5.80	5.34	7.73	4.22	2.49	2.73	50.39
027	FLAMINGO RANGER STN	1.94	1.63	1.87	2.06	5.06	7.25	4.73	7.43	7.20	4.26	2.46	1.57	47.46
028	FORT DRUM 5 NW	2.27	2.47	3.78	2.43	4.47	8.05	7.60	7.27	6.60	3.73	2.30	1.86	52.83
029	FORT GREEN 12 WSW	2.43	2.62	3.31	2.09	3.42	8.18	8.29	7.78	6.86	2.62	2.13	2.23	51.96
030	FORT LAUDERDALE	2.94	2.70	2.80	3.91	6.33	10.01	6.70	6.88	8.26	6.44	4.57	2.65	64.19
031	FORT MYERS (PAGE AP)	2.23	2.10	2.74	1.67	3.42	9.77	8.98	9.54	7.86	2.59	1.71	1.58	54.19
032	FORT PIERCE	2.70	2.99	3.27	2.77	4.38	5.84	5.79	6.35	7.81	5.82	3.50	2.28	53.50
033	FOUNTAIN 3 SSE	5.83	4.69	6.38	3.05	4.39	7.20	8.00	6.50	6.61	2.95	4.01	4.41	64.02
034	GAINESVILLE 3 WSW	4.13	3.90	3.94	3.03	3.70	5.87	5.34	6.69	5.33	1.89	2.58	3.05	49.45
035	GAINESVILLE 11 WNW	3.95	2.34	4.31	2.92	3.34	6.20	7.50	7.89	4.05	2.99	1.87	2.20	49.56
036	GAINESVILLE RGNL AP	3.51	3.39	4.26	2.86	3.23	6.78	6.10	6.63	4.37	2.50	2.17	2.56	48.36
037	GLEN ST MARY 1 W	4.34	3.41	4.52	3.29	3.58	6.53	6.33	7.33	5.36	3.10	2.23	2.92	52.94
038	HASTINGS ARC	3.39	2.69	3.94	2.72	3.47	6.98	5.56	6.37	7.40	3.94	2.88	2.65	51.99
039	HIALEAH	2.34	2.22	3.20	3.90	6.08	10.24	7.00	9.20	8.88	6.56	3.83	2.59	66.04
040	HIGH SPRINGS	4.35	3.69	4.33	3.28	3.63	6.88	7.53	7.92	4.56	2.96	2.28	2.74	54.15
041	HILLSBOROUGH RVR ST PK	3.35	3.12	3.41	2.23	3.21	7.87	7.27	8.16	7.23	2.71	2.72	3.28	54.56
042	HOMESTEAD EXP STN	1.94	1.78	1.88	2.74	5.77	9.51	6.82	9.16	8.90	5.49	2.59	1.61	58.19
043	IMMOKALEE 3 NNW	2.33	2.26	2.97	2.36	4.08	7.78	7.27	7.49	6.61	2.88	2.27	1.77	50.07
044	INVERNESS 3 SE	3.55	2.96	4.17	2.40	3.33	7.40	7.05	7.52	5.93	2.63	2.27	2.56	51.77
045	JACKSONVILLE CECIL NAS	3.50	3.20	4.16	2.91	3.25	6.54	6.39	7.07	6.69	3.24	2.28	2.65	51.88
046	JACKSONVILLE INTL AP	3.69	3.15	3.93	3.14	3.48	5.37	5.97	6.87	7.90	3.86	2.34	2.64	52.34
047	JACKSONVILLE NAS	3.39	2.59	3.97	2.77	3.22	5.78	5.99	5.87	7.28	3.30	2.35	2.45	48.96
048	JACKSONVILLE BEACH	3.56	2.84	3.92	2.87	3.03	5.70	5.21	6.11	7.53	5.04	2.36	2.75	50.92
049	JASPER	4.96	4.13	5.16	3.45	3.33	6.03	5.62	6.27	4.20	2.87	2.79	3.43	52.24
050	KEY WEST INTL AP	2.22	1.51	1.86	2.06	3.48	4.57	3.27	5.40	5.45	4.34	2.64	2.14	38.94
051	KEY WEST NAS	2.50	1.65	1.80	2.12	3.88	5.42	4.11	5.48	6.33	4.58	2.62	2.24	42.73
052	KISSIMEE 2	2.39	2.72	3.32	2.02	3.83	6.02	6.55	7.32	6.01	3.17	2.42	2.24	48.01
053	LA BELLE	2.31	2.16	2.89	2.29	3.91	8.88	7.69	7.78	6.57	3.35	2.34	1.71	51.88
054	LAKE ALFRED EXP STN	2.52	2.75	3.43	1.99	4.12	6.88	7.11	7.43	6.53	2.96	2.29	2.28	50.29
055	LAKE CITY 2 E	4.52	3.61	4.90	3.15	3.71	6.91	6.74	7.19	4.67	2.82	2.42	2.96	53.60
056	LAKELAND	2.45	2.73	3.38	2.04	3.81	7.00	7.51	7.33	6.33	2.29	2.12	2.14	49.13
057	LISBON	3.32	2.87	4.03	2.80	4.13	6.13	5.67	6.20	5.76	2.54	2.53	2.65	48.63
058	LIVE OAK	4.99	4.01	5.33	3.29	3.23	6.06	6.35	6.13	4.64	3.26	2.43	3.11	52.83
059	LOXAHATCHEE	2.99	2.23	2.97	2.27	5.33	8.84	7.30	5.58	9.25	5.18	4.44	2.06	58.44
060	MADISON	5.50	4.11	5.59	3.22	3.10	5.82	6.18	5.38	3.94	2.96	3.31	4.07	53.18
061	MAYPORT PILOT STN	2.70	2.58	3.23	2.41	2.13	4.06	4.21	4.45	7.15	4.16	1.74	2.20	41.02
062	MAYO	4.88	3.66	4.85	3.07	3.19	5.82	7.60	7.97	5.07	3.01	2.52	3.23	54.87
063	MELBOURNE WFO	2.48	2.49	2.92	2.08	3.94	5.83	5.38	5.78	7.20	4.76	3.12	2.31	48.29
064	MIAMI BEACH	2.44	2.14	2.20	2.81	4.90	6.90	3.63	5.44	6.31	4.53	3.32	1.98	46.60
065	MIAMI INTL AP	1.88	2.07	2.56	3.36	5.52	8.54	5.79	8.63	8.38	6.19	3.43	2.18	58.53
066	MILTON EXPERIMENT STN	6.39	5.04	7.32	4.35	4.83	7.11	8.17	6.62	6.12	3.66	5.47	4.40	69.48
067	MONTICELLO 3 W	5.63	4.64	6.00	3.63	4.03	5.60	6.50	6.73	4.70	3.32	3.63	3.90	58.31
068	MOORE HAVEN LOCK 1	2.04	2.05	2.93	2.35	3.70	6.98	6.67	6.80	6.42	2.95	1.91	1.64	46.44
069	MOUNTAIN LAKE	2.38	2.43	3.12	2.02	3.88	7.12	7.45	6.64	5.83	2.50	2.23	2.10	47.70

**A.2 Geographical Coordinates and Mean Annual Rainfall for Florida
Meteorological Monitoring Sites for Available Period of Record**

ID	STATION	Latitude	Longitude	Rainfall (inches)
80211	APALACHICOLA AP	29.73	85.02	56.51
80228	ARCADIA	27.22	81.87	49.34
80236	ARCHBOLD BIO STATION	27.18	81.35	50.60
80369	AVON PARK 2 W	27.60	81.53	49.09
80390	BABSON PARK 1 ENE	27.85	81.52	48.35
80478	BARTOW	27.90	81.85	50.58
80611	BELLE GLADE EXP STN	26.65	80.63	51.56
80758	BITHLO	28.55	81.12	49.28
80945	BRADENTON 5 ESE	27.45	82.48	54.12
81046	BROOKSVILLE CHIN HILL	28.62	82.37	52.57
81163	BUSHNELL 2 E	28.67	82.08	49.20
81276	CANAL POINT USDA	26.87	80.63	52.10
81544	CHIPLEY 3 E	30.78	85.48	58.24
81641	CLERMONT 7 S	28.45	81.75	49.74
81654	CLEWISTON US ENGINEERS	26.75	80.92	45.40
81978	CRESCENT CITY	29.43	81.50	49.79
81986	CRESTVIEW BOB SIKES AP	30.78	86.52	63.94
82008	CROSS CITY 2 WNW	29.65	83.17	58.49
82158	DAYTONA BEACH INTL AP	29.18	81.05	49.29
82220	DE FUNIAK SPRINGS	30.73	86.07	65.52
82229	DELAND 1 SSE	29.02	81.32	57.03
82288	DESOTO CITY 8 SW	27.37	81.52	49.01
82298	DEVILS GARDEN	26.60	81.13	52.67
82850	EVERGLADES	25.85	81.38	52.10
82915	FEDERAL POINT	29.75	81.53	50.54
82944	FERNANDINA BEACH	30.67	81.47	50.39
83020	FLAMINGO RANGER STN	25.15	80.92	47.46
83137	FORT DRUM 5 NW	27.58	80.85	52.83
83153	FORT GREEN 12 WSW	27.57	82.13	51.96
83163	FORT LAUDERDALE	26.10	80.20	64.19
83186	FORT MYERS (PAGE AP)	26.58	81.87	54.19
83207	FORT PIERCE	27.47	80.35	53.50
83230	FOUNTAIN 3 SSE	30.43	85.42	64.02
83321	GAINESVILLE 3 WSW	29.63	82.37	49.45
83322	GAINESVILLE 11 WNW	29.68	82.50	49.56
83326	GAINESVILLE RGNL AP	29.70	82.28	48.36
83470	GLEN ST MARY 1 W	30.27	82.18	52.94
83874	HASTINGS ARC	29.72	81.50	51.99
83909	HIALEAH	25.83	80.28	66.04
83956	HIGH SPRINGS	29.83	82.60	54.15
83986	HILLSBOROUGH RVR ST PK	28.15	82.23	54.56
84091	HOMESTEAD EXP STN	25.50	80.50	58.19
84210	IMMOKALEE 3 NNW	26.47	81.43	50.07
84289	INVERNESS 3 SE	28.80	82.32	51.77
893832	JACKSONVILLE CECIL NAS	30.22	81.88	51.88
84358	JACKSONVILLE INTL AP	30.50	81.70	52.34
893837	JACKSONVILLE NAS	30.23	81.67	48.96
84366	JACKSONVILLE BEACH	30.28	81.40	50.92
84394	JASPER	30.52	82.95	52.24
84570	KEY WEST INTL AP	24.55	81.75	38.94
812850	KEY WEST NAS	24.58	81.68	42.73
84625	KISSIMMEE 2	28.28	81.42	48.01
84662	LA BELLE	26.75	81.43	51.88
84707	LAKE ALFRED EXP STN	28.10	81.72	50.29

ID	STATION	Latitude	Longitude	Rainfall (inches)
84731	LAKE CITY 2 E	30.18	82.60	53.60
84797	LAKELAND	28.02	81.92	49.13
85076	LISBON	28.87	81.78	48.63
85099	LIVE OAK	30.28	82.97	52.83
85182	LOXAHATCHEE	26.68	80.27	58.44
85275	MADISON	30.45	83.42	53.18
803853	MAYPORT PILOT STN	30.40	81.42	41.02
85539	MAYO	30.05	83.17	54.87
85612	MELBOURNE WFO	28.10	80.65	48.29
85658	MIAMI BEACH	25.78	80.13	46.60
85663	MIAMI INTL AP	25.82	80.30	58.53
85793	MILTON EXPERIMENT STN	30.78	87.13	69.48
85879	MONTICELLO 3 W	30.53	83.92	58.31
85895	MOORE HAVEN LOCK 1	26.83	81.08	46.44
85973	MOUNTAIN LAKE	27.93	81.60	47.70
86065	MYAKKA RIVER STATE PARK	27.23	82.32	58.91
86078	NAPLES	26.17	81.78	51.90
86240	NICEVILLE	30.53	86.50	69.20
86406	OASIS RANGER STN	25.85	81.03	58.82
86414	OCALA	29.20	82.08	49.68
86485	OKEECHOBEE	27.20	80.83	45.66
86628	ORLANDO INTL AP	28.43	81.33	48.35
86753	PALATKA	29.65	81.67	50.42
86842	PANAMA CITY 5 NE	30.22	85.60	64.76
86880	PARRISH	27.62	82.35	52.09
803855	PENSACOLA SHERMAN NAS	30.35	87.32	63.11
86997	PENSACOLA RGNL AP	30.48	87.18	64.28
87020	PERRINE 4 W	25.58	80.43	61.56
87025	PERRY	30.10	83.57	57.68
87205	PLANT CITY	28.02	82.13	51.17
87254	POMPANO BEACH	26.23	80.15	57.27
87397	PUNTA GORDA 4 ESE	26.92	82.00	49.68
87429	QUINCY 3 SSW	30.60	84.55	56.34
87760	ROYAL PALM RANGER STN	25.38	80.60	55.55
87826	ST AUGUSTINE WFOY	29.92	81.32	47.42
87851	SAINT LEO	28.33	82.27	53.84
87886	ST PETERSBURG	27.77	82.63	49.58
87982	SANFORD ORLANDO	28.80	81.27	51.31
88527	STARKE	29.93	82.10	50.34
88565	STEINHATCHEE 6 ENE	29.72	83.30	59.61
88620	STUART 1 S	27.18	80.23	59.53
88758	TALLAHASSEE MUNICIPAL A	#N/A	#N/A	63.21
88780	TAMIAMI TRAIL 40 MI BEN	#N/A	#N/A	51.55
88788	TAMPA INTL AP	27.97	82.53	44.77
88824	TARPON SPRINGS SWG PLNT	28.15	82.75	52.42
88841	TAVERNIER	25.00	80.52	44.82
88942	TITUSVILLE	28.63	80.83	52.79
89120	USHER TOWER	29.42	82.82	59.65
89176	VENICE	27.10	82.43	48.77
89214	VERO BEACH MUNI ARPT	27.65	80.42	51.93
89219	VERO BEACH 4 W	27.68	80.43	55.58
89401	WAUCHULA	27.55	81.80	50.44
89430	WEEKI WACHEE	28.52	82.58	51.56
89525	WEST PALM BEACH INTL AP	26.68	80.10	61.39

ID	STATION	Latitude	Longitude	Rainfall (inches)
89566	WEWAHITCHKA	30.12	85.20	63.66
893841	WHITING FIELD NAS	30.72	87.02	67.32
89707	WINTER HAVEN	28.02	81.73	50.22
90140	ALBANY 3 SE	31.53	84.13	53.40
90211	ALMA BACON COUNTY AP	31.53	82.50	49.13
90441	ATKINSON 2 W	31.23	81.87	52.72
90586	BAINBRIDGE INTL PAPER C	#N/A	#N/A	55.47
90979	BLAKELY	31.37	84.95	54.52
91340	BRUNSWICK	31.17	81.50	49.42
91345	BRUNSWICK MCKINNON AP	31.15	81.38	48.27
91463	CAIRO 2 N	30.90	84.22	49.61
91500	CAMILLA 3 SE	31.18	84.20	52.88
92153	COLQUITT 2 W	31.17	84.77	53.19
92736	DONALSONVILLE 1 S	31.02	84.88	54.73
92783	DOUGLAS	31.52	82.85	52.03
93325	FARGO 17 NE	30.83	82.37	45.07
93460	FOLKSTON 3 SW	30.80	82.02	50.08
93465	FOLKSTON 9 SW	30.73	82.13	52.56
94429	HOMERVILLE 5 N	31.08	82.80	52.84
94676	JESUP 8 S	31.50	81.87	48.70
96087	MOULTRIE 2 ESE	31.17	83.75	50.93
96219	NAHUNTA 3 E	31.22	81.93	51.80
96244	NASHVILLE 4 N	31.25	83.22	44.84
96838	PATTERSON	31.38	82.13	48.89
97276	QUITMAN 2 NW	30.80	83.58	53.06
97808	SAPELO ISLAND	31.40	81.28	51.84
98666	THOMASVILLE 3 NE	30.88	83.93	54.07
98703	TIFTON EXP STA	31.50	83.53	46.99
99186	WAYCROSS 4 NE	31.25	82.32	50.44
99192	WAYCROSS WSMO	31.25	82.40	47.31
161157	BOOTHVILLE	29.35	89.40	59.95
161292	BURAS	29.33	89.52	59.83
10252	ANDALUSIA 3 W	31.30	86.52	61.89
10402	ATMORE STATE NURSERY	31.17	87.43	64.52
10583	BAY MINETTE	30.88	87.78	67.64
11080	BREWTON 3 ENE	31.13	87.05	68.62
11084	BREWTON 3 SSE	31.05	87.05	66.12
11566	CHATOM	31.47	88.25	63.92
11803	CODEN	30.38	88.23	64.14
12172	DAUPHIN ISLAND #2	30.25	88.08	64.25
12577	ELBA	31.42	86.07	59.37
12675	ENTERPRISE 5 NNW	31.38	85.90	56.88
12758	EVERGREEN	31.45	86.95	64.07
12813	FAIRHOPE 2 NE	30.55	87.88	67.71
13105	FRISCO CITY 3 SSW	31.38	87.42	60.78
13251	GENEVA NO 2	31.05	85.88	58.98
13761	HEADLAND	31.35	85.33	56.61
84394	JASPER	30.52	82.95	52.24
14431	KINSTON	31.23	86.18	60.14
15478	MOBILE RGNL AP	30.68	88.25	66.29
16988	ROBERTSDALE 5 NE	30.63	87.65	67.92
18637	WALLACE 2 E	31.22	87.18	65.71

A.3 Expanded Views of Rainfall Isopleths by Region

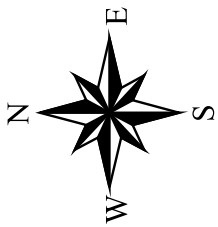
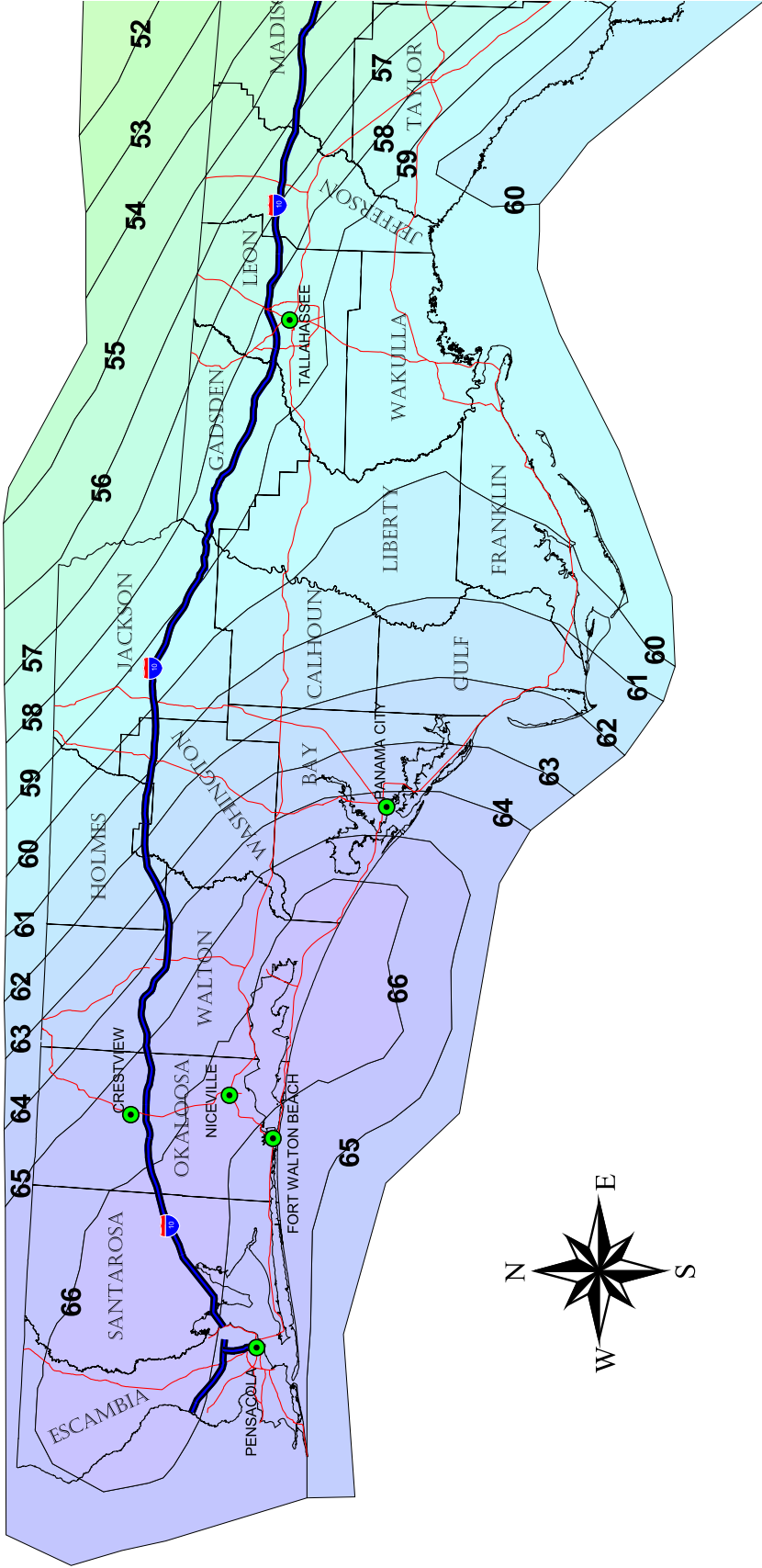

- CITIES
- INTERSTATE
- PRINCIPAL ARTERIAL
- OTHER FREEWAYS AND EXPRESSWAYS

20 0 20 40 Miles



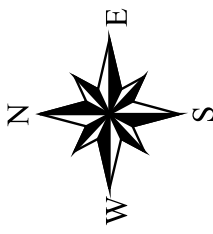
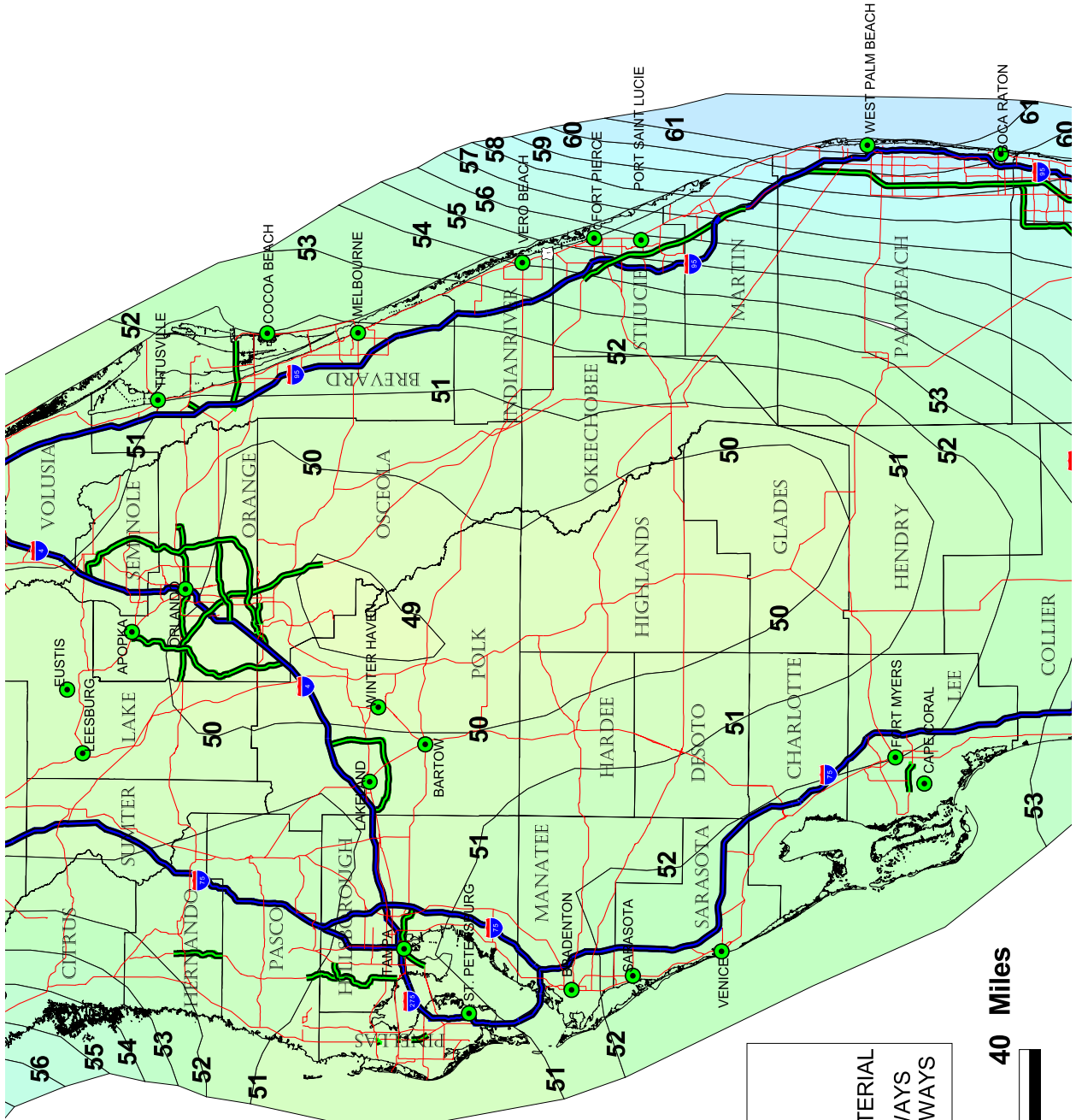

- CITIES
- INTERSTATE
- PRINCIPAL ARTERIAL
- OTHER FREEWAYS AND EXPRESSWAYS



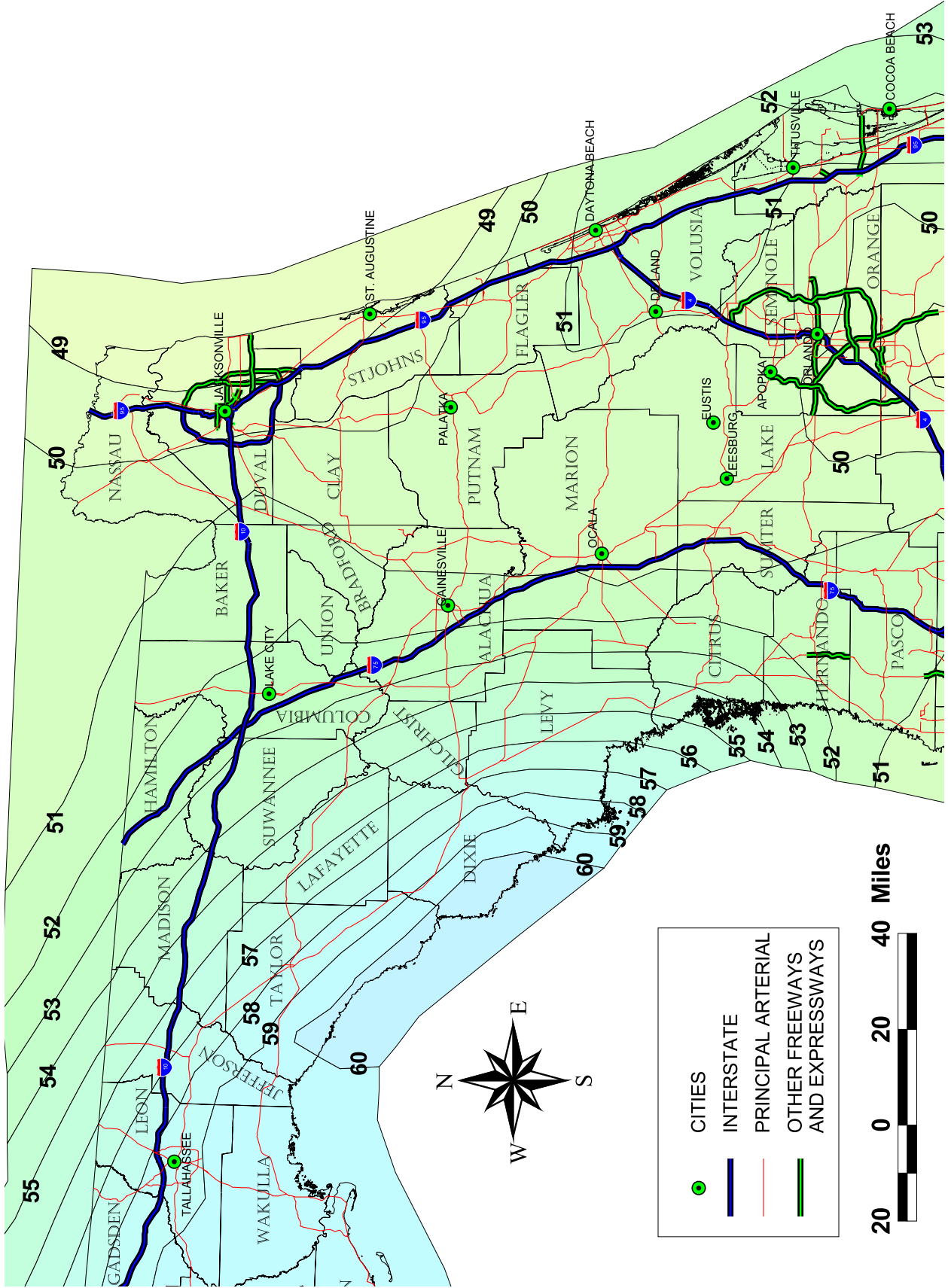

- CITIES
- INTERSTATE
- PRINCIPAL ARTERIAL
- OTHER FREEWAYS AND EXPRESSWAYS



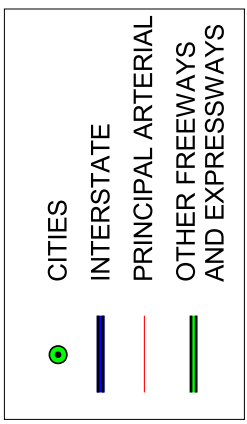
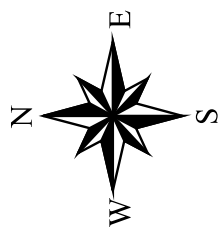
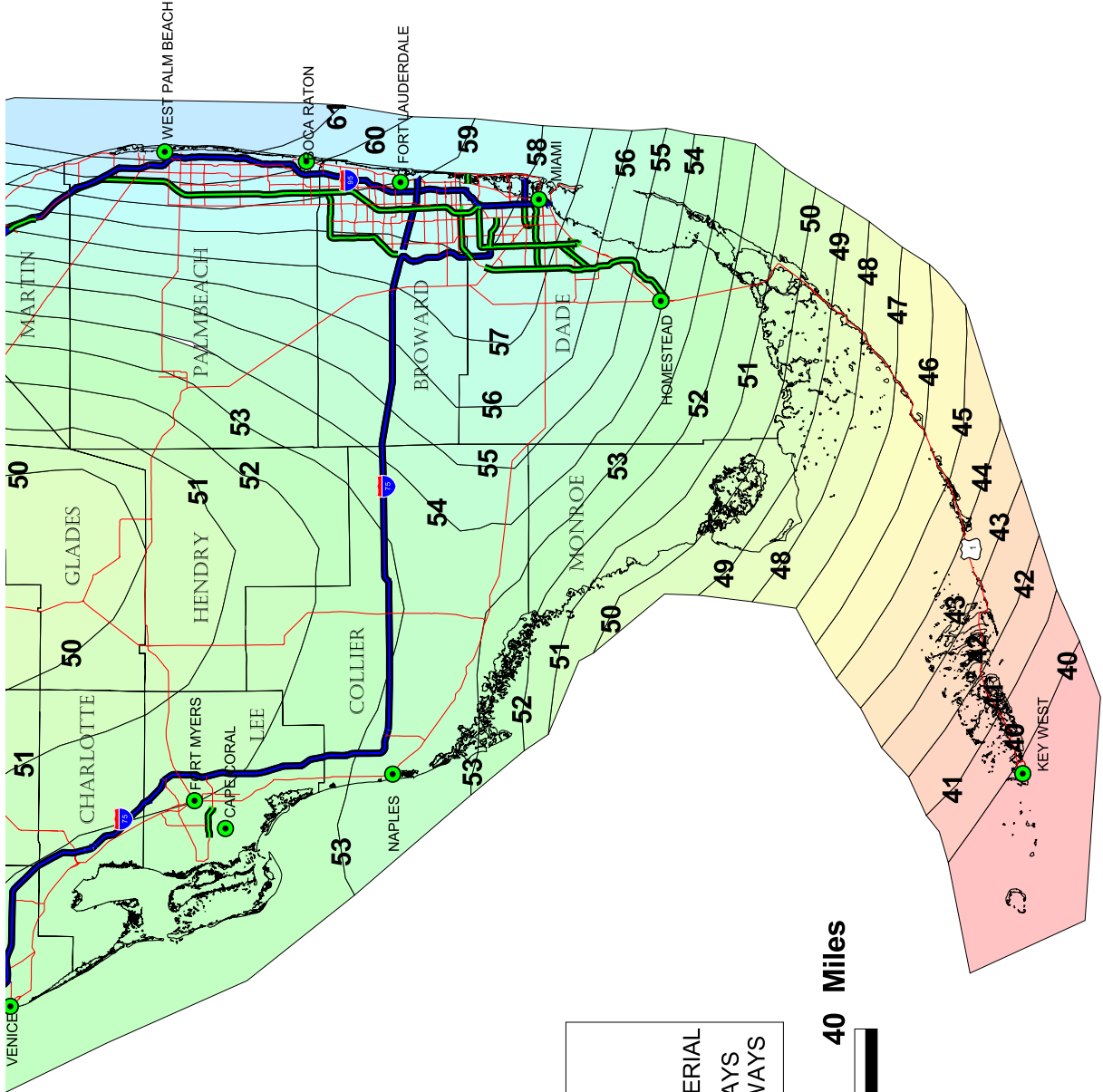

A.4 Frequency Distribution of Rain Events in Selected Meteorological Regions

PENSACOLA REGIONAL AP (6997)

from 1942 to 2005 (n=33)

(minimum number of months per year at site =9)

Rainfall Event Range (in)	Number of Annual Events in Range	Mean Rainfall Depth (in)	Mean Rainfall Duration (hr)	Antecedent Dry Period (days)	Annual Event Volume	Cumulative Annual Event Volume (inches)	Cumulative Percent of Total Rainfall
0.00-0.10	57.67	0.035	1.0	62.2	2.02	2.02	3.24
0.11-0.20	15.36	0.152	2.0	68.5	2.34	4.36	7.01
0.21-0.30	8.24	0.250	2.6	62.6	2.06	6.42	10.32
0.31-0.40	5.61	0.354	3.9	74.2	1.98	8.40	13.51
0.41-0.50	4.97	0.453	4.2	81.2	2.25	10.65	17.13
0.51-1.00	15.42	0.711	5.4	71.5	10.96	21.61	34.76
1.01-1.50	8.06	1.219	8.2	66.1	9.82	31.43	50.56
1.51-2.00	4.18	1.720	11.2	66.8	7.19	38.63	62.13
2.01-2.50	2.45	2.215	13.3	59.3	5.44	44.07	70.88
2.51-3.00	1.36	2.745	14.2	56.0	3.74	47.81	76.90
3.01-3.50	0.73	3.192	17.2	75.0	2.32	50.13	80.63
3.51-4.00	0.42	3.757	19.4	61.1	1.59	51.72	83.20
4.01-4.50	0.55	4.216	18.1	82.5	2.30	54.02	86.89
4.51-5.00	0.27	4.682	17.8	36.4	1.28	55.30	88.95
5.01-5.50	0.18	5.308	22.2	66.0	0.97	56.27	90.50
5.51-6.00	0.15	5.736	25.8	43.8	0.87	57.14	91.90
6.01-6.50	0.03	6.450	57.0	18.0	0.20	57.33	92.21
6.51-7.00	0.12	6.745	34.0	109.5	0.82	58.15	93.53
7.01-7.50	0.15	7.332	22.6	51.2	1.11	59.26	95.32
7.51-8.00	0.06	7.765	32.5	64.5	0.47	59.73	96.07
8.01-8.50	0.03	8.450	43.0	6.0	0.26	59.99	96.48
8.51-9.00	0.03	8.710	52.0	64.0	0.26	60.25	96.91
>9.00	0.18	10.572	35.3	76.3	1.92	62.17	100.00

126.24

62.17

Missing Years: 1963, 1969, 1970, 1971, 1972, 1973, 1974, 1975, 1976, 1977, 1978, 1979, 1980, 1981, 1982, 1983,

TALLAHASSEE MUNI AP (8758)

from 1959 to 2005 (n=45)

(minimum number of months per year at site =9)

Rainfall Event Range (in)	Number of Annual Events in Range	Mean Rainfall Depth (in)	Mean Rainfall Duration (hr)	Antecedent Dry Period (days)	Annual Event Volume	Cumulative Annual Event Volume (inches)	Cumulative Percent of Total Rainfall
0.00-0.10	49.98	0.039	0.9	64.8	1.96	1.96	3.04
0.11-0.20	14.49	0.150	1.9	65.6	2.17	4.13	6.40
0.21-0.30	9.71	0.252	2.3	65.3	2.45	6.58	10.20
0.31-0.40	6.89	0.353	3.2	72.0	2.44	9.02	13.97
0.41-0.50	6.04	0.453	3.5	70.0	2.74	11.76	18.21
0.51-1.00	17.09	0.726	4.7	71.9	12.41	24.17	37.44
1.01-1.50	8.78	1.219	6.7	64.3	10.70	34.87	54.02
1.51-2.00	4.27	1.730	7.8	77.5	7.38	42.25	65.45
2.01-2.50	2.31	2.217	10.7	75.5	5.12	47.37	73.39
2.51-3.00	1.36	2.714	14.8	71.5	3.68	51.05	79.09
3.01-3.50	1.07	3.211	17.5	71.1	3.43	54.48	84.39
3.51-4.00	0.47	3.768	11.6	75.9	1.76	56.24	87.12
4.01-4.50	0.22	4.240	16.0	68.4	0.94	57.18	88.58
4.51-5.00	0.29	4.778	26.5	55.3	1.38	58.56	90.71
5.01-5.50	0.13	5.375	18.5	73.0	0.72	59.27	91.82
5.51-6.00	0.16	5.689	25.6	87.6	0.88	60.16	93.19
6.01-6.50	0.09	6.130	36.0	58.5	0.54	60.70	94.04
6.51-7.00	0.11	6.676	26.8	127.0	0.74	61.45	95.19
7.01-7.50	0.07	7.117	35.0	32.3	0.47	61.92	95.92
7.51-8.00	0.07	7.790	28.3	58.0	0.52	62.44	96.73
8.01-8.50	0.07	8.290	22.7	148.0	0.55	62.99	97.58
8.51-9.00	0.04	8.875	45.0	20.0	0.39	63.39	98.19
>9.00	0.11	10.490	33.8	73.4	1.17	64.55	100.00

123.80

64.55

Missing Years: 1961, 1987

BRANFORD (3543)

from 1945 to 2004 (n=53)

(minimum number of months per year at site =9)

Rainfall Event Range (in)	Number of Annual Events in Range	Mean Rainfall Depth (in)	Mean Rainfall Duration (hr)	Antecedent Dry Period (days)	Annual Event Volume	Cumulative Annual Event Volume (inches)	Cumulative Percent of Total Rainfall
0.00-0.10	42.23	0.077	0.8	73.3	3.26	3.26	6.23
0.11-0.20	13.55	0.178	1.6	84.6	2.41	5.67	10.85
0.21-0.30	9.21	0.280	3.9	81.6	2.57	8.24	15.77
0.31-0.40	6.26	0.380	2.5	74.5	2.38	10.63	20.33
0.41-0.50	4.96	0.482	3.2	90.3	2.39	13.02	24.90
0.51-1.00	15.60	0.745	4.3	82.2	11.63	24.64	47.15
1.01-1.50	6.85	1.238	6.1	79.0	8.48	33.12	63.37
1.51-2.00	3.83	1.750	8.0	94.4	6.70	39.82	76.19
2.01-2.50	1.81	2.288	9.6	86.1	4.14	43.97	84.12
2.51-3.00	0.83	2.743	11.1	48.9	2.28	46.25	88.48
3.01-3.50	0.45	3.283	17.9	62.9	1.49	47.73	91.32
3.51-4.00	0.26	3.736	17.4	69.3	0.99	48.72	93.21
4.01-4.50	0.26	4.208	10.4	56.6	1.11	49.83	95.33
4.51-5.00	0.08	4.648	18.8	144.8	0.35	50.18	96.00
5.01-5.50	0.11	5.267	27.5	72.0	0.60	50.78	97.15
5.51-6.00	0.02	5.800	37.0	7.0	0.11	50.89	97.35
6.01-6.50	0.02	6.400	33.0	13.0	0.12	51.01	97.59
6.51-7.00	0.06	6.867	30.0	155.0	0.39	51.40	98.33
7.01-7.50	0.02	7.100	23.0	386.0	0.13	51.53	98.59
7.51-8.00	---	---	---	---	---	51.53	98.59
8.01-8.50	0.02	8.400	32.0	4.0	0.16	51.69	98.89
8.51-9.00	---	---	---	---	---	51.69	98.89
>9.00	0.06	10.263	30.0	116.0	0.58	52.27	100.00

106.49

52.27

Missing Years: 1947, 1950, 1951, 1973, 1998, 2001, 2002

ORLANDO INTL ARPT (6628)

from 1942 to 2005 (n=62)

(minimum number of months per year at site =9)

Rainfall Event Range (in)	Number of Annual Events in Range	Mean Rainfall Depth (in)	Mean Rainfall Duration (hr)	Antecedent Dry Period (days)	Annual Event Volume	Cumulative Annual Event Volume (inches)	Cumulative Percent of Total Rainfall
0.00-0.10	54.85	0.041	0.9	68.3	2.23	2.23	4.45
0.11-0.20	18.52	0.152	1.8	67.0	2.82	5.05	10.09
0.21-0.30	10.37	0.252	2.3	62.5	2.61	7.66	15.31
0.31-0.40	6.79	0.353	2.8	69.2	2.40	10.06	20.10
0.41-0.50	5.79	0.456	3.3	70.9	2.64	12.70	25.38
0.51-1.00	16.39	0.716	4.2	63.7	11.74	24.44	48.85
1.01-1.50	7.03	1.225	5.6	64.3	8.62	33.05	66.07
1.51-2.00	3.24	1.725	8.1	61.3	5.59	38.64	77.25
2.01-2.50	1.65	2.228	9.4	52.8	3.66	42.31	84.57
2.51-3.00	0.82	2.702	13.5	65.7	2.22	44.53	89.01
3.01-3.50	0.39	3.271	9.9	37.1	1.27	45.80	91.55
3.51-4.00	0.31	3.721	19.7	43.1	1.14	46.94	93.82
4.01-4.50	0.18	4.218	17.9	66.2	0.75	47.69	95.32
4.51-5.00	0.06	4.703	15.3	48.8	0.30	47.99	95.93
5.01-5.50	0.10	5.203	25.2	61.0	0.50	48.49	96.93
5.51-6.00	0.10	5.767	29.0	109.2	0.56	49.05	98.05
6.01-6.50	0.03	6.255	59.0	7.5	0.20	49.25	98.45
6.51-7.00	---	---	---	---	---	49.25	98.45
7.01-7.50	0.02	7.280	42.0	87.0	0.12	49.37	98.69
7.51-8.00	0.02	7.900	30.0	40.0	0.13	49.50	98.94
8.01-8.50	0.02	8.190	3.0	21.0	0.13	49.63	99.21
8.51-9.00	---	---	---	---	---	49.63	99.21
>9.00	0.03	12.310	66.0	73.0	0.40	50.03	100.00

126.69

50.03

Missing Years: 1945, 1974

MELBOURNE REGIONAL AP (5612)

from 1942 to 2005 (n=47)

(minimum number of months per year at site =9)

Rainfall Event Range (in)	Number of Annual Events in Range	Mean Rainfall Depth (in)	Mean Rainfall Duration (hr)	Antecedent Dry Period (days)	Annual Event Volume	Cumulative Annual Event Volume (inches)	Cumulative Percent of Total Rainfall
0.00-0.10	45.04	0.075	0.7	78.4	3.38	3.38	7.12
0.11-0.20	16.74	0.179	1.3	83.9	3.00	6.38	13.43
0.21-0.30	8.81	0.279	1.7	81.8	2.46	8.84	18.60
0.31-0.40	6.28	0.378	2.3	78.0	2.37	11.21	23.60
0.41-0.50	4.51	0.479	2.6	73.3	2.16	13.37	28.14
0.51-1.00	13.89	0.736	3.7	77.4	10.23	23.60	49.67
1.01-1.50	6.40	1.252	5.6	65.3	8.02	31.62	66.54
1.51-2.00	2.96	1.748	7.6	80.4	5.17	36.79	77.43
2.01-2.50	1.28	2.255	7.8	59.1	2.88	39.67	83.49
2.51-3.00	0.70	2.717	16.2	98.4	1.91	41.58	87.50
3.01-3.50	0.40	3.299	10.9	63.9	1.33	42.91	90.31
3.51-4.00	0.23	3.730	15.6	61.9	0.87	43.78	92.15
4.01-4.50	0.21	4.219	22.0	115.1	0.90	44.68	94.04
4.51-5.00	0.15	4.781	19.3	149.6	0.71	45.39	95.53
5.01-5.50	0.11	5.334	15.4	46.8	0.57	45.96	96.73
5.51-6.00	0.04	5.650	36.0	14.5	0.24	46.20	97.23
6.01-6.50	---	---	---	---	---	46.20	97.23
6.51-7.00	0.02	6.560	26.0	12.0	0.14	46.34	97.53
7.01-7.50	0.09	7.260	25.8	44.8	0.62	46.96	98.83
7.51-8.00	---	---	---	---	---	46.96	98.83
8.01-8.50	0.04	8.140	39.0	29.5	0.35	47.31	99.56
8.51-9.00	---	---	---	---	---	47.31	99.56
>9.00	0.02	9.890	73.0	12.0	0.21	47.52	100.00

107.94

47.52

Missing Years: 1954, 1955, 1957, 1958, 1960, 1966, 1967, 1986, 1987, 1995, 1996, 1997, 1998, 1999, 2000, 2003,

KEY WEST WB CITY (4575)

from 1942 to 2005 (n=63)

(minimum number of months per year at site =9)

Rainfall Event Range (in)	Number of Annual Events in Range	Mean Rainfall Depth (in)	Mean Rainfall Duration (hr)	Antecedent Dry Period (days)	Annual Event Volume	Cumulative Annual Event Volume (inches)	Cumulative Percent of Total Rainfall
0.00-0.10	68.56	0.037	0.8	66.6	2.52	2.52	6.45
0.11-0.20	17.40	0.149	1.5	71.2	2.59	5.11	13.09
0.21-0.30	9.70	0.250	2.0	65.6	2.43	7.54	19.30
0.31-0.40	6.60	0.353	2.4	69.5	2.33	9.87	25.26
0.41-0.50	4.51	0.453	3.1	62.1	2.04	11.91	30.49
0.51-1.00	11.97	0.712	4.1	67.0	8.52	20.44	52.30
1.01-1.50	4.11	1.236	6.2	68.2	5.08	25.52	65.31
1.51-2.00	2.05	1.730	7.9	59.4	3.54	29.06	74.37
2.01-2.50	0.86	2.225	9.6	78.0	1.91	30.96	79.25
2.51-3.00	0.56	2.752	12.8	85.4	1.53	32.49	83.17
3.01-3.50	0.41	3.255	12.0	78.5	1.34	33.84	86.60
3.51-4.00	0.17	3.795	20.2	65.9	0.66	34.50	88.30
4.01-4.50	0.19	4.161	18.5	89.3	0.79	35.29	90.33
4.51-5.00	0.06	4.728	16.0	35.5	0.30	35.59	91.10
5.01-5.50	0.05	5.170	16.7	72.3	0.25	35.84	91.73
5.51-6.00	0.05	5.783	32.7	111.3	0.28	36.11	92.43
6.01-6.50	0.05	6.227	45.0	30.7	0.30	36.41	93.19
6.51-7.00	0.06	6.728	32.0	33.8	0.43	36.84	94.28
7.01-7.50	0.03	7.105	41.0	33.5	0.23	37.06	94.86
7.51-8.00	0.03	7.735	29.0	93.5	0.25	37.31	95.49
8.01-8.50	---	---	---	---	---	37.31	95.49
8.51-9.00	0.05	8.653	32.7	26.7	0.41	37.72	96.54
>9.00	0.10	14.183	35.5	12.5	1.35	39.07	100.00
	127.56					39.07	

Missing Years: 1952

FORT MYERS PAGE FLD (3186)

from 1960 to 2003 (n=28)

(minimum number of months per year at site =9)

Rainfall Event Range (in)	Number of Annual Events in Range	Mean Rainfall Depth (in)	Mean Rainfall Duration (hr)	Antecedent Dry Period (days)	Annual Event Volume	Cumulative Annual Event Volume (inches)	Cumulative Percent of Total Rainfall
0.00-0.10	42.71	0.069	0.7	82.1	2.93	2.93	5.51
0.11-0.20	15.39	0.170	1.1	81.8	2.61	5.54	10.43
0.21-0.30	10.50	0.273	1.7	94.9	2.87	8.41	15.83
0.31-0.40	5.54	0.380	1.9	74.3	2.10	10.51	19.78
0.41-0.50	5.00	0.479	2.5	78.2	2.39	12.91	24.29
0.51-1.00	15.00	0.746	3.0	63.7	11.19	24.10	45.35
1.01-1.50	6.93	1.259	3.8	59.2	8.72	32.82	61.77
1.51-2.00	3.64	1.766	4.9	70.8	6.43	39.25	73.87
2.01-2.50	1.82	2.284	6.8	96.8	4.16	43.41	81.70
2.51-3.00	0.89	2.757	4.8	62.1	2.46	45.87	86.34
3.01-3.50	0.50	3.221	9.1	37.1	1.61	47.48	89.37
3.51-4.00	0.21	3.690	3.8	45.7	0.79	48.28	90.86
4.01-4.50	0.14	4.128	19.0	77.7	0.59	48.87	91.97
4.51-5.00	0.21	4.700	17.7	48.2	1.01	49.87	93.86
5.01-5.50	0.07	5.410	13.0	14.0	0.39	50.26	94.59
5.51-6.00	0.14	5.715	26.3	33.8	0.82	51.08	96.12
6.01-6.50	0.04	6.180	37.0	24.0	0.22	51.30	96.54
6.51-7.00	---	---	---	---	---	51.30	96.54
7.01-7.50	---	---	---	---	---	51.30	96.54
7.51-8.00	0.07	7.800	14.0	238.0	0.56	51.85	97.59
8.01-8.50	0.04	8.200	7.0	78.0	0.29	52.15	98.14
8.51-9.00	0.07	8.765	44.0	44.5	0.63	52.77	99.32
>9.00	0.04	10.150	34.0	14.0	0.36	53.13	100.00

108.96

53.13

Missing Years: 1967, 1980, 1982, 1983, 1984, 1986, 1987, 1990, 1991, 1992, 1996, 1997, 1998, 1999, 2000, 2001

CROSS CITY (2006)

from 1942 to 2000 (n=47)

(minimum number of months per year at site =9)

Rainfall Event Range (in)	Number of Annual Events in Range	Mean Rainfall Depth (in)	Mean Rainfall Duration (hr)	Antecedent Dry Period (days)	Annual Event Volume	Cumulative Annual Event Volume (inches)	Cumulative Percent of Total Rainfall
0.00-0.10	38.66	0.075	0.8	72.8	2.91	2.91	5.27
0.11-0.20	14.11	0.176	1.6	87.1	2.49	5.40	9.79
0.21-0.30	9.77	0.277	2.0	81.0	2.71	8.10	14.69
0.31-0.40	6.91	0.376	2.5	75.2	2.60	10.70	19.40
0.41-0.50	5.17	0.480	3.0	89.5	2.48	13.18	23.91
0.51-1.00	15.32	0.737	4.0	83.2	11.29	24.48	44.39
1.01-1.50	7.26	1.247	5.7	91.3	9.05	33.52	60.79
1.51-2.00	3.51	1.742	7.5	86.0	6.12	39.64	71.89
2.01-2.50	2.04	2.247	10.1	77.7	4.59	44.23	80.21
2.51-3.00	1.17	2.757	12.7	77.6	3.23	47.45	86.06
3.01-3.50	0.68	3.259	13.0	58.0	2.22	49.67	90.08
3.51-4.00	0.32	3.769	14.2	103.9	1.20	50.88	92.26
4.01-4.50	0.17	4.226	23.1	59.7	0.72	51.60	93.57
4.51-5.00	0.11	4.854	11.4	108.0	0.52	52.11	94.51
5.01-5.50	0.13	5.335	29.0	29.8	0.68	52.79	95.74
5.51-6.00	0.06	5.650	25.7	84.7	0.36	53.15	96.39
6.01-6.50	0.04	6.250	21.5	99.0	0.27	53.42	96.88
6.51-7.00	0.06	6.667	30.3	72.3	0.43	53.85	97.65
7.01-7.50	0.04	7.250	20.0	14.0	0.31	54.15	98.21
7.51-8.00	---	---	---	---	---	54.15	98.21
8.01-8.50	0.02	8.150	49.0	9.0	0.17	54.33	98.52
8.51-9.00	0.04	8.825	30.0	202.5	0.38	54.70	99.20
>9.00	0.04	10.320	28.5	31.5	0.44	55.14	100.00

105.64

55.14

Missing Years: 1959, 1963, 1964, 1965, 1971, 1972, 1975, 1976, 1977, 1981, 1995, 1998

TAMPA INTL ARPT (8788)

from 1949 to 2005 (n=47)

(minimum number of months per year at site =9)

Rainfall Event Range (in)	Number of Annual Events in Range	Mean Rainfall Depth (in)	Mean Rainfall Duration (hr)	Antecedent Dry Period (days)	Annual Event Volume	Cumulative Annual Event Volume (inches)	Cumulative Percent of Total Rainfall
0.00-0.10	48.45	0.038	0.9	76.1	1.86	1.86	4.05
0.11-0.20	14.77	0.150	1.7	75.3	2.22	4.08	8.86
0.21-0.30	9.57	0.253	2.2	79.6	2.43	6.51	14.13
0.31-0.40	6.38	0.352	3.2	82.7	2.24	8.75	19.00
0.41-0.50	5.34	0.455	3.4	85.4	2.43	11.18	24.27
0.51-1.00	14.13	0.725	4.2	75.5	10.24	21.43	46.51
1.01-1.50	6.36	1.230	5.5	68.1	7.82	29.25	63.49
1.51-2.00	3.02	1.705	8.6	69.4	5.15	34.40	74.67
2.01-2.50	1.64	2.253	9.9	69.1	3.69	38.09	82.68
2.51-3.00	0.66	2.767	15.8	52.5	1.83	39.92	86.64
3.01-3.50	0.60	3.239	15.9	35.6	1.93	41.85	90.83
3.51-4.00	0.34	3.758	17.4	104.3	1.28	43.13	93.61
4.01-4.50	0.23	4.311	23.0	36.5	1.01	44.13	95.80
4.51-5.00	0.06	4.650	25.3	6.3	0.30	44.43	96.44
5.01-5.50	0.09	5.185	34.0	35.0	0.44	44.87	97.40
5.51-6.00	0.02	5.700	34.0	20.0	0.12	44.99	97.67
6.01-6.50	---	---	---	---	---	44.99	97.67
6.51-7.00	---	---	---	---	---	44.99	97.67
7.01-7.50	0.02	7.370	69.0	7.0	0.16	45.15	98.01
7.51-8.00	0.02	7.550	70.0	5.0	0.16	45.31	98.35
8.01-8.50	---	---	---	---	---	45.31	98.35
8.51-9.00	---	---	---	---	---	45.31	98.35
>9.00	0.06	11.873	32.7	18.0	0.76	46.07	100.00

111.77

46.07

Missing Years: 1952, 1953, 1954, 1955, 1956, 1957, 1958, 1967, 2001, 2002

JACKSONVILLE (4371)

from 1942 to 2005 (n=64)

(minimum number of months per year at site =9)

Rainfall Event Range (in)	Number of Annual Events in Range	Mean Rainfall Depth (in)	Mean Rainfall Duration (hr)	Antecedent Dry Period (days)	Annual Event Volume	Cumulative Annual Event Volume (inches)	Cumulative Percent of Total Rainfall
0.00-0.10	55.75	0.037	1.0	64.2	2.09	2.09	3.95
0.11-0.20	17.23	0.150	2.1	69.1	2.59	4.68	8.84
0.21-0.30	11.08	0.251	2.5	64.0	2.78	7.47	14.10
0.31-0.40	7.36	0.355	3.4	72.3	2.61	10.07	19.02
0.41-0.50	5.36	0.456	4.4	64.8	2.44	12.52	23.64
0.51-1.00	15.92	0.708	5.5	67.7	11.27	23.79	44.92
1.01-1.50	6.77	1.214	8.6	67.3	8.22	32.01	60.44
1.51-2.00	3.36	1.740	10.3	60.0	5.84	37.85	71.48
2.01-2.50	1.75	2.249	13.1	56.4	3.94	41.79	78.91
2.51-3.00	1.09	2.736	14.8	61.1	2.99	44.78	84.56
3.01-3.50	0.34	3.245	13.5	47.6	1.12	45.90	86.67
3.51-4.00	0.33	3.753	15.0	44.8	1.23	47.13	88.99
4.01-4.50	0.25	4.226	21.3	57.4	1.06	48.18	90.99
4.51-5.00	0.27	4.739	21.4	28.6	1.26	49.44	93.36
5.01-5.50	0.06	5.380	21.5	63.8	0.34	49.78	94.00
5.51-6.00	0.06	5.885	42.3	9.0	0.37	50.15	94.69
6.01-6.50	0.06	6.268	24.8	31.0	0.39	50.54	95.43
6.51-7.00	0.05	6.723	48.7	21.3	0.32	50.85	96.03
7.01-7.50	0.02	7.270	36.0	20.0	0.11	50.97	96.24
7.51-8.00	0.02	7.720	33.0	136.0	0.12	51.09	96.47
8.01-8.50	0.05	8.237	33.3	47.7	0.39	51.47	97.20
8.51-9.00	0.03	8.875	55.5	5.5	0.28	51.75	97.72
>9.00	0.11	11.023	49.6	86.6	1.21	52.96	100.00

127.31

52.96

Missing Years:

MIAMI WSO CITY (5668)

from 1942 to 2005 (n=64)

(minimum number of months per year at site =9)

Rainfall Event Range (in)	Number of Annual Events in Range	Mean Rainfall Depth (in)	Mean Rainfall Duration (hr)	Antecedent Dry Period (days)	Annual Event Volume	Cumulative Annual Event Volume (inches)	Cumulative Percent of Total Rainfall
0.00-0.10	79.33	0.038	0.8	55.2	3.02	3.02	5.31
0.11-0.20	21.64	0.150	1.7	51.9	3.24	6.26	11.00
0.21-0.30	12.53	0.251	2.1	53.4	3.15	9.41	16.53
0.31-0.40	7.84	0.352	2.5	46.8	2.76	12.17	21.38
0.41-0.50	6.02	0.455	3.0	59.7	2.73	14.90	26.18
0.51-1.00	15.70	0.714	4.2	49.5	11.20	26.11	45.87
1.01-1.50	6.59	1.225	5.9	42.5	8.08	34.18	60.06
1.51-2.00	3.42	1.748	8.9	49.0	5.98	40.17	70.57
2.01-2.50	1.88	2.224	11.2	65.6	4.17	44.34	77.89
2.51-3.00	1.30	2.741	10.6	42.6	3.56	47.89	84.14
3.01-3.50	0.55	3.226	19.0	40.1	1.76	49.66	87.24
3.51-4.00	0.36	3.752	17.0	26.3	1.35	51.00	89.61
4.01-4.50	0.31	4.233	14.3	40.6	1.32	52.33	91.93
4.51-5.00	0.09	4.787	14.5	52.3	0.45	52.78	92.72
5.01-5.50	0.14	5.227	23.3	25.4	0.74	53.51	94.01
5.51-6.00	0.08	5.804	17.2	102.4	0.45	53.96	94.81
6.01-6.50	0.11	6.184	25.4	14.9	0.68	54.64	95.99
6.51-7.00	0.05	6.853	24.3	6.3	0.32	54.96	96.56
7.01-7.50	0.03	7.235	27.5	10.0	0.23	55.19	96.96
7.51-8.00	0.03	7.805	44.5	8.5	0.24	55.43	97.39
8.01-8.50	0.03	8.180	27.5	83.0	0.26	55.69	97.83
8.51-9.00	0.02	8.590	22.0	8.0	0.13	55.82	98.07
>9.00	0.09	11.718	35.7	60.3	1.10	56.92	100.00

158.14

56.92

Missing Years: #VALUE!

APPENDIX B

**HYDROLOGIC CHARACTERISTICS
FROM SELECTED STORMWATER LAND USE
CHARACTERIZATION STUDIES**

TABLE B.1

**SUMMARY OF HYDROLOGIC CHARACTERISTICS
FROM SINGLE-FAMILY RESIDENTIAL STORMWATER
STUDIES IN FLORIDA**

LOCATION	PARAMETER				REFERENCE
	WATERSHED AREA (acres)	PERCENT IMPERVIOUS (%)	LAND USE	DRAINAGE SYSTEM	
Pompano Beach	40.8	43.9	Single-family residential (5.3 units/acre)	Grass swales	Matraw, et al. (1981)
Tampa - Charter Street	42.0	14.0	Single-family residential (2 units/acre)	12% curb-gutter, 75% grass swales, 13% ditches (100% sewer)	U.S. EPA (1983)
Maitland (3 basins)	Not provided	Not provided	Single-family residential (3 watersheds)	Curb and gutter; grassed swales	German (1983)
Tampa - Kirby Street	897	19.0	68% single-family (2.5 units/acre)	Curb and gutter	Lopez, et al. (1984)
Tampa - St. Louis Street Ditch	326	27.0	69% single-family (2 units/acre)	Curb and gutter	Lopez, et al. (1984)
Orlando Duplex	25.13	34.0	Duplex (4 units/acre)	Curb and gutter	Harper (1988)
Orlando - Essex Pointe	7.39	65.0	Cluster homes	100% curb and gutter	Harper (1988)
Springhill Subdivision, Palm Beach	32.4	37.0	Single-family residential (3 units/acre)	Grass swales	Greg, et al. (1989)
Tampa - 102 nd Avenue	70.0	N/A	Single-family residential	Curb and gutter	Holtkamp (1998)
Bradfordville, FL	16.8	35.0	Single-family residential	Curb and gutter	ERD (2000)
Key Colony, Florida Keys	24.3	6.1	Single-family residential with golf course	Overland flow to grassed swales	ERD (2002)
Tallahassee - Woodgate Subdivision	214		Single-family residential	Curb and gutter	COT and ERD (2002)
Sarasota County	30.0	25.0	Single-family residential	Grass swales	ERD (2004)
Orlando - Krueger St.	52.9	37.0	Single-family residential	Curb and gutter; stormsewers	ERD (2004)
Orlando - Paseo Street	19.4	53.0	Single-family residential	Curb and gutter; roadside swales	ERD (2004)
Windermere	95.42	29.4	Single-family residential	Grass swales	ERD (2007)
Overall Mean Value	--	33.0	--	--	--

TABLE B.2**SUMMARY OF HYDROLOGIC CHARACTERISTICS
FROM MULTI-FAMILY RESIDENTIAL STORMWATER
STUDIES IN FLORIDA**

LOCATION	PARAMETER				REFERENCE
	WATERSHED AREA (acres)	PERCENT IMPERVIOUS (%)	LAND USE	DRAINAGE SYSTEM	
Orlando - Shoals Apartments	N/A	74.0	Apartments	100% grates and sewers	ECFRPC (1978)
Miami - Kings Creek Apartments	14.7	70.7	Apartments	Drainage along centerline of roadway	Miller (1979)
Loch Lomond	26.0	65.0	High-density (18 units/acre)	100% grates and sewers	Weinburg, et al. (1980)
Orlando - Downtown	62.5	66.4	High-density	100% curb and gutter	Wanielista, et al. (1982)
Tampa - Young Apartments	8.7	61.0	High-density multi-family	100% curb and gutter	U.S. EPA (1983)
Tallahassee - Royal Pavilion Apartments	73.3	65.0	Apartments	100% curb and gutter	COT and ERD (2002)
Overall Mean Value	--	67.0	--	--	--

TABLE B.3

**SUMMARY OF HYDROLOGIC CHARACTERISTICS
FROM LOW-INTENSITY COMMERCIAL STORMWATER
STUDIES IN FLORIDA**

LOCATION	PARAMETER				REFERENCE
	WATERSHED AREA (acres)	PERCENT IMPERVIOUS (%)	LAND USE	DRAINAGE SYSTEM	
Orlando Areawide Study ¹	--	75.5	Parking lot, motel, strip commercial	Curb and gutter or inlets with sewers	ECFRPC (1978)
Ft. Lauderdale - Coral Ridge Mall	20.4	98.0	Shopping center	100% inlets and stormsewers	Miller (1979)
Tampa - Norma Park	46.6	90.3	Commercial	21.7% curb/gutter, 72.5% ditch/swale 5.8% grass swale	U.S. EPA (1983)
Orlando - International Market Place	2.17	100	Parking lot, strip mall	100% inlets and stormsewers	Harper (1988)
DeBary	50.7	59.6	Commercial areas along U.S. 17	41% stormsewer, 59% roadside swale	Harper and Herr (1993)
Bradfordville	8.0	90	Parking lot, rooftop landscaping	100% inlets and stormsewers	ERD (2000)
Tallahassee - Cross Creek Shopping Center	46.0		Mixed commercial, office, and public areas	100% inlets and stormsewers	COT and ERD (2002)
Sarasota County	N/A	N/A	Commercial area along major highway	100% inlets and stormsewers	ERD (2004)
Florida Aquarium - Tampa	11.25	90	Parking lot (700,000 visitors annually)	Swales to inlet drop boxes	Teague, et al. (2005)
Overall Mean Value	--	91.0	--	--	--

1. Average of studies performed on a parking lot, motel complex, and commercial strip development

TABLE B.4

**SUMMARY OF HYDROLOGIC CHARACTERISTICS
FROM HIGH-INTENSITY COMMERCIAL STORMWATER
STUDIES IN FLORIDA**

LOCATION	PARAMETER				REFERENCE
	WATERSHED AREA (acres)	PERCENT IMPERVIOUS (%)	LAND USE	DRAINAGE SYSTEM	
Broward County	28.4	98.0	Regional shopping mall	Overland flow to collection system	Matraw, et al. (1981)
Orlando - Downtown Area	83.3	96.4	Downtown commercial/office area, parking lots	100% curb and gutter	Wanielista (1982)
Dade County	N/A	98.0	Commercial area with heavy traffic	Overland flow to roadside swale	Waller (1984)
Broward County	N/A	98.0	Heavily traveled highway with adjacent commercial area	Overland flow to roadside swale	Howie, et al. (1986)
Overall Mean Value	--	97.5	--	--	--

TABLE B.5

**SUMMARY OF HYDROLOGIC CHARACTERISTICS FROM
LIGHT INDUSTRIAL STORMWATER STUDIES IN FLORIDA**

LOCATION	PARAMETER			REFERENCE
	WATERSHED AREA (acres)	PERCENT IMPERVIOUS (%)	LAND USE	
Orlando Areawide Study	N/A	N/A	Light industrial park	ECFRPC (1985)
Manatee County Southeast Area Study	N/A	70	Light industrial	CDM (1985)
Tallahassee	N/A	N/A	Light industrial park	COT and ERD (2002)
Winter Haven	43.9	62	Light industrial and warehouse	ERD (2007)
Overall Mean Value	--	66	--	--

TABLE B.6

**SUMMARY OF HYDROLOGIC CHARACTERISTICS
FROM HIGHWAY / TRANSPORTATION STORMWATER
STUDIES IN FLORIDA**

LOCATION	PARAMETER				REFERENCE
	WATERSHED AREA (acres)	PERCENT IMPERVIOUS (%)	LAND USE	DRAINAGE SYSTEM	
Broward County	58.3	36.4	6-lane divided highway plus roadside areas	Curb and gutter	Mattraw, et al. (1981)
I-95 Miami (Bridge)	1.43	100	Asphalt interstate highway, 70,000 vpd	Curb and gutter; inlets with sewers	McKenzie, et al. (1983)
Maitland Blvd.	48.9	--	Asphalt highway, 15,000 vpd	Curb and gutter; inlets with sewers	Yousef, et al. (1986)
I-4 EPCOT Interchange	--	--	Asphalt highway	Curb and gutter; roadside swale	Yousef, et al. (1986)
Winter Park I-4	1.17	100	Concrete interstate highway, 65,000 vpd	Curb and gutter; inlets with sewers	Harper (1988)
Orlando I-4	1.30	70	Concrete interstate highway, 69,000 vpd	Concrete swales; stormsewers	Harper (1988)
I-4 Maitland Interchange	4.0	100	Asphalt highway	Curb and gutter; inlets with sewers	Harper (1985)
Maitland	--	--	4-lane divided connector highway	Curb and gutter; inlets with sewers	German (1983)
Bayside Bridge - Tampa	12.9	100	4-lane bridge, concrete surface	Bridge drains connected to stormsewer	Stoker (1996)
Tallahassee	1.0	90	6-lane divided asphalt highway	Curb and gutter; inlets with sewers	ERD (2000)
Orlando U.S. 441	12.0	74	6-lane asphalt highway	Curb and gutter; inlets with sewers	ERD (2005) - unpublished data
Overall Mean Value	--	76.6	--	--	--

TABLE B.7

**SUMMARY OF HYDROLOGIC CHARACTERISTICS
FROM PASTURE LAND USE STORMWATER
STUDIES IN FLORIDA**

LOCATION	PARAMETER			REFERENCE
	WATERSHED AREA (acres)	SOIL TYPES	LAND USE	
St. Cloud	21.6	Poorly drained, HSG D	Pasture, cattle (1.4 acres/cow)	CH2M Hill (1977)
St. Johns River Basin	155,741	Muck, fine sand, peat	Pasture	Fall (1987)
Ash Slough	220	Felda, Myakka, Pompano sands	Pasture	Hendrickson (1987)

TABLE B.8

**SUMMARY OF HYDROLOGIC CHARACTERISTICS
FROM CITRUS LAND USE STORMWATER
STUDIES IN FLORIDA**

LOCATION	PARAMETER			REFERENCE
	WATERSHED AREA (acres)	SOIL TYPES	LAND USE	
Upper St. Johns River Basin	56,867	Muck, peat	Citrus; some row crops	Fall (1987)
St. Johns Water Control District	27,721	Organic muck, poorly drained	Citrus; some pasture	Fall, et al. (1987)
Armstrong Slough	10,000	Placid, Basinger Sands; Samsula Muck	Citrus; some pasture	Hendrickson (1987)
Upper St. Johns River Basin	27,721	Poorly drained sand	Citrus; some pasture	Fall (1990)
Gator Slough (Hendry/Collier Counties)	1,492	Sand/muck, poorly drained	Citrus	Sawka and Black (1993)
Upper St. Johns River Basin	--	Poorly drained sand	Citrus	Fall (1995)
Charlotte/DeSoto Counties (4 sites)	184-602	Poorly drained sand	Citrus	Bahk, et al. (1997)

TABLE B.9**SUMMARY OF HYDROLOGIC CHARACTERISTICS
FROM ROW CROP STORMWATER STUDIES IN FLORIDA**

LOCATION	PARAMETER			REFERENCE
	WATERSHED AREA (acres)	SOIL TYPES	LAND USE	
Willowbrook Farms	5680	Felda, Wabasso Sands; Canova Peat	Row crop	Hendrickson (1987)
Upper St. Johns River Basin	N/A	Sand/muck	Row crops; some citrus	Fall (1987)
Upper St. Johns River Basin	N/A	Sand/muck	Row crops; some pasture	Fall (1990)
Upper St. Johns River Basin	N/A	Sand/muck	Row crops; some dairy	Fall (1995)
Manatee County (5 sites)	5 areas ranging from 12-20 acres	Sand/muck	Row crops; tomatoes	Bahk, et al. (1997)
Cockroach Bay (Ruskin, FL)	210	Sand/muck	Row crops	Bahk (1997)
Upper St. Johns River Basin (3 sites)	N/A	Sand/muck	Row crops	Hendrickson (unpublished data)
Cockroach Bay (Ruskin, FL)	210	Sand/muck	Row crops	Rushton (2002)

TABLE B.10**SUMMARY OF HYDROLOGIC CHARACTERISTICS
FROM UNDEVELOPED / RANGELAND / FOREST
STORMWATER STUDIES IN FLORIDA**

LOCATION	PARAMETER			REFERENCE
	WATERSHED AREA (acres)	PERCENT IMPERVIOUS (%)	LAND USE	
Orlando ECFRPC	N/A	0	Flatwood	CH2M Hill (1977)
Miami	N/A	0	Range/park	Waller (1982)
Boggy Creek Study	N/A	2	Range/park	ECFRPC (1988)
Tallahassee - Tom Brown Park	N/A	0	Park/open	COT and ERD (2002)
Sarasota/Charlotte Counties (3 sites)	N/A	0	Range/forest	ERD (2004)
Overall Mean Value	--	1.5	--	--

TABLE B.11

**SUMMARY OF HYDROLOGIC CHARACTERISTICS
FROM MINING / EXTRACTIVE STORMWATER
STUDIES IN FLORIDA**

LOCATION	PARAMETER			REFERENCE
	WATERSHED AREA (acres)	PERCENT IMPERVIOUS (%)	LAND USE	
Boggy Creek Study	N/A	23	Mixed mining activities	ECFRPC (1988)
Overall Mean Value	--	23	--	--

APPENDIX C

**CALCULATED ANNUAL RUNOFF
COEFFICIENTS FOR THE DESIGNATED
METEOROLOGICAL ZONES AS A FUNCTION
OF CURVE NUMBER AND DCIA**

Zone 1

Mean Annual Runoff Coefficients (C Values) as a Function of DCIA Percentage and Non-DCIA Curve Number (CN)

NDCIA CN	Percent DCIA																				
	0	5	10	15	20	25	30	35	40	45	50	55	60	65	70	75	80	85	90	95	100
30	0.006	0.048	0.090	0.132	0.175	0.217	0.259	0.301	0.343	0.386	0.428	0.470	0.512	0.554	0.596	0.639	0.681	0.723	0.765	0.807	0.849
35	0.009	0.051	0.093	0.135	0.177	0.219	0.261	0.303	0.345	0.387	0.429	0.471	0.513	0.555	0.597	0.639	0.681	0.723	0.765	0.807	0.849
40	0.014	0.056	0.098	0.139	0.181	0.223	0.265	0.307	0.348	0.390	0.432	0.474	0.515	0.557	0.599	0.641	0.682	0.724	0.766	0.808	0.849
45	0.020	0.062	0.103	0.145	0.186	0.228	0.269	0.311	0.352	0.394	0.435	0.476	0.518	0.559	0.601	0.642	0.684	0.725	0.767	0.808	0.849
50	0.029	0.070	0.111	0.152	0.193	0.234	0.275	0.316	0.357	0.398	0.439	0.480	0.521	0.562	0.603	0.644	0.685	0.726	0.767	0.808	0.849
55	0.039	0.079	0.120	0.161	0.201	0.242	0.282	0.323	0.363	0.404	0.444	0.485	0.525	0.566	0.606	0.647	0.687	0.728	0.768	0.809	0.849
60	0.052	0.092	0.132	0.172	0.212	0.252	0.291	0.331	0.371	0.411	0.451	0.491	0.531	0.570	0.610	0.650	0.690	0.730	0.770	0.810	0.849
65	0.069	0.108	0.147	0.186	0.225	0.264	0.303	0.342	0.381	0.420	0.459	0.498	0.537	0.576	0.615	0.654	0.693	0.732	0.771	0.810	0.849
70	0.092	0.130	0.167	0.205	0.243	0.281	0.319	0.357	0.395	0.433	0.471	0.508	0.546	0.584	0.622	0.660	0.698	0.736	0.774	0.812	0.849
75	0.121	0.158	0.194	0.230	0.267	0.303	0.340	0.376	0.412	0.449	0.485	0.522	0.558	0.595	0.631	0.667	0.704	0.740	0.777	0.813	0.849
80	0.162	0.196	0.230	0.265	0.299	0.334	0.368	0.402	0.437	0.471	0.506	0.540	0.574	0.609	0.643	0.678	0.712	0.746	0.781	0.815	0.849
85	0.220	0.252	0.283	0.315	0.346	0.378	0.409	0.441	0.472	0.503	0.535	0.566	0.598	0.629	0.661	0.692	0.724	0.755	0.787	0.818	0.849
90	0.312	0.339	0.366	0.393	0.419	0.446	0.473	0.500	0.527	0.554	0.581	0.608	0.634	0.661	0.688	0.715	0.742	0.769	0.796	0.823	0.849
95	0.478	0.496	0.515	0.533	0.552	0.571	0.589	0.608	0.626	0.645	0.664	0.682	0.701	0.719	0.738	0.757	0.775	0.794	0.812	0.831	0.849
98	0.656	0.666	0.676	0.685	0.695	0.705	0.714	0.724	0.734	0.743	0.753	0.763	0.772	0.782	0.792	0.801	0.811	0.821	0.830	0.840	0.849

Zone 2

Mean Annual Runoff Coefficients (C Values) as a Function of DCIA Percentage and Non-DCIA Curve Number (CN)

NDCIA CN	Percent DCIA																					
	0	5	10	15	20	25	30	35	40	45	50	55	60	65	70	75	80	85	90	95	100	
30	0.002	0.043	0.083	0.123	0.164	0.204	0.244	0.285	0.325	0.366	0.406	0.446	0.487	0.527	0.567	0.608	0.648	0.688	0.729	0.769	0.809	0.809
35	0.004	0.044	0.085	0.125	0.165	0.205	0.246	0.286	0.326	0.366	0.407	0.447	0.487	0.528	0.568	0.608	0.648	0.689	0.729	0.769	0.809	0.809
40	0.007	0.047	0.087	0.127	0.167	0.207	0.248	0.288	0.328	0.368	0.408	0.448	0.488	0.528	0.569	0.609	0.649	0.689	0.729	0.769	0.809	0.809
45	0.010	0.050	0.090	0.130	0.170	0.210	0.250	0.290	0.330	0.370	0.410	0.450	0.490	0.530	0.570	0.610	0.650	0.690	0.729	0.769	0.809	0.809
50	0.015	0.055	0.095	0.134	0.174	0.214	0.254	0.293	0.333	0.373	0.412	0.452	0.492	0.531	0.571	0.611	0.651	0.690	0.730	0.770	0.809	0.809
55	0.022	0.061	0.101	0.140	0.179	0.219	0.258	0.298	0.337	0.376	0.416	0.455	0.494	0.534	0.573	0.613	0.652	0.691	0.731	0.770	0.809	0.809
60	0.030	0.069	0.108	0.147	0.186	0.225	0.264	0.303	0.342	0.381	0.420	0.459	0.498	0.537	0.576	0.615	0.654	0.693	0.731	0.770	0.809	0.809
65	0.042	0.080	0.119	0.157	0.195	0.234	0.272	0.311	0.349	0.387	0.426	0.464	0.502	0.541	0.579	0.618	0.656	0.694	0.733	0.771	0.809	0.809
70	0.057	0.095	0.133	0.170	0.208	0.245	0.283	0.321	0.358	0.396	0.433	0.471	0.509	0.546	0.584	0.621	0.659	0.697	0.734	0.772	0.809	0.809
75	0.079	0.116	0.152	0.189	0.225	0.262	0.298	0.335	0.371	0.408	0.444	0.481	0.517	0.554	0.590	0.627	0.663	0.700	0.736	0.773	0.809	0.809
80	0.111	0.146	0.181	0.216	0.251	0.285	0.320	0.355	0.390	0.425	0.460	0.495	0.530	0.565	0.600	0.635	0.670	0.705	0.740	0.774	0.809	0.809
85	0.160	0.192	0.225	0.257	0.290	0.322	0.355	0.387	0.420	0.452	0.485	0.517	0.550	0.582	0.614	0.647	0.679	0.712	0.744	0.777	0.809	0.809
90	0.242	0.270	0.299	0.327	0.355	0.384	0.412	0.440	0.469	0.497	0.526	0.554	0.582	0.611	0.639	0.667	0.696	0.724	0.753	0.781	0.809	0.809
95	0.404	0.424	0.444	0.464	0.485	0.505	0.525	0.546	0.566	0.586	0.606	0.627	0.647	0.667	0.688	0.708	0.728	0.749	0.769	0.789	0.809	0.809
98	0.595	0.605	0.616	0.627	0.638	0.648	0.659	0.670	0.680	0.691	0.702	0.713	0.723	0.734	0.745	0.756	0.766	0.777	0.788	0.799	0.809	0.809

Zone 3

Mean Annual Runoff Coefficients (C Values) as a Function of DCIA Percentage and Non-DCIA Curve Number (CN)

NDCIA CN	Percent DCIA																					
	0	5	10	15	20	25	30	35	40	45	50	55	60	65	70	75	80	85	90	95	100	
30	0.008	0.047	0.087	0.126	0.165	0.205	0.244	0.283	0.323	0.362	0.401	0.441	0.480	0.519	0.559	0.598	0.637	0.677	0.716	0.756	0.795	0.795
35	0.012	0.051	0.090	0.129	0.168	0.207	0.247	0.286	0.325	0.364	0.403	0.442	0.482	0.521	0.560	0.599	0.638	0.677	0.717	0.756	0.795	0.795
40	0.016	0.055	0.094	0.133	0.172	0.211	0.250	0.289	0.328	0.367	0.406	0.445	0.483	0.522	0.561	0.600	0.639	0.678	0.717	0.756	0.795	0.795
45	0.022	0.061	0.099	0.138	0.177	0.215	0.254	0.292	0.331	0.370	0.408	0.447	0.486	0.524	0.563	0.602	0.640	0.679	0.718	0.756	0.795	0.795
50	0.029	0.067	0.105	0.144	0.182	0.220	0.259	0.297	0.335	0.374	0.412	0.450	0.488	0.527	0.565	0.603	0.642	0.680	0.718	0.757	0.795	0.795
55	0.037	0.075	0.113	0.151	0.189	0.227	0.265	0.302	0.340	0.378	0.416	0.454	0.492	0.530	0.568	0.605	0.643	0.681	0.719	0.757	0.795	0.795
60	0.048	0.085	0.123	0.160	0.197	0.235	0.272	0.309	0.347	0.384	0.421	0.459	0.496	0.533	0.571	0.608	0.645	0.683	0.720	0.758	0.795	0.795
65	0.061	0.098	0.134	0.171	0.208	0.244	0.281	0.318	0.355	0.391	0.428	0.465	0.501	0.538	0.575	0.611	0.648	0.685	0.721	0.758	0.795	0.795
70	0.078	0.114	0.149	0.185	0.221	0.257	0.293	0.329	0.365	0.400	0.436	0.472	0.508	0.544	0.580	0.616	0.651	0.687	0.723	0.759	0.795	0.795
75	0.100	0.135	0.170	0.204	0.239	0.274	0.308	0.343	0.378	0.413	0.447	0.482	0.517	0.552	0.586	0.621	0.656	0.691	0.725	0.760	0.795	0.795
80	0.131	0.164	0.197	0.231	0.264	0.297	0.330	0.363	0.397	0.430	0.463	0.496	0.529	0.562	0.596	0.629	0.662	0.695	0.728	0.762	0.795	0.795
85	0.177	0.208	0.239	0.269	0.300	0.331	0.362	0.393	0.424	0.455	0.486	0.517	0.548	0.579	0.609	0.640	0.671	0.702	0.733	0.764	0.795	0.795
90	0.252	0.279	0.306	0.333	0.360	0.388	0.415	0.442	0.469	0.496	0.523	0.550	0.578	0.605	0.632	0.659	0.686	0.713	0.741	0.768	0.795	0.795
95	0.399	0.419	0.439	0.458	0.478	0.498	0.518	0.538	0.557	0.577	0.597	0.617	0.637	0.656	0.676	0.696	0.716	0.735	0.755	0.775	0.795	0.795
98	0.578	0.589	0.600	0.611	0.622	0.633	0.643	0.654	0.665	0.676	0.687	0.697	0.708	0.719	0.730	0.741	0.752	0.762	0.773	0.784	0.795	0.795

Zone 4

Mean Annual Runoff Coefficients (C Values) as a Function of DCIA Percentage and Non-DCIA Curve Number (CN)

NDCIA CN	Percent DCIA																					
	0	5	10	15	20	25	30	35	40	45	50	55	60	65	70	75	80	85	90	95	100	
30	0.004	0.045	0.086	0.127	0.168	0.209	0.250	0.291	0.332	0.373	0.414	0.455	0.496	0.536	0.577	0.618	0.659	0.700	0.741	0.782	0.823	0.823
35	0.007	0.048	0.089	0.129	0.170	0.211	0.252	0.293	0.333	0.374	0.415	0.456	0.497	0.537	0.578	0.619	0.660	0.701	0.741	0.782	0.823	0.823
40	0.011	0.051	0.092	0.133	0.173	0.214	0.254	0.295	0.336	0.376	0.417	0.458	0.498	0.539	0.579	0.620	0.661	0.701	0.742	0.782	0.823	0.823
45	0.016	0.056	0.096	0.137	0.177	0.217	0.258	0.298	0.339	0.379	0.419	0.460	0.500	0.540	0.581	0.621	0.662	0.702	0.742	0.783	0.823	0.823
50	0.022	0.062	0.102	0.142	0.182	0.222	0.262	0.302	0.342	0.382	0.423	0.463	0.503	0.543	0.583	0.623	0.663	0.703	0.743	0.783	0.823	0.823
55	0.030	0.070	0.109	0.149	0.189	0.228	0.268	0.308	0.347	0.387	0.427	0.466	0.506	0.546	0.585	0.625	0.664	0.704	0.744	0.783	0.823	0.823
60	0.040	0.080	0.119	0.158	0.197	0.236	0.275	0.314	0.353	0.393	0.432	0.471	0.510	0.549	0.588	0.627	0.667	0.706	0.745	0.784	0.823	0.823
65	0.054	0.092	0.131	0.169	0.208	0.246	0.285	0.323	0.362	0.400	0.438	0.477	0.515	0.554	0.592	0.631	0.669	0.708	0.746	0.785	0.823	0.823
70	0.071	0.109	0.147	0.184	0.222	0.259	0.297	0.335	0.372	0.410	0.447	0.485	0.522	0.560	0.598	0.635	0.673	0.710	0.748	0.785	0.823	0.823
75	0.096	0.132	0.168	0.205	0.241	0.277	0.314	0.350	0.387	0.423	0.459	0.496	0.532	0.568	0.605	0.641	0.678	0.714	0.750	0.787	0.823	0.823
80	0.130	0.165	0.199	0.234	0.268	0.303	0.338	0.372	0.407	0.442	0.476	0.511	0.546	0.580	0.615	0.650	0.684	0.719	0.754	0.788	0.823	0.823
85	0.182	0.214	0.246	0.278	0.310	0.342	0.374	0.406	0.438	0.470	0.502	0.534	0.566	0.599	0.631	0.663	0.695	0.727	0.759	0.791	0.823	0.823
90	0.266	0.294	0.322	0.350	0.378	0.406	0.433	0.461	0.489	0.517	0.545	0.573	0.600	0.628	0.656	0.684	0.712	0.740	0.767	0.795	0.823	0.823
95	0.429	0.449	0.469	0.488	0.508	0.528	0.547	0.567	0.587	0.606	0.626	0.646	0.665	0.685	0.705	0.725	0.744	0.764	0.784	0.803	0.823	0.823
98	0.616	0.626	0.636	0.647	0.657	0.667	0.678	0.688	0.699	0.709	0.719	0.730	0.740	0.750	0.761	0.771	0.782	0.792	0.802	0.813	0.823	0.823

Zone 5

Mean Annual Runoff Coefficients (C Values) as a Function of DCIA Percentage and Non-DCIA Curve Number (CN)

NDCIA CN	Percent DCIA																					
	0	5	10	15	20	25	30	35	40	45	50	55	60	65	70	75	80	85	90	95	100	
30	0.008	0.048	0.088	0.128	0.168	0.208	0.248	0.288	0.328	0.368	0.408	0.448	0.488	0.528	0.568	0.608	0.648	0.688	0.728	0.768	0.808	0.808
35	0.012	0.052	0.092	0.132	0.171	0.211	0.251	0.291	0.331	0.370	0.410	0.450	0.490	0.529	0.569	0.609	0.649	0.689	0.728	0.768	0.808	0.808
40	0.018	0.057	0.097	0.136	0.176	0.215	0.255	0.294	0.334	0.373	0.413	0.452	0.492	0.531	0.571	0.611	0.650	0.690	0.729	0.769	0.808	0.808
45	0.025	0.064	0.103	0.142	0.182	0.221	0.260	0.299	0.338	0.377	0.417	0.456	0.495	0.534	0.573	0.612	0.651	0.691	0.730	0.769	0.808	0.808
50	0.034	0.072	0.111	0.150	0.189	0.227	0.266	0.305	0.343	0.382	0.421	0.460	0.498	0.537	0.576	0.614	0.653	0.692	0.731	0.769	0.808	0.808
55	0.044	0.082	0.121	0.159	0.197	0.235	0.273	0.312	0.350	0.388	0.426	0.464	0.502	0.541	0.579	0.617	0.655	0.693	0.732	0.770	0.808	0.808
60	0.057	0.095	0.132	0.170	0.207	0.245	0.282	0.320	0.357	0.395	0.433	0.470	0.508	0.545	0.583	0.620	0.658	0.695	0.733	0.770	0.808	0.808
65	0.073	0.110	0.147	0.183	0.220	0.257	0.294	0.330	0.367	0.404	0.441	0.477	0.514	0.551	0.588	0.624	0.661	0.698	0.735	0.771	0.808	0.808
70	0.093	0.129	0.165	0.201	0.236	0.272	0.308	0.344	0.379	0.415	0.451	0.486	0.522	0.558	0.594	0.629	0.665	0.701	0.737	0.772	0.808	0.808
75	0.120	0.155	0.189	0.223	0.258	0.292	0.327	0.361	0.395	0.430	0.464	0.498	0.533	0.567	0.602	0.636	0.670	0.705	0.739	0.774	0.808	0.808
80	0.157	0.189	0.222	0.254	0.287	0.319	0.352	0.385	0.417	0.450	0.482	0.515	0.547	0.580	0.613	0.645	0.678	0.710	0.743	0.775	0.808	0.808
85	0.209	0.239	0.269	0.299	0.329	0.359	0.389	0.419	0.449	0.479	0.509	0.538	0.568	0.598	0.628	0.658	0.688	0.718	0.748	0.778	0.808	0.808
90	0.292	0.318	0.343	0.369	0.395	0.421	0.447	0.472	0.498	0.524	0.550	0.576	0.602	0.627	0.653	0.679	0.705	0.731	0.756	0.782	0.808	0.808
95	0.445	0.464	0.482	0.500	0.518	0.536	0.554	0.572	0.590	0.609	0.627	0.645	0.663	0.681	0.699	0.717	0.736	0.754	0.772	0.790	0.808	0.808
98	0.614	0.624	0.633	0.643	0.653	0.662	0.672	0.682	0.692	0.701	0.711	0.721	0.730	0.740	0.750	0.760	0.769	0.779	0.789	0.798	0.808	0.808

APPENDIX D

**CALCULATED PERFORMANCE EFFICIENCY
OF DRY RETENTION AS A FUNCTION OF
DCIA AND NON-DCIA CURVE NUMBER**

Mean Annual Mass Removal Efficiencies for 0.25-inches of Retention for Zone 1

NDCIA CN	Percent DCIA																			
	5	10	15	20	25	30	35	40	45	50	55	60	65	70	75	80	85	90	95	100
30	86.2	81.3	73.3	65.5	58.7	53.0	48.3	44.2	40.8	37.9	35.3	33.1	31.1	29.4	27.8	26.4	25.1	24.0	22.9	21.9
35	81.6	78.7	71.7	64.5	58.0	52.5	47.9	44.0	40.6	37.7	35.2	33.0	31.0	29.3	27.8	26.4	25.1	23.9	22.9	21.9
40	76.4	75.5	69.6	63.1	57.1	51.9	47.4	43.6	40.3	37.5	35.0	32.9	30.9	29.2	27.7	26.3	25.1	23.9	22.9	21.9
45	70.7	71.7	67.2	61.4	55.9	51.0	46.8	43.1	40.0	37.2	34.8	32.7	30.8	29.1	27.6	26.3	25.0	23.9	22.9	21.9
50	64.7	67.5	64.2	59.4	54.5	50.0	46.0	42.6	39.5	36.9	34.6	32.5	30.7	29.0	27.5	26.2	25.0	23.9	22.9	21.9
55	58.6	62.8	60.9	57.0	52.7	48.7	45.1	41.8	39.0	36.5	34.2	32.3	30.5	28.9	27.4	26.1	24.9	23.9	22.9	21.9
60	52.8	57.8	57.1	54.2	50.7	47.1	43.9	40.9	38.3	35.9	33.8	31.9	30.2	28.7	27.3	26.0	24.9	23.8	22.8	21.9
65	47.3	52.6	53.0	51.1	48.3	45.3	42.5	39.8	37.4	35.3	33.3	31.5	29.9	28.4	27.1	25.9	24.8	23.8	22.8	21.9
70	42.2	47.3	48.6	47.6	45.6	43.2	40.8	38.5	36.4	34.4	32.6	31.0	29.5	28.1	26.9	25.7	24.7	23.7	22.8	21.9
75	37.8	42.2	43.9	43.7	42.4	40.7	38.8	36.9	35.1	33.4	31.8	30.4	29.0	27.8	26.6	25.5	24.5	23.6	22.7	21.9
80	34.0	37.5	39.1	39.4	38.8	37.7	36.4	34.9	33.5	32.1	30.8	29.5	28.3	27.2	26.2	25.2	24.3	23.5	22.7	21.9
85	30.8	33.1	34.3	34.8	34.7	34.2	33.4	32.5	31.4	30.4	29.4	28.4	27.4	26.5	25.7	24.8	24.1	23.3	22.6	21.9
90	27.9	29.2	29.9	30.3	30.3	30.2	29.8	29.3	28.8	28.2	27.5	26.8	26.2	25.5	24.9	24.2	23.6	23.0	22.5	21.9
95	25.3	25.6	25.8	25.9	26.0	25.9	25.8	25.6	25.4	25.2	24.9	24.6	24.3	24.0	23.6	23.3	23.0	22.6	22.3	21.9
98	23.8	23.8	23.8	23.7	23.7	23.6	23.5	23.4	23.3	23.2	23.1	23.0	22.9	22.8	22.6	22.5	22.4	22.2	22.1	21.9

Mean Annual Mass Removal Efficiencies for 0.50-inches of Retention for Zone 1

NDCIA CN	Percent DCIA																			
	5	10	15	20	25	30	35	40	45	50	55	60	65	70	75	80	85	90	95	100
30	91.8	91.5	88.3	84.0	79.5	75.0	70.7	66.6	62.9	59.6	56.5	53.6	51.1	48.7	46.6	44.6	42.8	41.1	39.6	38.1
35	88.2	89.1	86.6	82.8	78.6	74.3	70.1	66.2	62.6	59.3	56.3	53.5	51.0	48.7	46.5	44.6	42.8	41.1	39.6	38.1
40	84.0	86.3	84.4	81.2	77.4	73.4	69.4	65.7	62.2	59.0	56.0	53.3	50.8	48.5	46.4	44.5	42.7	41.1	39.6	38.1
45	79.6	82.9	81.9	79.3	75.9	72.2	68.5	65.0	61.7	58.6	55.7	53.0	50.6	48.4	46.3	44.4	42.7	41.0	39.5	38.1
50	74.8	79.1	79.0	77.0	74.1	70.8	67.4	64.1	61.0	58.0	55.3	52.7	50.4	48.2	46.2	44.3	42.6	41.0	39.5	38.1
55	70.1	74.9	75.6	74.2	71.9	69.1	66.1	63.0	60.1	57.3	54.7	52.3	50.0	47.9	46.0	44.2	42.5	40.9	39.5	38.1
60	65.5	70.4	71.7	71.1	69.4	67.0	64.4	61.7	59.1	56.5	54.1	51.8	49.6	47.6	45.8	44.0	42.4	40.9	39.5	38.1
65	61.0	65.8	67.5	67.6	66.4	64.7	62.5	60.2	57.8	55.5	53.3	51.1	49.1	47.2	45.5	43.8	42.3	40.8	39.4	38.1
70	56.7	61.1	63.1	63.6	63.1	61.9	60.2	58.3	56.3	54.3	52.3	50.3	48.5	46.8	45.1	43.5	42.1	40.7	39.4	38.1
75	52.7	56.6	58.6	59.3	59.3	58.6	57.5	56.0	54.4	52.7	51.0	49.3	47.7	46.1	44.6	43.2	41.8	40.5	39.3	38.1
80	49.1	52.2	54.1	55.0	55.2	54.9	54.2	53.2	52.1	50.8	49.4	48.0	46.6	45.3	44.0	42.7	41.5	40.3	39.2	38.1
85	46.1	48.3	49.7	50.5	50.8	50.8	50.5	49.9	49.2	48.3	47.3	46.3	45.2	44.2	43.1	42.1	41.0	40.0	39.1	38.1
90	43.5	44.8	45.6	46.1	46.4	46.5	46.4	46.1	45.7	45.2	44.6	44.0	43.3	42.6	41.9	41.1	40.4	39.6	38.9	38.1
95	41.1	41.5	41.8	41.9	42.0	42.1	42.0	41.9	41.8	41.6	41.3	41.1	40.8	40.4	40.1	39.7	39.3	38.9	38.5	38.1
98	39.8	39.8	39.8	39.8	39.8	39.7	39.7	39.6	39.5	39.4	39.3	39.2	39.1	39.0	38.9	38.7	38.6	38.4	38.3	38.1

Mean Annual Mass Removal Efficiencies for 0.75-inches of Retention for Zone 1

NDCIA CN	Percent DCIA																			
	5	10	15	20	25	30	35	40	45	50	55	60	65	70	75	80	85	90	95	100
30	94.0	94.9	93.4	91.0	88.1	85.0	81.8	78.7	75.5	72.6	69.7	67.0	64.5	62.1	59.8	57.7	55.7	53.8	52.1	50.5
35	91.2	93.0	91.9	89.8	87.2	84.2	81.2	78.2	75.2	72.3	69.5	66.8	64.3	62.0	59.7	57.6	55.7	53.8	52.1	50.5
40	88.1	90.5	90.1	88.3	86.0	83.3	80.5	77.6	74.7	71.9	69.2	66.6	64.1	61.8	59.6	57.6	55.6	53.8	52.1	50.5
45	84.5	87.7	87.9	86.5	84.5	82.1	79.5	76.8	74.0	71.4	68.8	66.3	63.9	61.6	59.5	57.5	55.5	53.7	52.0	50.5
50	80.8	84.6	85.2	84.4	82.8	80.7	78.3	75.8	73.3	70.7	68.3	65.9	63.6	61.4	59.3	57.3	55.5	53.7	52.0	50.5
55	77.1	81.1	82.2	81.9	80.7	79.0	76.9	74.6	72.3	70.0	67.6	65.4	63.2	61.1	59.1	57.2	55.3	53.6	52.0	50.5
60	73.2	77.5	79.0	79.1	78.3	76.9	75.2	73.2	71.1	69.0	66.9	64.7	62.7	60.7	58.8	56.9	55.2	53.5	51.9	50.5
65	69.6	73.8	75.4	75.8	75.5	74.5	73.2	71.5	69.7	67.8	65.9	63.9	62.0	60.2	58.4	56.7	55.0	53.4	51.9	50.5
70	66.1	69.9	71.7	72.3	72.3	71.7	70.8	69.5	68.0	66.4	64.7	63.0	61.3	59.6	57.9	56.3	54.8	53.3	51.8	50.5
75	62.7	66.0	67.8	68.6	68.8	68.5	67.9	67.1	65.9	64.7	63.3	61.8	60.3	58.8	57.3	55.9	54.5	53.1	51.7	50.5
80	59.6	62.2	63.8	64.7	65.1	65.1	64.8	64.2	63.4	62.5	61.4	60.3	59.1	57.8	56.6	55.3	54.0	52.8	51.6	50.5
85	56.8	58.7	60.0	60.8	61.2	61.4	61.3	61.0	60.5	59.9	59.1	58.3	57.4	56.5	55.5	54.5	53.5	52.5	51.4	50.5
90	54.5	55.6	56.4	57.0	57.3	57.5	57.5	57.4	57.2	56.8	56.4	55.9	55.4	54.7	54.1	53.4	52.7	51.9	51.2	50.5
95	52.5	52.9	53.2	53.3	53.5	53.6	53.6	53.6	53.5	53.4	53.2	53.0	52.8	52.5	52.2	51.9	51.6	51.2	50.8	50.5
98	51.7	51.7	51.7	51.7	51.7	51.7	51.7	51.6	51.6	51.5	51.4	51.3	51.3	51.2	51.1	51.0	50.8	50.7	50.6	50.5

Mean Annual Mass Removal Efficiencies for 1.00-inches of Retention for Zone 1

NDCIA CN	Percent DCIA																			
	5	10	15	20	25	30	35	40	45	50	55	60	65	70	75	80	85	90	95	100
30	95.3	96.5	95.9	94.4	92.5	90.3	87.9	85.5	83.1	80.6	78.2	75.8	73.6	71.4	69.2	67.2	65.3	63.4	61.6	60.0
35	93.1	94.9	94.6	93.3	91.6	89.5	87.3	85.0	82.7	80.3	77.9	75.6	73.4	71.2	69.1	67.1	65.2	63.4	61.6	60.0
40	90.7	93.0	93.0	92.0	90.5	88.6	86.6	84.4	82.1	79.9	77.6	75.4	73.2	71.1	69.0	67.0	65.2	63.3	61.6	60.0
45	88.0	90.7	91.0	90.5	89.2	87.5	85.6	83.6	81.5	79.3	77.2	75.0	72.9	70.9	68.8	66.9	65.1	63.3	61.6	60.0
50	85.0	88.0	88.8	88.6	87.6	86.2	84.5	82.7	80.7	78.7	76.6	74.6	72.6	70.6	68.6	66.8	65.0	63.2	61.6	60.0
55	81.8	85.3	86.4	86.3	85.7	84.6	83.2	81.5	79.8	77.9	75.9	74.0	72.1	70.2	68.4	66.6	64.8	63.1	61.5	60.0
60	78.7	82.3	83.6	83.9	83.5	82.7	81.5	80.1	78.6	76.9	75.1	73.4	71.6	69.8	68.0	66.3	64.7	63.0	61.5	60.0
65	75.6	79.1	80.6	81.2	81.0	80.5	79.6	78.5	77.2	75.7	74.1	72.5	70.9	69.3	67.6	66.0	64.4	62.9	61.4	60.0
70	72.7	75.9	77.5	78.2	78.3	78.0	77.4	76.5	75.5	74.2	72.9	71.5	70.1	68.6	67.1	65.6	64.2	62.7	61.3	60.0
75	69.9	72.7	74.2	75.0	75.3	75.2	74.8	74.2	73.4	72.5	71.4	70.3	69.1	67.8	66.5	65.1	63.8	62.5	61.2	60.0
80	67.2	69.5	70.8	71.7	72.1	72.1	72.0	71.6	71.1	70.4	69.6	68.7	67.8	66.7	65.6	64.5	63.4	62.2	61.1	60.0
85	64.8	66.5	67.6	68.3	68.7	68.9	68.9	68.7	68.4	68.0	67.5	66.8	66.1	65.4	64.5	63.7	62.8	61.8	60.9	60.0
90	62.7	63.7	64.4	65.0	65.3	65.5	65.6	65.6	65.5	65.2	65.0	64.6	64.2	63.7	63.1	62.6	61.9	61.3	60.6	60.0
95	61.1	61.5	61.8	62.0	62.1	62.2	62.3	62.3	62.3	62.2	62.1	62.0	61.8	61.6	61.4	61.2	60.9	60.6	60.3	60.0
98	60.7	60.7	60.7	60.8	60.8	60.8	60.8	60.8	60.7	60.7	60.7	60.6	60.6	60.5	60.4	60.3	60.3	60.2	60.1	60.0

Mean Annual Mass Removal Efficiencies for 1.25-inches of Retention for Zone 1

NDCIA CN	Percent DCIA																			
	5	10	15	20	25	30	35	40	45	50	55	60	65	70	75	80	85	90	95	100
30	96.1	97.3	97.2	96.3	94.9	93.4	91.6	89.7	87.8	85.8	83.8	81.8	79.9	77.9	76.0	74.2	72.4	70.6	68.9	67.3
35	94.5	96.1	96.2	95.4	94.1	92.7	91.0	89.2	87.4	85.5	83.5	81.6	79.7	77.8	75.9	74.1	72.3	70.6	68.9	67.3
40	92.5	94.5	94.8	94.2	93.2	91.9	90.3	88.6	86.9	85.0	83.2	81.3	79.5	77.6	75.8	74.0	72.3	70.6	68.9	67.3
45	90.4	92.7	93.2	92.8	92.0	90.9	89.4	87.9	86.3	84.5	82.8	81.0	79.2	77.4	75.6	73.9	72.2	70.5	68.9	67.3
50	88.0	90.6	91.3	91.2	90.6	89.7	88.4	87.0	85.5	83.9	82.2	80.5	78.8	77.1	75.4	73.7	72.1	70.4	68.9	67.3
55	85.4	88.2	89.2	89.3	88.9	88.2	87.2	86.0	84.6	83.1	81.6	80.0	78.4	76.7	75.1	73.5	71.9	70.3	68.8	67.3
60	82.7	85.7	86.9	87.2	87.0	86.5	85.7	84.7	83.5	82.2	80.8	79.3	77.8	76.3	74.8	73.2	71.7	70.2	68.8	67.3
65	80.1	83.1	84.4	84.9	84.9	84.5	83.9	83.1	82.1	81.0	79.8	78.5	77.1	75.7	74.3	72.9	71.5	70.1	68.7	67.3
70	77.6	80.3	81.7	82.4	82.5	82.4	81.9	81.3	80.6	79.7	78.6	77.5	76.3	75.1	73.8	72.5	71.2	69.9	68.6	67.3
75	75.2	77.6	79.0	79.7	80.0	79.9	79.7	79.3	78.7	78.0	77.2	76.3	75.3	74.2	73.1	72.0	70.9	69.7	68.5	67.3
80	73.0	74.9	76.1	76.8	77.2	77.3	77.3	77.0	76.6	76.1	75.5	74.8	74.0	73.2	72.3	71.4	70.4	69.4	68.4	67.3
85	70.9	72.3	73.3	73.9	74.3	74.5	74.6	74.5	74.3	73.9	73.5	73.1	72.5	71.9	71.2	70.5	69.8	69.0	68.2	67.3
90	69.2	70.0	70.6	71.1	71.4	71.6	71.7	71.7	71.7	71.5	71.3	71.1	70.7	70.4	70.0	69.5	69.0	68.5	67.9	67.3
95	67.8	68.1	68.4	68.6	68.7	68.9	68.9	69.0	69.0	69.0	68.9	68.9	68.7	68.6	68.5	68.3	68.1	67.8	67.6	67.3
98	67.7	67.7	67.7	67.8	67.8	67.8	67.8	67.8	67.8	67.8	67.8	67.8	67.7	67.7	67.6	67.6	67.5	67.5	67.4	67.3

Mean Annual Mass Removal Efficiencies for 1.50-inches of Retention for Zone 1

NDCIA CN	Percent DCIA																			
	5	10	15	20	25	30	35	40	45	50	55	60	65	70	75	80	85	90	95	100
30	96.8	97.8	98.0	97.5	96.5	95.3	94.0	92.5	90.9	89.3	87.7	86.0	84.3	82.7	81.0	79.3	77.7	76.1	74.6	73.1
35	95.5	96.9	97.1	96.7	95.8	94.7	93.5	92.1	90.6	89.0	87.4	85.8	84.1	82.5	80.9	79.3	77.7	76.1	74.6	73.1
40	93.9	95.6	96.0	95.7	95.0	94.0	92.8	91.5	90.1	88.6	87.1	85.5	83.9	82.3	80.7	79.2	77.6	76.1	74.6	73.1
45	92.1	94.2	94.7	94.5	93.9	93.1	92.0	90.8	89.5	88.1	86.6	85.1	83.6	82.1	80.6	79.0	77.5	76.0	74.5	73.1
50	90.3	92.5	93.1	93.1	92.7	92.0	91.1	90.0	88.8	87.5	86.1	84.7	83.3	81.8	80.3	78.9	77.4	75.9	74.5	73.1
55	88.2	90.5	91.3	91.4	91.2	90.7	89.9	89.0	87.9	86.8	85.5	84.2	82.8	81.5	80.1	78.6	77.2	75.8	74.4	73.1
60	85.9	88.3	89.3	89.6	89.6	89.2	88.6	87.8	86.9	85.9	84.7	83.5	82.3	81.0	79.7	78.4	77.0	75.7	74.4	73.1
65	83.5	86.0	87.2	87.7	87.7	87.5	87.0	86.4	85.7	84.8	83.8	82.8	81.7	80.5	79.3	78.1	76.8	75.6	74.3	73.1
70	81.4	83.7	85.0	85.5	85.7	85.6	85.3	84.8	84.2	83.5	82.7	81.8	80.9	79.9	78.8	77.7	76.5	75.4	74.2	73.1
75	79.4	81.4	82.5	83.2	83.5	83.5	83.3	83.0	82.6	82.1	81.4	80.7	79.9	79.1	78.1	77.2	76.2	75.2	74.1	73.1
80	77.4	79.1	80.1	80.8	81.1	81.2	81.2	81.0	80.8	80.4	79.9	79.4	78.8	78.1	77.3	76.5	75.7	74.9	74.0	73.1
85	75.7	76.9	77.7	78.3	78.6	78.8	78.9	78.9	78.7	78.5	78.2	77.8	77.4	76.9	76.3	75.8	75.1	74.5	73.8	73.1
90	74.2	74.9	75.4	75.9	76.2	76.4	76.5	76.5	76.5	76.4	76.3	76.1	75.8	75.5	75.2	74.8	74.4	74.0	73.6	73.1
95	73.1	73.3	73.6	73.8	73.9	74.0	74.1	74.2	74.2	74.2	74.2	74.2	74.1	74.0	73.9	73.8	73.6	73.5	73.3	73.1
98	73.1	73.1	73.2	73.2	73.3	73.3	73.3	73.3	73.3	73.3	73.3	73.3	73.3	73.3	73.3	73.2	73.2	73.2	73.1	73.1

Mean Annual Mass Removal Efficiencies for 0.25-inches of Retention in Zone 2

NDCIA CN	Percent DCIA																			
	5	10	15	20	25	30	35	40	45	50	55	60	65	70	75	80	85	90	95	100
30	94.4	90.4	83.0	75.1	68.0	61.9	56.6	52.1	48.3	44.9	42.0	39.4	37.2	35.1	33.3	31.7	30.2	28.8	27.6	26.4
35	91.8	88.8	82.0	74.5	67.6	61.5	56.4	51.9	48.1	44.8	41.9	39.4	37.1	35.1	33.3	31.7	30.2	28.8	27.6	26.4
40	88.2	86.6	80.6	73.5	66.9	61.1	56.0	51.7	47.9	44.7	41.8	39.3	37.1	35.0	33.2	31.6	30.2	28.8	27.6	26.4
45	83.9	83.8	78.7	72.3	66.1	60.4	55.6	51.4	47.7	44.5	41.7	39.2	37.0	35.0	33.2	31.6	30.1	28.8	27.6	26.4
50	78.8	80.4	76.4	70.7	64.9	59.6	55.0	50.9	47.3	44.2	41.5	39.0	36.8	34.9	33.1	31.5	30.1	28.8	27.6	26.4
55	73.2	76.4	73.6	68.7	63.5	58.6	54.2	50.3	46.9	43.9	41.2	38.8	36.7	34.8	33.0	31.5	30.1	28.7	27.5	26.4
60	67.4	71.8	70.2	66.3	61.7	57.3	53.2	49.6	46.3	43.4	40.8	38.6	36.5	34.6	32.9	31.4	30.0	28.7	27.5	26.4
65	61.4	66.7	66.3	63.4	59.5	55.6	51.9	48.6	45.5	42.9	40.4	38.2	36.2	34.4	32.8	31.3	29.9	28.7	27.5	26.4
70	55.7	61.1	61.8	59.8	56.8	53.5	50.4	47.3	44.6	42.1	39.8	37.7	35.9	34.1	32.6	31.1	29.8	28.6	27.5	26.4
75	50.1	55.2	56.5	55.6	53.5	50.9	48.3	45.7	43.3	41.1	39.0	37.1	35.4	33.8	32.3	30.9	29.7	28.5	27.4	26.4
80	45.0	49.1	50.7	50.6	49.4	47.6	45.6	43.6	41.6	39.7	37.9	36.2	34.7	33.2	31.9	30.7	29.5	28.4	27.4	26.4
85	40.3	43.2	44.5	44.8	44.3	43.4	42.1	40.7	39.2	37.8	36.3	35.0	33.7	32.5	31.3	30.2	29.2	28.2	27.3	26.4
90	36.0	37.5	38.3	38.6	38.5	38.1	37.5	36.7	35.9	35.0	34.0	33.1	32.2	31.3	30.4	29.5	28.7	27.9	27.2	26.4
95	31.7	32.1	32.3	32.4	32.3	32.2	32.0	31.7	31.4	31.0	30.6	30.2	29.7	29.3	28.8	28.3	27.9	27.4	26.9	26.4
98	29.3	29.3	29.2	29.1	29.0	28.9	28.8	28.6	28.5	28.3	28.2	28.0	27.8	27.7	27.5	27.3	27.1	26.9	26.6	26.4

Mean Annual Mass Removal Efficiencies for 0.50-inches of Retention in Zone 2

NDCIA CN	Percent DCIA																			
	5	10	15	20	25	30	35	40	45	50	55	60	65	70	75	80	85	90	95	100
30	97.0	96.7	94.8	91.7	87.9	83.8	79.7	75.7	71.9	68.4	65.2	62.1	59.4	56.9	54.5	52.3	50.3	48.4	46.7	45.1
35	95.2	95.5	93.8	90.9	87.3	83.4	79.3	75.4	71.7	68.3	65.0	62.1	59.3	56.8	54.4	52.3	50.3	48.4	46.7	45.1
40	92.9	94.0	92.5	89.9	86.5	82.7	78.9	75.1	71.4	68.0	64.9	61.9	59.2	56.7	54.4	52.2	50.2	48.4	46.7	45.1
45	90.2	91.9	90.9	88.6	85.5	81.9	78.2	74.6	71.1	67.7	64.6	61.7	59.1	56.6	54.3	52.2	50.2	48.4	46.7	45.1
50	86.7	89.2	88.9	87.0	84.2	80.9	77.4	73.9	70.5	67.3	64.3	61.5	58.9	56.5	54.2	52.1	50.2	48.3	46.6	45.1
55	82.7	86.1	86.4	84.9	82.6	79.6	76.4	73.1	69.9	66.8	63.9	61.2	58.6	56.3	54.1	52.0	50.1	48.3	46.6	45.1
60	78.5	82.6	83.4	82.5	80.6	78.0	75.1	72.1	69.1	66.1	63.4	60.8	58.3	56.0	53.9	51.9	50.0	48.2	46.6	45.1
65	74.2	78.6	79.8	79.5	78.1	76.0	73.5	70.7	68.0	65.3	62.7	60.2	57.9	55.7	53.6	51.7	49.9	48.2	46.6	45.1
70	69.8	74.2	75.8	76.0	75.2	73.5	71.4	69.1	66.6	64.2	61.8	59.5	57.3	55.3	53.3	51.4	49.7	48.1	46.5	45.1
75	65.4	69.6	71.4	71.9	71.5	70.4	68.8	66.9	64.9	62.7	60.6	58.6	56.6	54.7	52.8	51.1	49.5	47.9	46.5	45.1
80	61.4	64.9	66.6	67.3	67.2	66.5	65.5	64.1	62.5	60.8	59.0	57.3	55.5	53.9	52.2	50.7	49.2	47.7	46.4	45.1
85	57.6	60.1	61.6	62.2	62.3	62.0	61.3	60.4	59.3	58.1	56.8	55.4	54.0	52.7	51.3	50.0	48.7	47.4	46.2	45.1
90	54.1	55.4	56.2	56.7	56.8	56.7	56.4	55.9	55.2	54.5	53.6	52.8	51.8	50.9	49.9	48.9	47.9	46.9	46.0	45.1
95	50.1	50.5	50.7	50.8	50.8	50.8	50.6	50.4	50.2	49.9	49.5	49.1	48.7	48.2	47.7	47.2	46.7	46.1	45.6	45.1
98	47.8	47.7	47.7	47.6	47.6	47.5	47.4	47.2	47.1	46.9	46.8	46.6	46.5	46.3	46.1	45.9	45.7	45.5	45.3	45.1

Mean Annual Mass Removal Efficiencies for 0.75-inches of Retention in Zone 2

NDCIA CN	Percent DCIA																			
	5	10	15	20	25	30	35	40	45	50	55	60	65	70	75	80	85	90	95	100
30	97.9	98.2	97.5	96.2	94.4	92.1	89.6	86.9	84.1	81.3	78.5	75.9	73.3	70.9	68.5	66.3	64.2	62.2	60.4	58.6
35	96.7	97.3	96.8	95.6	93.8	91.7	89.2	86.6	83.8	81.1	78.4	75.7	73.2	70.8	68.5	66.3	64.2	62.2	60.4	58.6
40	95.0	96.1	95.9	94.8	93.1	91.1	88.7	86.2	83.5	80.8	78.2	75.6	73.1	70.7	68.4	66.2	64.2	62.2	60.4	58.6
45	93.0	94.7	94.6	93.7	92.2	90.3	88.1	85.6	83.1	80.5	77.9	75.4	72.9	70.6	68.3	66.2	64.1	62.2	60.4	58.6
50	90.7	92.8	93.1	92.4	91.1	89.3	87.3	85.0	82.5	80.0	77.5	75.1	72.7	70.4	68.2	66.1	64.0	62.1	60.3	58.6
55	88.0	90.6	91.1	90.7	89.7	88.1	86.3	84.1	81.8	79.4	77.0	74.7	72.4	70.1	68.0	65.9	64.0	62.1	60.3	58.6
60	84.8	87.9	88.8	88.7	88.0	86.7	85.0	83.0	80.9	78.7	76.5	74.2	72.0	69.8	67.8	65.8	63.8	62.0	60.3	58.6
65	81.5	84.9	86.2	86.3	85.8	84.8	83.4	81.7	79.8	77.8	75.7	73.6	71.5	69.5	67.5	65.5	63.7	61.9	60.2	58.6
70	78.1	81.7	83.1	83.5	83.2	82.5	81.4	80.0	78.4	76.6	74.7	72.8	70.9	68.9	67.1	65.2	63.5	61.8	60.2	58.6
75	74.9	78.1	79.6	80.2	80.2	79.8	79.0	77.9	76.5	75.0	73.4	71.7	70.0	68.3	66.5	64.8	63.2	61.6	60.1	58.6
80	71.6	74.3	75.8	76.5	76.7	76.5	76.0	75.2	74.1	73.0	71.7	70.3	68.8	67.3	65.8	64.3	62.8	61.4	60.0	58.6
85	68.6	70.6	71.8	72.5	72.8	72.7	72.4	71.9	71.2	70.3	69.3	68.3	67.1	65.9	64.7	63.5	62.2	61.0	59.8	58.6
90	65.7	66.9	67.7	68.1	68.3	68.3	68.2	67.9	67.5	66.9	66.3	65.6	64.9	64.0	63.2	62.3	61.4	60.5	59.5	58.6
95	62.7	63.0	63.2	63.3	63.4	63.4	63.3	63.2	63.0	62.8	62.5	62.2	61.8	61.4	61.0	60.5	60.1	59.6	59.1	58.6
98	60.8	60.8	60.8	60.7	60.7	60.6	60.5	60.4	60.3	60.2	60.1	59.9	59.8	59.6	59.5	59.3	59.2	59.0	58.8	58.6

Mean Annual Mass Removal Efficiencies for 1.00-inches of Retention in Zone 2

NDCIA CN	Percent DCIA																			
	5	10	15	20	25	30	35	40	45	50	55	60	65	70	75	80	85	90	95	100
30	98.5	98.8	98.5	97.9	96.9	95.6	94.1	92.3	90.4	88.4	86.3	84.2	82.1	80.0	77.9	75.9	74.0	72.2	70.3	68.6
35	97.5	98.2	98.0	97.4	96.5	95.3	93.7	92.0	90.2	88.2	86.2	84.1	82.0	79.9	77.9	75.9	74.0	72.1	70.3	68.6
40	96.4	97.3	97.2	96.8	95.9	94.8	93.3	91.7	89.9	87.9	85.9	83.9	81.8	79.8	77.8	75.8	73.9	72.1	70.3	68.6
45	94.8	96.1	96.3	96.0	95.2	94.1	92.7	91.2	89.4	87.6	85.6	83.6	81.6	79.6	77.7	75.8	73.9	72.1	70.3	68.6
50	93.0	94.8	95.2	94.9	94.3	93.3	92.0	90.5	88.9	87.1	85.3	83.3	81.4	79.5	77.5	75.6	73.8	72.0	70.3	68.6
55	91.0	93.2	93.7	93.6	93.1	92.3	91.1	89.8	88.2	86.6	84.8	82.9	81.1	79.2	77.3	75.5	73.7	72.0	70.2	68.6
60	88.8	91.2	92.0	92.0	91.7	91.0	90.0	88.8	87.4	85.9	84.2	82.4	80.7	78.9	77.1	75.3	73.6	71.9	70.2	68.6
65	86.2	88.9	89.9	90.2	90.0	89.5	88.7	87.6	86.4	85.0	83.4	81.8	80.2	78.5	76.8	75.1	73.4	71.8	70.2	68.6
70	83.6	86.4	87.5	88.0	88.0	87.6	86.9	86.1	85.1	83.8	82.5	81.0	79.5	77.9	76.4	74.8	73.2	71.6	70.1	68.6
75	81.0	83.6	84.9	85.5	85.6	85.3	84.9	84.2	83.4	82.4	81.2	80.0	78.6	77.2	75.8	74.3	72.9	71.5	70.0	68.6
80	78.6	80.8	82.0	82.5	82.8	82.7	82.4	81.9	81.3	80.5	79.6	78.5	77.4	76.3	75.0	73.8	72.5	71.2	69.9	68.6
85	76.1	77.7	78.7	79.3	79.6	79.7	79.5	79.2	78.8	78.2	77.5	76.7	75.9	74.9	74.0	72.9	71.9	70.8	69.7	68.6
90	73.9	74.8	75.5	75.9	76.1	76.2	76.2	76.0	75.7	75.3	74.9	74.4	73.8	73.2	72.5	71.8	71.0	70.3	69.4	68.6
95	71.5	71.8	72.0	72.1	72.2	72.2	72.2	72.1	72.0	71.9	71.7	71.4	71.2	70.9	70.6	70.2	69.9	69.5	69.0	68.6
98	70.2	70.2	70.2	70.2	70.1	70.1	70.1	70.0	69.9	69.8	69.7	69.7	69.6	69.4	69.3	69.2	69.0	68.9	68.8	68.6

Mean Annual Mass Removal Efficiencies for 1.25-inches of Retention in Zone 2

NDCIA CN	Percent DCIA																			
	5	10	15	20	25	30	35	40	45	50	55	60	65	70	75	80	85	90	95	100
30	98.9	99.1	99.0	98.7	98.1	97.3	96.4	95.2	93.9	92.4	90.9	89.3	87.7	86.0	84.3	82.6	80.9	79.2	77.6	76.0
35	98.1	98.6	98.6	98.3	97.7	97.0	96.1	94.9	93.7	92.3	90.8	89.2	87.6	85.9	84.2	82.5	80.9	79.2	77.6	76.0
40	97.2	98.0	98.0	97.8	97.3	96.6	95.7	94.6	93.4	92.0	90.5	89.0	87.4	85.8	84.1	82.5	80.8	79.2	77.6	76.0
45	96.1	97.1	97.3	97.1	96.7	96.1	95.2	94.2	93.0	91.7	90.3	88.8	87.2	85.6	84.0	82.4	80.7	79.1	77.6	76.0
50	94.7	96.0	96.4	96.3	96.0	95.4	94.6	93.6	92.5	91.3	89.9	88.5	87.0	85.4	83.8	82.2	80.7	79.1	77.5	76.0
55	93.0	94.8	95.3	95.3	95.1	94.6	93.9	93.0	91.9	90.8	89.5	88.1	86.7	85.2	83.6	82.1	80.6	79.0	77.5	76.0
60	91.3	93.3	94.0	94.1	94.0	93.6	92.9	92.2	91.2	90.1	88.9	87.7	86.3	84.9	83.4	81.9	80.4	78.9	77.5	76.0
65	89.4	91.6	92.4	92.7	92.6	92.3	91.8	91.1	90.3	89.3	88.3	87.1	85.8	84.5	83.1	81.7	80.3	78.8	77.4	76.0
70	87.5	89.6	90.6	91.0	91.0	90.8	90.4	89.8	89.1	88.3	87.4	86.3	85.2	83.9	82.7	81.4	80.0	78.7	77.3	76.0
75	85.4	87.4	88.5	89.0	89.1	89.0	88.7	88.3	87.7	87.0	86.2	85.3	84.3	83.3	82.1	80.9	79.7	78.5	77.3	76.0
80	83.4	85.2	86.2	86.7	86.9	86.9	86.7	86.4	86.0	85.5	84.8	84.1	83.3	82.3	81.4	80.4	79.3	78.2	77.1	76.0
85	81.6	82.9	83.7	84.2	84.4	84.5	84.4	84.2	84.0	83.6	83.1	82.5	81.9	81.2	80.4	79.6	78.8	77.9	76.9	76.0
90	79.7	80.5	81.0	81.4	81.6	81.7	81.7	81.7	81.5	81.3	80.9	80.6	80.1	79.7	79.1	78.6	78.0	77.4	76.7	76.0
95	77.9	78.2	78.4	78.5	78.6	78.7	78.7	78.6	78.6	78.4	78.3	78.2	78.0	77.8	77.5	77.3	77.0	76.7	76.3	76.0
98	77.1	77.1	77.1	77.1	77.1	77.1	77.0	77.0	76.9	76.9	76.8	76.8	76.7	76.6	76.5	76.4	76.3	76.2	76.1	76.0

Mean Annual Mass Removal Efficiencies for 1.50-inches of Retention in Zone 2

NDCIA CN	Percent DCIA																			
	5	10	15	20	25	30	35	40	45	50	55	60	65	70	75	80	85	90	95	100
30	99.2	99.4	99.3	99.1	98.7	98.2	97.6	96.8	95.9	94.9	93.7	92.5	91.3	89.9	88.6	87.2	85.7	84.3	82.9	81.5
35	98.6	99.0	99.0	98.8	98.5	98.0	97.4	96.6	95.7	94.7	93.6	92.4	91.2	89.8	88.5	87.1	85.7	84.3	82.9	81.5
40	97.8	98.4	98.5	98.4	98.1	97.6	97.1	96.3	95.5	94.5	93.4	92.2	91.0	89.7	88.4	87.1	85.7	84.3	82.9	81.5
45	96.9	97.8	98.0	97.9	97.6	97.2	96.7	96.0	95.1	94.2	93.1	92.0	90.8	89.6	88.3	87.0	85.6	84.2	82.9	81.5
50	95.9	96.9	97.2	97.2	97.0	96.7	96.2	95.5	94.7	93.8	92.8	91.8	90.6	89.4	88.2	86.9	85.5	84.2	82.8	81.5
55	94.6	95.9	96.3	96.4	96.3	96.0	95.6	95.0	94.2	93.4	92.4	91.4	90.3	89.2	88.0	86.7	85.4	84.1	82.8	81.5
60	93.1	94.7	95.3	95.5	95.4	95.2	94.8	94.3	93.6	92.8	92.0	91.0	90.0	88.9	87.7	86.5	85.3	84.0	82.8	81.5
65	91.7	93.4	94.1	94.4	94.4	94.2	93.9	93.4	92.8	92.1	91.3	90.5	89.5	88.5	87.4	86.3	85.1	83.9	82.7	81.5
70	90.1	91.9	92.7	93.0	93.1	93.0	92.7	92.3	91.9	91.2	90.6	89.8	88.9	88.0	87.0	86.0	84.9	83.8	82.6	81.5
75	88.5	90.2	91.0	91.5	91.6	91.6	91.4	91.1	90.7	90.2	89.6	88.9	88.2	87.4	86.5	85.6	84.6	83.6	82.6	81.5
80	86.9	88.4	89.2	89.6	89.9	89.9	89.8	89.6	89.3	88.9	88.4	87.9	87.3	86.6	85.9	85.1	84.2	83.3	82.4	81.5
85	85.4	86.5	87.2	87.6	87.9	88.0	87.9	87.8	87.6	87.3	87.0	86.6	86.1	85.6	85.0	84.4	83.7	83.0	82.3	81.5
90	84.1	84.7	85.1	85.4	85.6	85.7	85.8	85.7	85.6	85.5	85.3	85.0	84.7	84.4	84.0	83.5	83.1	82.6	82.0	81.5
95	82.7	82.9	83.1	83.2	83.3	83.3	83.4	83.4	83.4	83.3	83.2	83.1	83.0	82.8	82.6	82.4	82.2	82.0	81.8	81.5
98	82.2	82.2	82.2	82.2	82.2	82.2	82.2	82.2	82.1	82.1	82.1	82.0	82.0	81.9	81.9	81.8	81.7	81.7	81.6	81.5

Mean Annual Mass Removal Efficiencies for 1.75-inches of Retention in Zone 2

NDCIA CN	Percent DCIA																			
	5	10	15	20	25	30	35	40	45	50	55	60	65	70	75	80	85	90	95	100
30	99.4	99.5	99.5	99.4	99.1	98.8	98.3	97.8	97.2	96.4	95.6	94.6	93.6	92.6	91.5	90.4	89.2	88.0	86.8	85.6
35	98.9	99.2	99.2	99.1	98.9	98.6	98.1	97.6	97.0	96.3	95.4	94.5	93.5	92.5	91.4	90.3	89.2	88.0	86.8	85.6
40	98.3	98.8	98.9	98.8	98.6	98.3	97.9	97.4	96.8	96.1	95.3	94.4	93.4	92.4	91.4	90.3	89.1	88.0	86.8	85.6
45	97.5	98.3	98.4	98.4	98.2	97.9	97.5	97.1	96.5	95.8	95.0	94.2	93.2	92.3	91.2	90.2	89.1	87.9	86.8	85.6
50	96.7	97.6	97.8	97.8	97.7	97.5	97.1	96.7	96.2	95.5	94.8	93.9	93.0	92.1	91.1	90.1	89.0	87.9	86.7	85.6
55	95.7	96.8	97.1	97.2	97.1	96.9	96.6	96.2	95.7	95.1	94.4	93.6	92.8	91.9	90.9	89.9	88.9	87.8	86.7	85.6
60	94.5	95.8	96.3	96.4	96.4	96.3	96.0	95.7	95.2	94.6	94.0	93.3	92.5	91.6	90.7	89.8	88.8	87.7	86.7	85.6
65	93.3	94.7	95.3	95.5	95.6	95.5	95.3	95.0	94.5	94.0	93.4	92.8	92.1	91.3	90.4	89.5	88.6	87.6	86.6	85.6
70	92.0	93.5	94.2	94.5	94.6	94.5	94.4	94.1	93.7	93.3	92.8	92.2	91.5	90.8	90.1	89.3	88.4	87.5	86.6	85.6
75	90.8	92.1	92.9	93.2	93.4	93.4	93.3	93.1	92.8	92.4	92.0	91.5	90.9	90.3	89.6	88.9	88.2	87.3	86.5	85.6
80	89.6	90.7	91.4	91.8	92.0	92.0	92.0	91.9	91.6	91.3	91.0	90.6	90.1	89.6	89.1	88.5	87.8	87.1	86.4	85.6
85	88.4	89.2	89.8	90.2	90.4	90.5	90.5	90.4	90.3	90.1	89.8	89.5	89.2	88.8	88.4	87.9	87.4	86.8	86.2	85.6
90	87.3	87.8	88.2	88.4	88.6	88.7	88.8	88.7	88.7	88.6	88.4	88.2	88.0	87.8	87.5	87.2	86.8	86.4	86.0	85.6
95	86.2	86.4	86.6	86.7	86.8	86.8	86.9	86.9	86.9	86.8	86.8	86.7	86.7	86.6	86.4	86.3	86.1	86.0	85.8	85.6
98	86.0	86.0	86.0	86.0	86.1	86.1	86.1	86.0	86.0	86.0	86.0	86.0	85.9	85.9	85.9	85.8	85.8	85.7	85.6	85.6

Mean Annual Mass Removal Efficiencies for 2.00-inches of Retention in Zone 2

NDCIA CN	Percent DCIA																			
	5	10	15	20	25	30	35	40	45	50	55	60	65	70	75	80	85	90	95	100
30	99.5	99.7	99.6	99.6	99.4	99.1	98.8	98.4	97.9	97.4	96.8	96.1	95.3	94.4	93.6	92.6	91.7	90.7	89.7	88.7
35	99.2	99.4	99.4	99.4	99.2	99.0	98.6	98.2	97.8	97.3	96.6	95.9	95.2	94.4	93.5	92.6	91.6	90.7	89.7	88.7
40	98.6	99.0	99.1	99.1	98.9	98.7	98.4	98.0	97.6	97.1	96.5	95.8	95.1	94.3	93.4	92.5	91.6	90.6	89.7	88.7
45	98.0	98.6	98.8	98.7	98.6	98.4	98.1	97.8	97.4	96.9	96.3	95.6	94.9	94.1	93.3	92.5	91.5	90.6	89.6	88.7
50	97.3	98.1	98.3	98.3	98.2	98.0	97.8	97.5	97.1	96.6	96.1	95.4	94.7	94.0	93.2	92.4	91.5	90.6	89.6	88.7
55	96.6	97.4	97.7	97.8	97.7	97.6	97.4	97.1	96.7	96.3	95.8	95.2	94.5	93.8	93.0	92.2	91.4	90.5	89.6	88.7
60	95.6	96.6	97.0	97.1	97.1	97.0	96.9	96.6	96.3	95.9	95.4	94.9	94.2	93.6	92.8	92.1	91.3	90.4	89.6	88.7
65	94.5	95.7	96.2	96.4	96.5	96.4	96.3	96.0	95.7	95.4	94.9	94.4	93.9	93.3	92.6	91.9	91.1	90.3	89.5	88.7
70	93.5	94.7	95.3	95.5	95.7	95.6	95.5	95.3	95.1	94.8	94.4	93.9	93.4	92.9	92.3	91.6	90.9	90.2	89.5	88.7
75	92.5	93.6	94.2	94.5	94.7	94.7	94.7	94.5	94.3	94.0	93.7	93.3	92.9	92.4	91.9	91.3	90.7	90.1	89.4	88.7
80	91.5	92.5	93.1	93.4	93.6	93.7	93.6	93.5	93.4	93.2	92.9	92.6	92.2	91.8	91.4	90.9	90.4	89.9	89.3	88.7
85	90.6	91.3	91.8	92.1	92.3	92.4	92.4	92.4	92.3	92.1	91.9	91.7	91.4	91.1	90.8	90.4	90.0	89.6	89.2	88.7
90	89.7	90.1	90.5	90.7	90.9	91.0	91.0	91.0	91.0	90.9	90.8	90.6	90.5	90.3	90.1	89.9	89.6	89.3	89.0	88.7
95	88.9	89.1	89.2	89.3	89.4	89.5	89.5	89.5	89.5	89.5	89.5	89.4	89.4	89.3	89.2	89.2	89.0	88.9	88.8	88.7
98	88.8	88.8	88.9	88.9	88.9	88.9	88.9	88.9	88.9	88.9	88.9	88.9	88.9	88.8	88.8	88.8	88.8	88.7	88.7	88.7

Mean Annual Mass Removal Efficiencies for 2.25-inches of Retention in Zone 2

NDCIA CN	Percent DCIA																			
	5	10	15	20	25	30	35	40	45	50	55	60	65	70	75	80	85	90	95	100
30	99.7	99.7	99.7	99.7	99.6	99.4	99.1	98.8	98.5	98.1	97.6	97.0	96.4	95.8	95.0	94.3	93.5	92.7	91.8	91.0
35	99.3	99.5	99.6	99.5	99.4	99.2	99.0	98.7	98.3	97.9	97.5	96.9	96.3	95.7	95.0	94.3	93.5	92.7	91.8	91.0
40	99.0	99.2	99.3	99.3	99.2	99.0	98.8	98.5	98.2	97.8	97.3	96.8	96.2	95.6	94.9	94.2	93.4	92.6	91.8	91.0
45	98.4	98.9	99.0	99.0	98.9	98.8	98.6	98.3	98.0	97.6	97.2	96.7	96.1	95.5	94.8	94.1	93.4	92.6	91.8	91.0
50	97.8	98.5	98.6	98.7	98.6	98.5	98.3	98.0	97.7	97.4	97.0	96.5	95.9	95.4	94.7	94.0	93.3	92.5	91.8	91.0
55	97.2	97.9	98.2	98.2	98.2	98.1	97.9	97.7	97.4	97.1	96.7	96.3	95.8	95.2	94.6	93.9	93.2	92.5	91.7	91.0
60	96.5	97.3	97.6	97.7	97.7	97.6	97.5	97.3	97.0	96.8	96.4	96.0	95.5	95.0	94.4	93.8	93.1	92.4	91.7	91.0
65	95.6	96.5	96.9	97.1	97.1	97.1	97.0	96.8	96.6	96.3	96.0	95.6	95.2	94.7	94.2	93.6	93.0	92.3	91.7	91.0
70	94.6	95.6	96.1	96.3	96.4	96.4	96.4	96.3	96.1	95.8	95.5	95.2	94.8	94.4	93.9	93.4	92.8	92.2	91.6	91.0
75	93.8	94.7	95.2	95.5	95.7	95.7	95.7	95.6	95.4	95.2	95.0	94.7	94.4	94.0	93.6	93.1	92.6	92.1	91.5	91.0
80	93.0	93.8	94.3	94.6	94.8	94.9	94.9	94.8	94.7	94.5	94.3	94.1	93.8	93.5	93.1	92.8	92.4	91.9	91.4	91.0
85	92.3	92.9	93.3	93.6	93.7	93.8	93.9	93.8	93.8	93.7	93.5	93.4	93.1	92.9	92.6	92.4	92.0	91.7	91.3	91.0
90	91.6	92.0	92.3	92.5	92.6	92.7	92.7	92.7	92.7	92.7	92.6	92.5	92.4	92.2	92.1	91.9	91.7	91.5	91.2	91.0
95	91.0	91.2	91.3	91.4	91.4	91.5	91.5	91.5	91.6	91.5	91.5	91.5	91.5	91.4	91.4	91.3	91.2	91.1	91.1	91.0
98	91.0	91.0	91.0	91.0	91.1	91.1	91.1	91.1	91.1	91.1	91.1	91.1	91.1	91.1	91.0	91.0	91.0	91.0	91.0	91.0

Mean Annual Mass Removal Efficiencies for 2.50-inches of Retention in Zone 2

NDCIA CN	Percent DCIA																			
	5	10	15	20	25	30	35	40	45	50	55	60	65	70	75	80	85	90	95	100
30	99.7	99.8	99.8	99.8	99.7	99.6	99.4	99.1	98.8	98.5	98.1	97.7	97.2	96.7	96.1	95.5	94.9	94.2	93.5	92.7
35	99.5	99.6	99.7	99.6	99.6	99.4	99.3	99.0	98.7	98.4	98.0	97.6	97.2	96.6	96.1	95.5	94.8	94.2	93.4	92.7
40	99.2	99.4	99.5	99.5	99.4	99.3	99.1	98.9	98.6	98.3	97.9	97.5	97.1	96.6	96.0	95.4	94.8	94.1	93.4	92.7
45	98.7	99.1	99.2	99.2	99.2	99.0	98.9	98.7	98.4	98.1	97.8	97.4	97.0	96.5	95.9	95.4	94.7	94.1	93.4	92.7
50	98.2	98.8	98.9	98.9	98.9	98.8	98.6	98.4	98.2	97.9	97.6	97.2	96.8	96.4	95.8	95.3	94.7	94.1	93.4	92.7
55	97.7	98.3	98.5	98.6	98.5	98.5	98.3	98.1	97.9	97.7	97.4	97.0	96.6	96.2	95.7	95.2	94.6	94.0	93.4	92.7
60	97.1	97.8	98.0	98.1	98.1	98.1	97.9	97.8	97.6	97.4	97.1	96.8	96.4	96.0	95.6	95.1	94.5	93.9	93.3	92.7
65	96.4	97.1	97.5	97.6	97.6	97.6	97.5	97.4	97.2	97.0	96.8	96.5	96.2	95.8	95.4	94.9	94.4	93.9	93.3	92.7
70	95.6	96.4	96.8	97.0	97.1	97.1	97.0	96.9	96.8	96.6	96.4	96.1	95.8	95.5	95.1	94.7	94.2	93.8	93.3	92.7
75	94.8	95.6	96.0	96.3	96.4	96.5	96.4	96.4	96.3	96.1	95.9	95.7	95.5	95.2	94.8	94.5	94.1	93.6	93.2	92.7
80	94.1	94.8	95.3	95.5	95.7	95.8	95.8	95.7	95.7	95.5	95.4	95.2	95.0	94.8	94.5	94.2	93.8	93.5	93.1	92.7
85	93.6	94.1	94.4	94.7	94.8	94.9	94.9	94.9	94.9	94.9	94.7	94.6	94.5	94.3	94.1	93.8	93.6	93.3	93.0	92.7
90	93.1	93.4	93.6	93.8	93.9	94.0	94.1	94.1	94.1	94.0	94.0	93.9	93.8	93.7	93.6	93.4	93.3	93.1	92.9	92.7
95	92.7	92.8	92.9	93.0	93.0	93.1	93.1	93.1	93.1	93.1	93.1	93.1	93.1	93.1	93.0	93.0	92.9	92.9	92.8	92.7
98	92.7	92.7	92.7	92.7	92.7	92.8	92.8	92.8	92.8	92.8	92.8	92.8	92.8	92.8	92.8	92.8	92.7	92.7	92.7	92.7

Mean Annual Mass Removal Efficiencies for 2.75-inches of Retention in Zone 2

NDCIA CN	Percent DCIA																			
	5	10	15	20	25	30	35	40	45	50	55	60	65	70	75	80	85	90	95	100
30	99.8	99.9	99.9	99.8	99.8	99.7	99.5	99.4	99.1	98.8	98.5	98.2	97.8	97.4	96.9	96.4	95.9	95.3	94.7	94.1
35	99.6	99.7	99.7	99.7	99.7	99.6	99.4	99.3	99.0	98.8	98.5	98.1	97.8	97.4	96.9	96.4	95.9	95.3	94.7	94.1
40	99.4	99.5	99.6	99.6	99.5	99.4	99.3	99.1	98.9	98.6	98.4	98.0	97.7	97.3	96.8	96.4	95.8	95.3	94.7	94.1
45	99.0	99.3	99.4	99.4	99.3	99.2	99.1	98.9	98.7	98.5	98.2	97.9	97.6	97.2	96.8	96.3	95.8	95.2	94.7	94.1
50	98.6	99.0	99.1	99.2	99.1	99.0	98.9	98.7	98.6	98.3	98.1	97.9	97.6	97.1	96.7	96.2	95.7	95.2	94.7	94.1
55	98.1	98.6	98.8	98.8	98.8	98.7	98.6	98.5	98.3	98.1	97.9	97.6	97.3	97.0	96.6	96.1	95.7	95.2	94.6	94.1
60	97.6	98.2	98.4	98.5	98.5	98.4	98.3	98.2	98.0	97.9	97.6	97.4	97.1	96.8	96.4	96.0	95.6	95.1	94.6	94.1
65	97.0	97.6	97.9	98.0	98.1	98.0	98.0	97.9	97.7	97.6	97.4	97.2	96.9	96.6	96.2	95.9	95.5	95.0	94.6	94.1
70	96.4	97.0	97.3	97.5	97.6	97.6	97.5	97.5	97.4	97.2	97.1	96.9	96.6	96.3	96.0	95.7	95.3	94.9	94.5	94.1
75	95.7	96.4	96.7	96.9	97.0	97.1	97.0	97.0	96.9	96.8	96.7	96.5	96.3	96.1	95.8	95.5	95.2	94.8	94.5	94.1
80	95.1	95.6	96.0	96.3	96.4	96.5	96.5	96.5	96.4	96.3	96.2	96.1	95.9	95.7	95.5	95.3	95.0	94.7	94.4	94.1
85	94.6	95.0	95.3	95.6	95.7	95.8	95.8	95.8	95.8	95.8	95.7	95.6	95.5	95.3	95.2	95.0	94.8	94.6	94.3	94.1
90	94.2	94.5	94.7	94.9	95.0	95.0	95.1	95.1	95.1	95.1	95.1	95.0	94.9	94.9	94.8	94.6	94.5	94.4	94.2	94.1
95	93.9	94.0	94.1	94.2	94.3	94.3	94.3	94.4	94.4	94.4	94.4	94.4	94.4	94.3	94.3	94.3	94.2	94.2	94.1	94.1
98	94.0	94.0	94.0	94.0	94.1	94.1	94.1	94.1	94.1	94.1	94.1	94.1	94.1	94.1	94.1	94.1	94.1	94.1	94.1	94.1

Mean Annual Mass Removal Efficiencies for 3.00-inches of Retention in Zone 2

NDCIA CN	Percent DCIA																			
	5	10	15	20	25	30	35	40	45	50	55	60	65	70	75	80	85	90	95	100
30	99.9	99.9	99.9	99.9	99.8	99.8	99.7	99.5	99.3	99.1	98.9	98.6	98.3	97.9	97.6	97.1	96.7	96.2	95.7	95.1
35	99.7	99.8	99.8	99.8	99.7	99.7	99.6	99.4	99.2	99.0	98.8	98.5	98.2	97.9	97.5	97.1	96.7	96.2	95.7	95.1
40	99.5	99.6	99.7	99.7	99.6	99.6	99.5	99.3	99.1	98.9	98.7	98.4	98.1	97.8	97.5	97.1	96.6	96.2	95.7	95.1
45	99.2	99.4	99.5	99.5	99.5	99.4	99.3	99.2	99.0	98.8	98.6	98.3	98.1	97.7	97.4	97.0	96.6	96.1	95.6	95.1
50	98.8	99.2	99.3	99.3	99.3	99.2	99.1	99.0	98.8	98.6	98.4	98.2	97.9	97.6	97.3	96.9	96.5	96.1	95.6	95.1
55	98.4	98.9	99.0	99.1	99.0	99.0	98.9	98.8	98.6	98.5	98.3	98.0	97.8	97.5	97.2	96.9	96.5	96.1	95.6	95.1
60	98.0	98.5	98.7	98.7	98.7	98.7	98.6	98.5	98.4	98.2	98.1	97.9	97.6	97.4	97.1	96.8	96.4	96.0	95.6	95.1
65	97.5	98.0	98.3	98.4	98.4	98.4	98.3	98.2	98.1	98.0	97.8	97.6	97.4	97.2	96.9	96.6	96.3	95.9	95.6	95.1
70	97.0	97.5	97.8	97.9	98.0	98.0	97.9	97.9	97.8	97.7	97.6	97.4	97.2	97.0	96.8	96.6	96.3	95.9	95.6	95.1
75	96.4	97.0	97.2	97.4	97.5	97.5	97.5	97.5	97.4	97.3	97.2	97.1	96.9	96.8	96.5	96.3	96.1	95.8	95.5	95.1
80	95.9	96.3	96.6	96.8	97.0	97.0	97.0	97.0	97.0	96.9	96.9	96.8	96.6	96.5	96.3	96.1	95.9	95.7	95.4	95.1
85	95.4	95.8	96.1	96.2	96.4	96.5	96.5	96.5	96.5	96.5	96.4	96.3	96.3	96.1	96.0	95.9	95.7	95.5	95.3	95.1
90	95.1	95.4	95.5	95.7	95.8	95.9	95.9	95.9	95.9	95.9	95.9	95.9	95.8	95.8	95.7	95.6	95.5	95.4	95.3	95.1
95	95.0	95.0	95.1	95.2	95.2	95.3	95.3	95.3	95.3	95.4	95.4	95.4	95.3	95.3	95.3	95.3	95.3	95.2	95.2	95.1
98	95.0	95.1	95.1	95.1	95.1	95.1	95.1	95.1	95.1	95.1	95.2	95.2	95.2	95.2	95.2	95.2	95.1	95.1	95.1	95.1

Mean Annual Mass Removal Efficiencies for 3.25-inches of Retention in Zone 2

NDCIA CN	Percent DCIA																			
	5	10	15	20	25	30	35	40	45	50	55	60	65	70	75	80	85	90	95	100
30	99.9	99.9	99.9	99.9	99.9	99.8	99.8	99.6	99.5	99.3	99.1	98.9	98.6	98.3	98.0	97.7	97.3	96.9	96.4	96.0
35	99.8	99.8	99.9	99.8	99.8	99.8	99.7	99.6	99.4	99.2	99.0	98.8	98.5	98.3	98.0	97.6	97.3	96.9	96.4	96.0
40	99.6	99.7	99.7	99.7	99.7	99.7	99.6	99.5	99.3	99.1	99.0	98.7	98.5	98.2	97.9	97.6	97.2	96.8	96.4	96.0
45	99.4	99.5	99.6	99.6	99.6	99.5	99.4	99.3	99.2	99.0	98.8	98.6	98.4	98.2	97.9	97.5	97.2	96.8	96.4	96.0
50	99.1	99.3	99.4	99.4	99.4	99.4	99.3	99.2	99.1	98.9	98.7	98.5	98.3	98.1	97.8	97.5	97.2	96.8	96.4	96.0
55	98.7	99.1	99.2	99.2	99.2	99.2	99.1	99.0	98.9	98.7	98.6	98.4	98.2	98.0	97.7	97.4	97.1	96.8	96.4	96.0
60	98.4	98.8	98.9	99.0	99.0	98.9	98.9	98.8	98.7	98.5	98.4	98.2	98.0	97.8	97.6	97.3	97.0	96.7	96.4	96.0
65	98.0	98.4	98.6	98.6	98.7	98.6	98.6	98.5	98.4	98.3	98.2	98.0	97.9	97.7	97.5	97.2	96.9	96.7	96.3	96.0
70	97.5	97.9	98.2	98.3	98.3	98.3	98.3	98.2	98.2	98.1	98.0	97.8	97.7	97.5	97.3	97.1	96.8	96.6	96.3	96.0
75	97.0	97.4	97.7	97.8	97.9	97.9	97.9	97.9	97.8	97.8	97.7	97.6	97.4	97.3	97.1	96.9	96.7	96.5	96.3	96.0
80	96.5	96.9	97.2	97.3	97.4	97.5	97.5	97.5	97.5	97.4	97.4	97.3	97.2	97.1	96.9	96.8	96.6	96.4	96.2	96.0
85	96.1	96.4	96.7	96.8	96.9	97.0	97.0	97.1	97.1	97.0	97.0	96.9	96.9	96.8	96.7	96.6	96.4	96.3	96.1	96.0
90	95.9	96.1	96.2	96.3	96.4	96.5	96.5	96.6	96.6	96.6	96.6	96.6	96.5	96.5	96.4	96.3	96.3	96.2	96.1	96.0
95	95.8	95.8	95.9	96.0	96.0	96.0	96.1	96.1	96.1	96.1	96.1	96.1	96.1	96.1	96.1	96.1	96.1	96.0	96.0	96.0
98	95.9	95.9	95.9	95.9	95.9	95.9	95.9	96.0	96.0	96.0	96.0	96.0	96.0	96.0	96.0	96.0	96.0	96.0	96.0	96.0

Mean Annual Mass Removal Efficiencies for 3.50-inches of Retention in Zone 2

NDCIA CN	Percent DCIA																			
	5	10	15	20	25	30	35	40	45	50	55	60	65	70	75	80	85	90	95	100
30	99.9	99.9	99.9	99.9	99.9	99.9	99.8	99.7	99.6	99.5	99.3	99.1	98.9	98.6	98.4	98.1	97.8	97.4	97.0	96.7
35	99.8	99.9	99.9	99.9	99.8	99.8	99.8	99.7	99.5	99.4	99.2	99.0	98.8	98.6	98.3	98.0	97.7	97.4	97.0	96.7
40	99.7	99.8	99.8	99.8	99.8	99.7	99.7	99.6	99.5	99.3	99.2	99.0	98.8	98.5	98.3	98.0	97.7	97.4	97.0	96.7
45	99.5	99.7	99.7	99.7	99.7	99.6	99.6	99.5	99.4	99.2	99.1	98.9	98.7	98.5	98.2	98.0	97.7	97.4	97.0	96.7
50	99.3	99.5	99.5	99.5	99.5	99.5	99.4	99.3	99.2	99.1	98.9	98.8	98.6	98.4	98.2	97.9	97.6	97.3	97.0	96.7
55	98.9	99.2	99.3	99.4	99.4	99.3	99.3	99.2	99.1	99.0	98.8	98.7	98.5	98.3	98.1	97.9	97.6	97.3	97.0	96.7
60	98.6	99.0	99.1	99.2	99.2	99.1	99.1	99.0	98.9	98.8	98.7	98.5	98.4	98.2	98.0	97.8	97.5	97.3	97.0	96.7
65	98.3	98.7	98.8	98.9	98.9	98.9	98.8	98.8	98.7	98.6	98.5	98.4	98.2	98.1	97.9	97.7	97.5	97.2	96.9	96.7
70	97.9	98.3	98.5	98.5	98.6	98.6	98.6	98.5	98.4	98.4	98.3	98.2	98.0	97.9	97.7	97.6	97.4	97.2	96.9	96.7
75	97.5	97.8	98.1	98.2	98.2	98.3	98.2	98.2	98.2	98.1	98.0	97.9	97.8	97.7	97.6	97.4	97.3	97.1	96.9	96.7
80	97.1	97.4	97.6	97.7	97.8	97.9	97.9	97.9	97.9	97.8	97.8	97.7	97.6	97.5	97.4	97.3	97.2	97.0	96.8	96.7
85	96.7	97.0	97.1	97.3	97.4	97.4	97.5	97.5	97.5	97.5	97.5	97.4	97.4	97.3	97.2	97.1	97.0	96.9	96.8	96.7
90	96.5	96.6	96.8	96.9	97.0	97.0	97.1	97.1	97.1	97.1	97.1	97.1	97.1	97.0	97.0	96.9	96.9	96.8	96.7	96.7
95	96.4	96.5	96.5	96.6	96.6	96.7	96.7	96.7	96.7	96.7	96.7	96.8	96.8	96.8	96.7	96.7	96.7	96.7	96.7	96.7
98	96.5	96.5	96.5	96.6	96.6	96.6	96.6	96.6	96.6	96.6	96.6	96.6	96.6	96.6	96.6	96.6	96.7	96.7	96.7	96.7

Mean Annual Mass Removal Efficiencies for 0.25-inches of Retention for Zone 3

NDCIA CN	Percent DCIA																			
	5	10	15	20	25	30	35	40	45	50	55	60	65	70	75	80	85	90	95	100
30	82.7	81.2	75.5	69.3	63.6	58.6	54.2	50.4	47.0	44.1	41.4	39.1	37.1	35.2	33.5	32.0	30.6	29.3	28.1	27.0
35	77.8	78.2	73.6	68.0	62.7	58.0	53.7	50.0	46.8	43.9	41.3	39.0	37.0	35.1	33.4	31.9	30.5	29.2	28.1	27.0
40	72.7	74.9	71.5	66.6	61.7	57.2	53.2	49.6	46.4	43.6	41.1	38.9	36.8	35.0	33.4	31.9	30.5	29.2	28.1	27.0
45	67.3	71.3	69.0	64.9	60.5	56.3	52.5	49.1	46.0	43.3	40.9	38.7	36.7	34.9	33.3	31.8	30.5	29.2	28.1	27.0
50	61.8	67.4	66.3	62.9	59.1	55.3	51.7	48.5	45.6	42.9	40.6	38.5	36.5	34.8	33.2	31.7	30.4	29.2	28.0	27.0
55	56.5	63.2	63.2	60.7	57.4	54.0	50.8	47.8	45.0	42.5	40.2	38.2	36.3	34.6	33.1	31.7	30.4	29.1	28.0	27.0
60	51.5	58.8	59.9	58.2	55.5	52.6	49.7	46.9	44.3	42.0	39.8	37.9	36.1	34.4	32.9	31.6	30.3	29.1	28.0	27.0
65	46.7	54.3	56.2	55.4	53.4	50.9	48.3	45.9	43.5	41.3	39.3	37.5	35.8	34.2	32.8	31.4	30.2	29.0	28.0	27.0
70	42.4	49.7	52.3	52.2	50.8	48.9	46.8	44.6	42.5	40.5	38.7	37.0	35.4	33.9	32.5	31.3	30.1	29.0	28.0	27.0
75	38.8	45.1	48.0	48.6	47.9	46.5	44.8	43.1	41.3	39.5	37.9	36.3	34.9	33.5	32.2	31.1	29.9	28.9	27.9	27.0
80	35.5	40.7	43.4	44.5	44.4	43.7	42.5	41.1	39.7	38.3	36.9	35.5	34.2	33.0	31.9	30.8	29.7	28.8	27.9	27.0
85	32.7	36.5	38.7	39.9	40.3	40.1	39.5	38.6	37.6	36.5	35.4	34.4	33.3	32.3	31.3	30.4	29.5	28.6	27.8	27.0
90	30.6	32.8	34.3	35.2	35.7	35.8	35.6	35.2	34.7	34.1	33.4	32.7	31.9	31.2	30.4	29.7	29.0	28.3	27.6	27.0
95	29.1	29.8	30.3	30.7	30.9	31.0	31.0	31.0	30.8	30.6	30.3	30.0	29.7	29.4	29.0	28.6	28.2	27.8	27.4	27.0
98	28.5	28.5	28.6	28.6	28.6	28.6	28.6	28.5	28.5	28.4	28.3	28.2	28.0	27.9	27.8	27.6	27.5	27.3	27.2	27.0

Mean Annual Mass Removal Efficiencies for 0.50-inches of Retention for Zone 3

NDCIA CN	Percent DCIA																			
	5	10	15	20	25	30	35	40	45	50	55	60	65	70	75	80	85	90	95	100
30	87.6	89.1	87.6	84.8	81.5	77.8	74.3	70.9	67.8	64.9	62.1	59.6	57.2	55.0	52.9	51.0	49.2	47.6	46.0	44.5
35	83.5	86.5	85.6	83.4	80.4	77.0	73.6	70.4	67.4	64.5	61.9	59.4	57.0	54.9	52.8	51.0	49.2	47.5	46.0	44.5
40	79.3	83.5	83.4	81.7	79.1	76.0	72.9	69.8	66.9	64.2	61.6	59.1	56.9	54.7	52.7	50.9	49.1	47.5	46.0	44.5
45	74.9	80.3	80.9	79.7	77.6	74.9	72.0	69.1	66.4	63.7	61.2	58.9	56.6	54.6	52.6	50.8	49.1	47.5	45.9	44.5
50	70.5	76.7	78.1	77.6	75.9	73.5	70.9	68.3	65.7	63.2	60.8	58.5	56.4	54.4	52.5	50.7	49.0	47.4	45.9	44.5
55	66.3	72.9	75.0	75.1	73.9	71.9	69.6	67.3	64.9	62.6	60.3	58.1	56.1	54.1	52.3	50.6	48.9	47.4	45.9	44.5
60	62.1	68.9	71.7	72.4	71.6	70.1	68.2	66.1	64.0	61.8	59.7	57.7	55.7	53.8	52.1	50.4	48.8	47.3	45.9	44.5
65	58.0	64.9	68.1	69.3	69.1	68.0	66.5	64.7	62.8	60.9	59.0	57.1	55.2	53.5	51.8	50.2	48.7	47.2	45.8	44.5
70	54.4	60.9	64.2	65.8	66.2	65.6	64.5	63.0	61.5	59.8	58.1	56.3	54.6	53.0	51.4	49.9	48.5	47.1	45.8	44.5
75	51.1	57.0	60.4	62.2	62.9	62.7	62.1	61.0	59.8	58.4	56.9	55.4	53.9	52.4	51.0	49.6	48.3	47.0	45.7	44.5
80	48.5	53.5	56.5	58.3	59.1	59.3	59.1	58.5	57.6	56.6	55.4	54.2	52.9	51.6	50.4	49.2	47.9	46.8	45.6	44.5
85	46.7	50.3	52.7	54.2	55.1	55.5	55.6	55.3	54.9	54.2	53.4	52.6	51.6	50.6	49.6	48.5	47.5	46.5	45.5	44.5
90	45.4	47.6	49.1	50.2	51.0	51.4	51.7	51.7	51.5	51.2	50.8	50.3	49.7	49.0	48.3	47.6	46.8	46.1	45.3	44.5
95	44.8	45.6	46.2	46.7	47.1	47.3	47.5	47.6	47.6	47.5	47.4	47.2	47.0	46.7	46.4	46.1	45.7	45.3	44.9	44.5
98	45.2	45.3	45.4	45.4	45.5	45.5	45.5	45.6	45.5	45.5	45.5	45.4	45.3	45.3	45.2	45.0	44.9	44.8	44.7	44.5

Mean Annual Mass Removal Efficiencies for 0.75-inches of Retention for Zone 3

NDCIA CN	Percent DCIA																			
	5	10	15	20	25	30	35	40	45	50	55	60	65	70	75	80	85	90	95	100
30	89.7	92.3	91.6	90.3	88.4	86.2	83.8	81.3	78.7	76.2	73.8	71.5	69.3	67.3	65.3	63.4	61.6	59.9	58.3	56.7
35	86.6	89.8	89.8	88.9	87.2	85.3	83.1	80.7	78.2	75.8	73.5	71.3	69.2	67.1	65.2	63.3	61.6	59.9	58.3	56.7
40	82.9	87.1	87.9	87.3	85.9	84.2	82.2	80.0	77.7	75.4	73.2	71.0	69.0	67.0	65.1	63.2	61.5	59.8	58.2	56.7
45	79.3	84.4	85.7	85.5	84.5	83.0	81.2	79.2	77.1	74.9	72.8	70.7	68.7	66.8	64.9	63.1	61.4	59.8	58.2	56.7
50	75.8	81.4	83.2	83.5	82.8	81.6	80.1	78.3	76.3	74.3	72.3	70.3	68.4	66.5	64.7	63.0	61.3	59.7	58.2	56.7
55	72.2	78.3	80.5	81.2	80.9	80.1	78.8	77.2	75.4	73.5	71.7	69.8	68.0	66.2	64.5	62.8	61.2	59.7	58.2	56.7
60	69.0	75.0	77.6	78.6	78.7	78.3	77.3	75.9	74.3	72.7	71.0	69.2	67.5	65.9	64.2	62.6	61.1	59.6	58.1	56.7
65	65.7	71.6	74.4	75.8	76.3	76.2	75.5	74.4	73.1	71.7	70.1	68.6	67.0	65.4	63.9	62.4	60.9	59.5	58.1	56.7
70	62.5	68.2	71.2	72.8	73.6	73.8	73.4	72.7	71.6	70.4	69.1	67.7	66.3	64.9	63.5	62.1	60.7	59.3	58.0	56.7
75	59.8	64.9	67.9	69.7	70.6	71.1	71.0	70.6	69.8	68.9	67.8	66.7	65.5	64.2	62.9	61.7	60.4	59.2	57.9	56.7
80	57.5	61.8	64.6	66.4	67.5	68.1	68.2	68.0	67.6	67.0	66.2	65.3	64.3	63.3	62.2	61.2	60.0	58.9	57.8	56.7
85	56.0	59.3	61.6	63.1	64.2	64.8	65.1	65.1	64.9	64.6	64.1	63.5	62.8	62.1	61.3	60.4	59.5	58.6	57.7	56.7
90	55.4	57.4	58.9	60.0	60.8	61.3	61.7	61.9	61.9	61.8	61.6	61.3	60.9	60.5	59.9	59.4	58.8	58.1	57.4	56.7
95	55.5	56.2	56.8	57.3	57.7	58.1	58.3	58.5	58.6	58.7	58.7	58.6	58.5	58.4	58.2	57.9	57.7	57.4	57.1	56.7
98	56.5	56.6	56.8	56.9	57.0	57.1	57.1	57.2	57.2	57.2	57.2	57.2	57.2	57.2	57.1	57.1	57.0	56.9	56.8	56.7

Mean Annual Mass Removal Efficiencies for 1.00-inches of Retention for Zone 3

NDCIA CN	Percent DCIA																			
	5	10	15	20	25	30	35	40	45	50	55	60	65	70	75	80	85	90	95	100
30	91.1	93.7	94.0	92.9	91.7	90.3	88.6	86.8	85.0	83.1	81.1	79.1	77.2	75.3	73.5	71.8	70.1	68.5	67.0	65.5
35	88.6	91.8	92.2	91.6	90.7	89.5	87.9	86.3	84.5	82.7	80.8	78.9	77.0	75.2	73.4	71.7	70.1	68.5	67.0	65.5
40	85.9	89.4	90.4	90.3	89.6	88.5	87.1	85.6	83.9	82.2	80.4	78.6	76.8	75.0	73.3	71.6	70.0	68.5	66.9	65.5
45	82.5	86.9	88.5	88.7	88.2	87.3	86.1	84.8	83.3	81.7	80.0	78.2	76.5	74.8	73.1	71.5	69.9	68.4	66.9	65.5
50	79.4	84.4	86.4	86.9	86.7	86.0	85.0	83.9	82.5	81.0	79.4	77.8	76.1	74.5	72.9	71.3	69.8	68.3	66.9	65.5
55	76.6	81.9	84.0	84.9	85.0	84.5	83.7	82.8	81.6	80.3	78.8	77.3	75.7	74.2	72.7	71.2	69.7	68.3	66.9	65.5
60	73.8	79.1	81.6	82.7	83.0	82.8	82.3	81.6	80.6	79.4	78.1	76.7	75.2	73.8	72.4	70.9	69.5	68.2	66.8	65.5
65	71.1	76.4	78.9	80.3	80.8	80.9	80.6	80.1	79.4	78.4	77.2	75.9	74.6	73.3	72.0	70.7	69.4	68.0	66.8	65.5
70	68.6	73.5	76.2	77.6	78.4	78.8	78.7	78.5	77.9	77.1	76.2	75.1	73.9	72.8	71.5	70.3	69.1	67.9	66.7	65.5
75	66.3	70.6	73.3	74.9	75.9	76.4	76.6	76.5	76.1	75.6	74.9	74.0	73.0	72.0	71.0	69.9	68.8	67.7	66.6	65.5
80	64.3	68.0	70.5	72.1	73.2	73.9	74.2	74.3	74.1	73.8	73.3	72.6	71.9	71.1	70.2	69.3	68.4	67.5	66.5	65.5
85	63.1	65.9	67.9	69.4	70.4	71.2	71.6	71.8	71.8	71.6	71.3	70.9	70.5	69.9	69.3	68.6	67.9	67.1	66.3	65.5
90	62.7	64.5	65.9	67.0	67.8	68.4	68.8	69.1	69.2	69.2	69.1	68.9	68.7	68.4	68.0	67.6	67.1	66.6	66.1	65.5
95	63.3	64.0	64.6	65.1	65.5	65.8	66.1	66.3	66.4	66.5	66.6	66.6	66.6	66.5	66.4	66.3	66.1	66.0	65.7	65.5
98	64.7	64.8	65.0	65.1	65.2	65.3	65.4	65.5	65.5	65.6	65.6	65.6	65.6	65.7	65.7	65.6	65.6	65.6	65.5	65.5

Mean Annual Mass Removal Efficiencies for 1.25-inches of Retention for Zone 3

NDCIA CN	Percent DCIA																			
	5	10	15	20	25	30	35	40	45	50	55	60	65	70	75	80	85	90	95	100
30	92.1	94.5	95.2	94.8	93.7	92.7	91.5	90.2	88.7	87.3	85.7	84.2	82.6	81.0	79.4	77.8	76.3	74.8	73.4	72.0
35	90.0	92.9	93.9	93.5	92.7	91.9	90.8	89.6	88.2	86.9	85.4	83.9	82.4	80.8	79.3	77.7	76.2	74.8	73.4	72.0
40	87.8	91.2	92.2	92.2	91.7	91.0	90.1	89.0	87.7	86.4	85.0	83.6	82.1	80.6	79.1	77.6	76.2	74.7	73.3	72.0
45	85.4	89.0	90.3	90.7	90.5	90.0	89.2	88.2	87.0	85.9	84.6	83.2	81.8	80.4	78.9	77.5	76.1	74.7	73.3	72.0
50	82.3	86.7	88.4	89.2	89.2	88.9	88.2	87.3	86.3	85.2	84.1	82.8	81.5	80.1	78.7	77.3	75.9	74.6	73.3	72.0
55	79.7	84.4	86.6	87.4	87.6	87.5	87.0	86.3	85.4	84.5	83.5	82.3	81.1	79.8	78.4	77.1	75.8	74.5	73.2	72.0
60	77.4	82.3	84.4	85.5	85.9	86.0	85.7	85.1	84.4	83.7	82.8	81.7	80.6	79.4	78.1	76.9	75.6	74.4	73.2	72.0
65	75.3	79.8	82.2	83.4	84.1	84.2	84.1	83.8	83.3	82.7	81.9	81.0	80.0	78.9	77.8	76.6	75.4	74.3	73.1	72.0
70	73.1	77.5	79.9	81.3	82.0	82.3	82.4	82.3	82.0	81.5	80.9	80.1	79.3	78.3	77.3	76.3	75.2	74.1	73.1	72.0
75	71.2	75.1	77.4	78.9	79.7	80.3	80.5	80.6	80.4	80.1	79.7	79.1	78.4	77.6	76.7	75.8	74.9	73.9	73.0	72.0
80	69.6	72.8	75.0	76.4	77.4	78.1	78.5	78.7	78.7	78.5	78.2	77.8	77.3	76.7	76.0	75.2	74.5	73.7	72.8	72.0
85	68.5	71.0	72.9	74.2	75.1	75.8	76.3	76.6	76.7	76.7	76.6	76.3	76.0	75.5	75.1	74.5	73.9	73.3	72.7	72.0
90	68.4	69.9	71.2	72.2	73.0	73.6	74.0	74.3	74.5	74.6	74.6	74.6	74.4	74.2	73.9	73.6	73.3	72.9	72.4	72.0
95	69.3	70.0	70.5	71.0	71.4	71.7	72.0	72.2	72.4	72.5	72.6	72.6	72.6	72.6	72.6	72.5	72.4	72.3	72.2	72.0
98	70.9	71.0	71.2	71.3	71.4	71.5	71.6	71.7	71.8	71.8	71.9	71.9	72.0	72.0	72.0	72.0	72.0	72.0	72.0	72.0

Mean Annual Mass Removal Efficiencies for 1.50-inches of Retention for Zone 3

NDCIA CN	Percent DCIA																			
	5	10	15	20	25	30	35	40	45	50	55	60	65	70	75	80	85	90	95	100
30	92.8	95.2	95.9	95.9	95.3	94.3	93.3	92.3	91.2	90.1	88.8	87.6	86.3	84.9	83.6	82.3	80.9	79.6	78.2	77.0
35	91.0	93.8	94.7	94.9	94.3	93.5	92.7	91.8	90.8	89.7	88.5	87.3	86.0	84.8	83.5	82.2	80.8	79.5	78.2	77.0
40	89.1	92.3	93.5	93.6	93.3	92.7	92.0	91.2	90.3	89.2	88.1	87.0	85.8	84.6	83.3	82.0	80.8	79.5	78.2	77.0
45	87.2	90.7	91.9	92.2	92.1	91.8	91.2	90.5	89.7	88.7	87.7	86.6	85.5	84.3	83.1	81.9	80.7	79.4	78.2	77.0
50	85.1	88.6	90.1	90.7	90.9	90.7	90.4	89.7	89.0	88.1	87.1	86.2	85.1	84.0	82.9	81.7	80.5	79.3	78.1	77.0
55	82.4	86.5	88.3	89.2	89.6	89.6	89.3	88.8	88.2	87.4	86.6	85.7	84.7	83.7	82.7	81.5	80.4	79.2	78.1	77.0
60	80.2	84.5	86.6	87.7	88.1	88.2	88.1	87.7	87.2	86.6	85.9	85.1	84.3	83.3	82.4	81.3	80.2	79.1	78.0	77.0
65	78.4	82.6	84.7	85.9	86.5	86.7	86.7	86.5	86.1	85.6	85.1	84.4	83.7	82.9	82.0	81.0	80.0	79.0	78.0	77.0
70	76.7	80.6	82.7	84.0	84.7	85.1	85.2	85.1	84.9	84.6	84.1	83.6	83.0	82.3	81.5	80.7	79.8	78.8	77.9	77.0
75	75.1	78.5	80.7	82.0	82.8	83.3	83.5	83.6	83.5	83.3	83.1	82.7	82.2	81.6	81.0	80.3	79.5	78.6	77.8	77.0
80	73.8	76.7	78.6	79.9	80.7	81.3	81.7	81.9	82.0	82.0	81.8	81.6	81.2	80.8	80.3	79.7	79.1	78.4	77.7	77.0
85	72.9	75.1	76.7	77.9	78.8	79.4	79.9	80.2	80.3	80.4	80.4	80.3	80.1	79.8	79.5	79.0	78.6	78.1	77.5	77.0
90	72.9	74.3	75.4	76.3	77.0	77.6	78.0	78.4	78.6	78.7	78.8	78.8	78.8	78.6	78.5	78.2	78.0	77.7	77.3	77.0
95	74.0	74.6	75.1	75.5	75.9	76.2	76.5	76.8	77.0	77.1	77.2	77.3	77.3	77.3	77.3	77.3	77.2	77.2	77.1	77.0
98	75.8	75.9	76.0	76.2	76.3	76.4	76.4	76.5	76.6	76.7	76.7	76.8	76.8	76.9	76.9	76.9	76.9	76.9	77.0	77.0

Mean Annual Mass Removal Efficiencies for 1.75-inches of Retention for Zone 3

NDCIA CN	Percent DCIA																			
	5	10	15	20	25	30	35	40	45	50	55	60	65	70	75	80	85	90	95	100
30	93.3	95.6	96.4	96.6	96.3	95.6	94.7	93.8	92.9	92.0	91.0	89.9	88.8	87.8	86.6	85.5	84.3	83.2	82.0	80.8
35	91.8	94.4	95.4	95.7	95.5	94.8	94.1	93.3	92.5	91.6	90.7	89.7	88.6	87.6	86.5	85.4	84.3	83.1	82.0	80.8
40	90.2	93.1	94.3	94.7	94.5	94.0	93.4	92.7	92.0	91.2	90.4	89.4	88.4	87.4	86.3	85.3	84.2	83.1	82.0	80.8
45	88.6	91.8	93.1	93.5	93.4	93.1	92.6	92.1	91.5	90.8	89.9	89.0	88.1	87.1	86.2	85.1	84.1	83.0	81.9	80.8
50	86.9	90.3	91.6	92.1	92.2	92.1	91.8	91.4	90.9	90.2	89.5	88.6	87.7	86.9	85.9	85.0	84.0	82.9	81.9	80.8
55	84.9	88.3	89.9	90.6	91.0	91.1	90.9	90.6	90.2	89.6	88.9	88.1	87.4	86.6	85.7	84.8	83.8	82.9	81.9	80.8
60	82.7	86.4	88.2	89.2	89.7	89.9	89.9	89.7	89.3	88.8	88.2	87.6	86.9	86.2	85.4	84.6	83.7	82.8	81.8	80.8
65	80.9	84.6	86.7	87.7	88.4	88.6	88.7	88.6	88.3	87.9	87.5	86.9	86.4	85.7	85.0	84.3	83.5	82.6	81.8	80.8
70	79.6	83.0	85.0	86.2	86.8	87.2	87.4	87.4	87.2	87.0	86.6	86.2	85.7	85.2	84.6	84.0	83.2	82.5	81.7	80.8
75	78.3	81.4	83.2	84.4	85.2	85.7	85.9	86.0	86.0	85.8	85.6	85.3	85.0	84.6	84.1	83.5	82.9	82.3	81.6	80.8
80	77.2	79.8	81.5	82.7	83.5	84.0	84.3	84.5	84.6	84.6	84.5	84.4	84.1	83.8	83.5	83.1	82.6	82.0	81.5	80.8
85	76.6	78.5	79.9	80.9	81.7	82.2	82.7	83.0	83.2	83.3	83.3	83.3	83.2	83.0	82.8	82.5	82.1	81.7	81.3	80.8
90	76.4	77.7	78.7	79.5	80.2	80.7	81.1	81.4	81.7	81.9	82.0	82.1	82.1	82.0	81.9	81.8	81.6	81.4	81.1	80.8
95	77.6	78.1	78.6	79.0	79.4	79.7	80.0	80.3	80.5	80.6	80.8	80.9	80.9	81.0	81.0	81.0	81.0	81.0	80.9	80.8
98	79.5	79.7	79.8	79.9	80.0	80.1	80.2	80.3	80.4	80.5	80.5	80.6	80.6	80.7	80.7	80.8	80.8	80.8	80.8	80.8

Mean Annual Mass Removal Efficiencies for 2.00-inches of Retention for Zone 3

NDCIA CN	Percent DCIA																			
	5	10	15	20	25	30	35	40	45	50	55	60	65	70	75	80	85	90	95	100
30	93.8	95.9	96.7	97.0	97.0	96.6	95.8	95.0	94.2	93.4	92.6	91.7	90.8	89.8	88.9	87.9	86.9	85.9	84.9	83.9
35	92.4	94.9	95.8	96.2	96.3	95.9	95.2	94.5	93.8	93.1	92.3	91.5	90.6	89.7	88.7	87.8	86.8	85.9	84.9	83.9
40	91.0	93.8	94.9	95.4	95.4	95.1	94.5	93.9	93.3	92.7	92.0	91.2	90.4	89.5	88.6	87.7	86.8	85.8	84.8	83.9
45	89.7	92.7	93.9	94.5	94.4	94.2	93.8	93.3	92.8	92.3	91.6	90.9	90.1	89.2	88.4	87.6	86.7	85.8	84.8	83.9
50	88.2	91.4	92.8	93.3	93.3	93.3	93.0	92.7	92.3	91.8	91.2	90.5	89.8	89.0	88.2	87.4	86.6	85.7	84.8	83.9
55	86.9	90.0	91.3	91.9	92.2	92.2	92.2	91.9	91.6	91.2	90.7	90.1	89.4	88.7	87.9	87.2	86.4	85.6	84.7	83.9
60	85.0	88.2	89.7	90.6	91.0	91.2	91.2	91.1	90.9	90.5	90.1	89.6	88.9	88.3	87.7	87.0	86.3	85.5	84.7	83.9
65	83.2	86.4	88.2	89.2	89.8	90.1	90.2	90.2	90.0	89.7	89.4	88.9	88.4	87.9	87.3	86.7	86.1	85.4	84.6	83.9
70	81.7	85.0	86.7	87.8	88.5	88.9	89.1	89.1	89.1	88.8	88.6	88.2	87.8	87.4	86.9	86.4	85.8	85.2	84.6	83.9
75	80.8	83.5	85.3	86.4	87.1	87.6	87.9	88.0	87.9	87.9	87.7	87.4	87.1	86.8	86.4	86.0	85.6	85.0	84.5	83.9
80	80.0	82.3	83.8	84.9	85.6	86.2	86.5	86.6	86.7	86.8	86.7	86.6	86.4	86.2	85.9	85.6	85.2	84.8	84.4	83.9
85	79.5	81.2	82.5	83.4	84.1	84.6	85.0	85.3	85.5	85.6	85.6	85.6	85.5	85.4	85.3	85.1	84.9	84.6	84.2	83.9
90	79.5	80.6	81.5	82.2	82.8	83.3	83.6	83.9	84.2	84.3	84.5	84.6	84.6	84.6	84.6	84.5	84.4	84.3	84.1	83.9
95	80.6	81.1	81.5	81.9	82.2	82.5	82.8	83.0	83.2	83.4	83.5	83.6	83.7	83.8	83.9	83.9	83.9	83.9	83.9	83.9
98	82.4	82.6	82.7	82.8	82.9	83.1	83.2	83.2	83.3	83.4	83.5	83.5	83.6	83.7	83.7	83.7	83.8	83.8	83.9	83.9

Mean Annual Mass Removal Efficiencies for 2.25-inches of Retention for Zone 3

NDCIA CN	Percent DCIA																			
	5	10	15	20	25	30	35	40	45	50	55	60	65	70	75	80	85	90	95	100
30	94.1	96.2	97.0	97.3	97.4	97.2	96.7	96.0	95.2	94.5	93.8	93.0	92.3	91.5	90.6	89.8	88.9	88.0	87.1	86.2
35	92.9	95.3	96.2	96.6	96.8	96.6	96.1	95.5	94.8	94.2	93.5	92.8	92.1	91.3	90.5	89.7	88.8	88.0	87.1	86.2
40	91.7	94.3	95.4	95.9	96.1	95.9	95.5	95.0	94.4	93.8	93.2	92.5	91.9	91.1	90.4	89.5	88.7	87.9	87.1	86.2
45	90.6	93.3	94.6	95.1	95.3	95.1	94.8	94.4	93.9	93.4	92.8	92.2	91.6	90.9	90.2	89.4	88.6	87.9	87.1	86.2
50	89.4	92.3	93.6	94.2	94.3	94.2	94.0	93.7	93.3	92.9	92.5	91.9	91.3	90.7	90.0	89.3	88.5	87.8	87.0	86.2
55	88.2	91.2	92.5	93.1	93.3	93.3	93.2	93.0	92.7	92.4	92.0	91.5	91.0	90.4	89.7	89.1	88.4	87.7	87.0	86.2
60	87.0	89.7	91.1	91.8	92.1	92.3	92.3	92.2	92.0	91.8	91.5	91.0	90.6	90.1	89.5	88.9	88.2	87.6	86.9	86.2
65	85.3	88.1	89.6	90.5	91.0	91.3	91.4	91.4	91.3	91.1	90.9	90.5	90.1	89.7	89.1	88.6	88.1	87.5	86.9	86.2
70	83.8	86.6	88.2	89.2	89.8	90.2	90.4	90.5	90.5	90.4	90.2	89.9	89.6	89.2	88.8	88.3	87.9	87.4	86.8	86.2
75	82.9	85.3	86.9	87.9	88.6	89.1	89.3	89.5	89.6	89.5	89.4	89.2	89.0	88.7	88.3	88.0	87.6	87.2	86.7	86.2
80	82.2	84.3	85.7	86.7	87.4	87.9	88.2	88.4	88.5	88.5	88.5	88.4	88.3	88.1	87.8	87.6	87.3	87.0	86.6	86.2
85	81.9	83.4	84.6	85.5	86.1	86.6	86.9	87.2	87.4	87.5	87.5	87.5	87.5	87.4	87.3	87.1	87.0	86.8	86.5	86.2
90	82.1	83.0	83.8	84.5	85.0	85.4	85.7	86.0	86.2	86.4	86.5	86.6	86.7	86.7	86.7	86.7	86.6	86.5	86.4	86.2
95	83.0	83.5	83.9	84.2	84.5	84.8	85.0	85.2	85.4	85.6	85.7	85.8	85.9	86.0	86.1	86.2	86.2	86.2	86.3	86.2
98	84.8	84.9	85.0	85.1	85.3	85.4	85.5	85.6	85.6	85.7	85.8	85.9	85.9	86.0	86.0	86.1	86.1	86.2	86.2	86.2

Mean Annual Mass Removal Efficiencies for 2.50-inches of Retention for Zone 3

NDCIA CN	Percent DCIA																			
	5	10	15	20	25	30	35	40	45	50	55	60	65	70	75	80	85	90	95	100
30	94.3	96.4	97.2	97.5	97.6	97.6	97.3	96.8	96.1	95.4	94.7	94.1	93.4	92.7	92.0	91.3	90.5	89.7	88.9	88.1
35	93.3	95.6	96.5	96.9	97.1	97.1	96.8	96.3	95.7	95.1	94.5	93.9	93.2	92.6	91.9	91.2	90.4	89.7	88.9	88.1
40	92.3	94.7	95.8	96.3	96.5	96.5	96.3	95.8	95.3	94.7	94.2	93.6	93.0	92.4	91.7	91.1	90.3	89.6	88.9	88.1
45	91.2	93.9	95.0	95.6	95.9	95.9	95.6	95.2	94.8	94.3	93.8	93.3	92.8	92.2	91.6	90.9	90.2	89.5	88.8	88.1
50	90.3	93.0	94.2	94.9	95.1	95.1	94.9	94.6	94.3	93.8	93.4	93.0	92.5	92.0	91.4	90.8	90.1	89.5	88.8	88.1
55	89.3	92.1	93.4	94.0	94.2	94.2	94.1	93.9	93.7	93.3	93.0	92.6	92.2	91.7	91.2	90.6	90.0	89.4	88.8	88.1
60	88.4	91.0	92.2	92.9	93.1	93.3	93.3	93.2	93.0	92.8	92.5	92.2	91.8	91.4	90.9	90.4	89.9	89.3	88.7	88.1
65	87.2	89.6	90.9	91.6	92.1	92.3	92.4	92.4	92.3	92.2	92.0	91.7	91.4	91.0	90.7	90.2	89.7	89.2	88.7	88.1
70	85.8	88.2	89.5	90.5	91.0	91.3	91.5	91.6	91.6	91.5	91.4	91.2	90.9	90.6	90.3	89.9	89.5	89.0	88.6	88.1
75	84.7	87.0	88.3	89.2	89.9	90.3	90.6	90.7	90.8	90.8	90.7	90.6	90.4	90.2	89.9	89.6	89.2	88.9	88.5	88.1
80	84.0	85.9	87.2	88.1	88.8	89.2	89.6	89.8	89.9	90.0	90.0	89.9	89.8	89.7	89.5	89.2	89.0	88.7	88.4	88.1
85	83.8	85.3	86.3	87.1	87.7	88.2	88.5	88.8	89.0	89.1	89.1	89.1	89.1	89.1	89.0	88.8	88.7	88.5	88.3	88.1
90	84.1	85.0	85.8	86.4	86.8	87.2	87.5	87.8	88.0	88.1	88.3	88.3	88.4	88.4	88.4	88.4	88.3	88.3	88.2	88.1
95	85.1	85.5	85.9	86.2	86.5	86.7	86.9	87.1	87.3	87.4	87.5	87.7	87.8	87.8	87.9	88.0	88.0	88.1	88.1	88.1
98	86.7	86.8	86.9	87.0	87.1	87.2	87.3	87.4	87.5	87.6	87.6	87.7	87.8	87.8	87.9	88.0	88.0	88.0	88.1	88.1

Mean Annual Mass Removal Efficiencies for 2.75-inches of Retention for Zone 3

NDCIA CN	Percent DCIA																			
	5	10	15	20	25	30	35	40	45	50	55	60	65	70	75	80	85	90	95	100
30	94.6	96.5	97.3	97.7	97.8	97.9	97.7	97.4	96.8	96.2	95.6	94.9	94.4	93.7	93.1	92.4	91.8	91.1	90.4	89.6
35	93.6	95.9	96.7	97.1	97.3	97.4	97.3	97.0	96.5	95.9	95.3	94.7	94.2	93.6	93.0	92.4	91.7	91.0	90.3	89.6
40	92.8	95.1	96.1	96.6	96.8	97.0	96.8	96.5	96.0	95.5	95.0	94.5	94.0	93.4	92.8	92.2	91.6	91.0	90.3	89.6
45	91.8	94.3	95.4	96.0	96.3	96.4	96.3	96.0	95.6	95.1	94.7	94.2	93.7	93.2	92.7	92.1	91.6	90.9	90.3	89.6
50	91.0	93.6	94.8	95.4	95.7	95.8	95.6	95.4	95.0	94.7	94.3	93.9	93.5	93.0	92.5	92.0	91.5	90.9	90.3	89.6
55	90.2	92.8	94.0	94.7	95.0	95.0	94.9	94.7	94.5	94.2	93.9	93.5	93.2	92.8	92.3	91.8	91.3	90.8	90.2	89.6
60	89.4	92.0	93.2	93.8	94.0	94.1	94.2	94.0	93.9	93.7	93.4	93.1	92.9	92.5	92.1	91.7	91.2	90.7	90.2	89.6
65	88.7	90.9	92.0	92.7	93.1	93.3	93.3	93.3	93.2	93.1	92.9	92.7	92.5	92.2	91.8	91.4	91.1	90.6	90.1	89.6
70	87.5	89.6	90.8	91.6	92.1	92.3	92.5	92.5	92.5	92.5	92.4	92.2	92.0	91.8	91.5	91.2	90.9	90.5	90.1	89.6
75	86.4	88.4	89.7	90.4	91.0	91.3	91.6	91.7	91.8	91.8	91.8	91.7	91.6	91.4	91.2	90.9	90.7	90.3	90.0	89.6
80	85.8	87.4	88.6	89.4	90.0	90.4	90.7	90.9	91.0	91.1	91.1	91.1	91.0	90.9	90.8	90.6	90.4	90.2	89.9	89.6
85	85.5	86.8	87.7	88.5	89.0	89.4	89.8	90.0	90.2	90.3	90.4	90.4	90.4	90.4	90.4	90.3	90.1	90.0	89.8	89.6
90	85.8	86.6	87.3	87.9	88.3	88.7	89.0	89.2	89.4	89.6	89.7	89.8	89.8	89.9	89.9	89.9	89.8	89.8	89.7	89.6
95	86.9	87.2	87.6	87.8	88.1	88.3	88.5	88.7	88.9	89.0	89.1	89.2	89.3	89.4	89.5	89.5	89.5	89.6	89.6	89.6
98	88.4	88.5	88.6	88.7	88.8	88.9	88.9	89.0	89.1	89.1	89.2	89.3	89.3	89.4	89.4	89.5	89.5	89.6	89.6	89.6

Mean Annual Mass Removal Efficiencies for 3.00-inches of Retention for Zone 3

NDCIA CN	Percent DCIA																			
	5	10	15	20	25	30	35	40	45	50	55	60	65	70	75	80	85	90	95	100
30	94.9	96.7	97.4	97.8	98.0	98.0	98.0	97.8	97.4	96.9	96.3	95.7	95.1	94.6	94.0	93.4	92.8	92.2	91.6	90.9
35	93.9	96.0	96.9	97.3	97.5	97.6	97.7	97.4	97.1	96.6	96.0	95.5	94.9	94.4	93.9	93.3	92.7	92.2	91.6	90.9
40	93.1	95.4	96.3	96.8	97.1	97.2	97.2	97.1	96.7	96.2	95.7	95.2	94.7	94.3	93.7	93.2	92.7	92.1	91.5	90.9
45	92.4	94.7	95.7	96.3	96.6	96.8	96.8	96.6	96.2	95.8	95.4	95.0	94.5	94.1	93.6	93.1	92.6	92.1	91.5	90.9
50	91.6	94.0	95.2	95.8	96.1	96.3	96.2	96.0	95.8	95.4	95.1	94.7	94.3	93.9	93.4	93.0	92.5	92.0	91.5	90.9
55	91.0	93.4	94.6	95.2	95.6	95.7	95.6	95.4	95.2	94.9	94.6	94.3	94.0	93.6	93.3	92.8	92.4	91.9	91.4	90.9
60	90.4	92.7	93.9	94.6	94.8	94.9	94.9	94.8	94.6	94.4	94.2	93.9	93.7	93.4	93.0	92.7	92.3	91.9	91.4	90.9
65	89.8	92.0	93.0	93.6	93.9	94.1	94.2	94.1	94.0	93.9	93.7	93.5	93.3	93.1	92.8	92.5	92.1	91.8	91.4	90.9
70	89.0	90.9	91.9	92.6	93.0	93.2	93.3	93.4	93.4	93.3	93.2	93.1	92.9	92.8	92.5	92.2	92.0	91.6	91.3	90.9
75	88.0	89.7	90.8	91.6	92.0	92.3	92.5	92.6	92.7	92.7	92.7	92.6	92.5	92.4	92.2	92.0	91.8	91.5	91.2	90.9
80	87.3	88.8	89.8	90.5	91.0	91.4	91.7	91.8	92.0	92.0	92.1	92.1	92.1	92.0	91.8	91.7	91.6	91.4	91.2	90.9
85	87.0	88.1	89.0	89.7	90.1	90.5	90.8	91.1	91.3	91.4	91.5	91.5	91.5	91.5	91.5	91.4	91.3	91.2	91.1	90.9
90	87.2	88.0	88.6	89.1	89.5	89.9	90.2	90.4	90.6	90.7	90.8	90.9	91.0	91.0	91.1	91.1	91.1	91.0	91.0	90.9
95	88.3	88.7	88.9	89.2	89.4	89.6	89.8	90.0	90.1	90.2	90.4	90.5	90.6	90.7	90.7	90.8	90.8	90.9	90.9	90.9
98	89.7	89.8	89.9	90.0	90.1	90.2	90.3	90.3	90.4	90.5	90.5	90.6	90.6	90.7	90.7	90.8	90.8	90.9	90.9	90.9

Mean Annual Mass Removal Efficiencies for 3.25-inches of Retention for Zone 3

NDCIA CN	Percent DCIA																			
	5	10	15	20	25	30	35	40	45	50	55	60	65	70	75	80	85	90	95	100
30	95.2	96.9	97.5	97.9	98.1	98.2	98.2	98.1	97.8	97.5	96.9	96.4	95.8	95.3	94.7	94.2	93.7	93.1	92.6	92.0
35	94.1	96.2	97.0	97.5	97.7	97.8	97.9	97.8	97.5	97.2	96.7	96.2	95.6	95.1	94.6	94.1	93.6	93.1	92.5	92.0
40	93.4	95.6	96.6	97.0	97.3	97.5	97.5	97.4	97.2	96.8	96.4	95.9	95.4	95.0	94.5	94.0	93.5	93.0	92.5	92.0
45	92.8	95.0	96.0	96.6	96.9	97.1	97.1	97.1	96.8	96.5	96.1	95.7	95.2	94.8	94.4	93.9	93.5	93.0	92.5	92.0
50	92.1	94.4	95.5	96.1	96.5	96.7	96.7	96.6	96.3	96.1	95.7	95.4	95.0	94.6	94.2	93.8	93.4	92.9	92.5	92.0
55	91.5	93.8	95.0	95.6	96.0	96.2	96.2	96.0	95.9	95.6	95.3	95.0	94.7	94.4	94.0	93.7	93.3	92.9	92.4	92.0
60	91.1	93.3	94.4	95.1	95.5	95.6	95.5	95.5	95.3	95.1	94.9	94.7	94.4	94.1	93.8	93.5	93.2	92.8	92.4	92.0
65	90.7	92.7	93.8	94.4	94.7	94.8	94.9	94.9	94.8	94.6	94.5	94.3	94.0	93.8	93.6	93.3	93.0	92.7	92.4	92.0
70	90.3	92.0	92.9	93.4	93.8	94.0	94.2	94.2	94.1	94.1	94.0	93.8	93.7	93.5	93.4	93.1	92.9	92.6	92.3	92.0
75	89.4	90.9	91.8	92.5	93.0	93.2	93.4	93.5	93.5	93.5	93.4	93.4	93.3	93.2	93.1	92.9	92.7	92.5	92.2	92.0
80	88.7	90.1	91.0	91.6	92.0	92.3	92.6	92.7	92.8	92.9	92.9	92.9	92.9	92.9	92.8	92.6	92.5	92.3	92.2	92.0
85	88.4	89.4	90.2	90.7	91.2	91.5	91.8	92.0	92.1	92.3	92.4	92.4	92.5	92.5	92.4	92.4	92.3	92.2	92.1	92.0
90	88.5	89.2	89.7	90.2	90.6	90.9	91.2	91.4	91.6	91.7	91.9	91.9	92.0	92.0	92.0	92.1	92.1	92.1	92.0	92.0
95	89.6	89.9	90.1	90.4	90.6	90.8	90.9	91.1	91.2	91.3	91.4	91.5	91.6	91.7	91.8	91.8	91.9	91.9	92.0	92.0
98	90.8	90.9	91.0	91.1	91.2	91.2	91.3	91.4	91.4	91.5	91.6	91.6	91.7	91.7	91.8	91.8	91.9	91.9	92.0	92.0

Mean Annual Mass Removal Efficiencies for 3.50-inches of Retention for Zone 3

NDCIA CN	Percent DCIA																			
	5	10	15	20	25	30	35	40	45	50	55	60	65	70	75	80	85	90	95	100
30	95.5	97.0	97.6	98.0	98.2	98.3	98.3	98.3	98.1	97.9	97.5	96.9	96.4	95.9	95.4	94.9	94.4	93.9	93.4	92.9
35	94.4	96.3	97.2	97.6	97.9	98.0	98.0	98.0	97.9	97.6	97.2	96.7	96.3	95.8	95.3	94.8	94.4	93.9	93.4	92.9
40	93.6	95.8	96.8	97.2	97.5	97.6	97.7	97.7	97.6	97.3	96.9	96.5	96.1	95.6	95.2	94.7	94.3	93.8	93.4	92.9
45	93.2	95.3	96.3	96.8	97.1	97.3	97.4	97.4	97.3	97.0	96.6	96.3	95.9	95.4	95.0	94.6	94.2	93.8	93.3	92.9
50	92.6	94.7	95.8	96.4	96.7	97.0	97.1	97.0	96.9	96.6	96.3	96.0	95.6	95.2	94.9	94.5	94.1	93.7	93.3	92.9
55	92.1	94.2	95.3	96.0	96.4	96.6	96.7	96.6	96.4	96.2	95.9	95.6	95.3	95.0	94.7	94.4	94.0	93.7	93.3	92.9
60	91.7	93.8	94.9	95.5	95.9	96.1	96.1	96.0	95.9	95.8	95.5	95.3	95.0	94.8	94.5	94.2	93.9	93.6	93.2	92.9
65	91.4	93.3	94.4	95.0	95.4	95.5	95.5	95.5	95.4	95.3	95.1	94.9	94.7	94.5	94.3	94.0	93.8	93.5	93.2	92.9
70	91.2	92.9	93.8	94.3	94.5	94.7	94.8	94.9	94.8	94.8	94.7	94.5	94.4	94.2	94.0	93.9	93.7	93.4	93.1	92.9
75	90.7	92.0	92.8	93.3	93.7	94.0	94.1	94.2	94.2	94.2	94.2	94.1	94.0	93.9	93.8	93.7	93.5	93.3	93.1	92.9
80	89.9	91.1	91.9	92.5	92.9	93.2	93.4	93.5	93.6	93.6	93.7	93.6	93.6	93.6	93.5	93.4	93.3	93.2	93.0	92.9
85	89.7	90.5	91.2	91.7	92.1	92.4	92.7	92.8	93.0	93.0	93.1	93.2	93.2	93.2	93.2	93.2	93.1	93.1	93.0	92.9
90	89.7	90.3	90.8	91.2	91.5	91.8	92.0	92.2	92.4	92.5	92.7	92.8	92.8	92.9	92.9	92.9	92.9	92.9	92.9	92.9
95	90.6	90.9	91.1	91.3	91.5	91.7	91.9	92.0	92.2	92.3	92.4	92.4	92.5	92.6	92.7	92.7	92.8	92.8	92.8	92.9
98	91.8	91.9	92.0	92.0	92.1	92.2	92.2	92.3	92.4	92.4	92.5	92.5	92.6	92.6	92.7	92.7	92.8	92.8	92.8	92.9

Mean Annual Mass Removal Efficiencies for 3.75-inches of Retention for Zone 3

NDCIA CN	Percent DCIA																			
	5	10	15	20	25	30	35	40	45	50	55	60	65	70	75	80	85	90	95	100
30	95.8	97.2	97.8	98.1	98.2	98.4	98.4	98.3	98.3	98.2	97.9	97.5	97.0	96.5	96.0	95.5	95.0	94.6	94.1	93.6
35	94.7	96.5	97.3	97.7	98.0	98.1	98.2	98.1	98.1	97.9	97.7	97.3	96.8	96.3	95.9	95.4	95.0	94.5	94.1	93.6
40	93.9	95.9	96.9	97.4	97.7	97.8	97.9	97.9	97.9	97.7	97.4	97.0	96.6	96.2	95.8	95.3	94.9	94.5	94.1	93.6
45	93.4	95.5	96.5	97.0	97.3	97.5	97.6	97.7	97.6	97.4	97.1	96.8	96.4	96.0	95.6	95.2	94.8	94.5	94.1	93.6
50	93.1	95.1	96.0	96.6	97.0	97.2	97.3	97.4	97.3	97.1	96.8	96.5	96.2	95.8	95.5	95.1	94.8	94.4	94.0	93.6
55	92.5	94.6	95.6	96.2	96.6	96.9	97.0	97.0	96.9	96.7	96.5	96.2	95.9	95.6	95.3	95.0	94.7	94.3	94.0	93.6
60	92.2	94.1	95.2	95.9	96.3	96.5	96.6	96.6	96.4	96.3	96.1	95.9	95.6	95.4	95.1	94.8	94.6	94.3	94.0	93.6
65	92.0	93.8	94.8	95.5	95.9	96.1	96.1	96.0	96.0	95.9	95.7	95.5	95.3	95.1	94.9	94.7	94.4	94.2	93.9	93.6
70	91.9	93.5	94.4	95.0	95.3	95.4	95.4	95.5	95.5	95.4	95.3	95.2	95.0	94.8	94.7	94.5	94.3	94.1	93.9	93.6
75	91.8	93.0	93.7	94.1	94.4	94.7	94.8	94.9	94.9	94.9	94.8	94.7	94.7	94.5	94.4	94.3	94.2	94.0	93.8	93.6
80	91.1	92.1	92.8	93.3	93.7	94.0	94.1	94.2	94.3	94.3	94.3	94.3	94.3	94.2	94.2	94.1	94.0	93.9	93.8	93.6
85	90.7	91.6	92.2	92.6	93.0	93.2	93.4	93.6	93.7	93.8	93.8	93.9	93.9	93.9	93.9	93.9	93.8	93.8	93.7	93.6
90	90.8	91.3	91.8	92.1	92.4	92.7	92.9	93.0	93.2	93.3	93.4	93.5	93.5	93.6	93.6	93.7	93.7	93.7	93.7	93.6
95	91.5	91.7	92.0	92.2	92.3	92.5	92.7	92.8	92.9	93.0	93.1	93.2	93.3	93.4	93.4	93.5	93.5	93.6	93.6	93.6
98	92.6	92.7	92.8	92.9	92.9	93.0	93.1	93.1	93.2	93.2	93.3	93.3	93.4	93.4	93.4	93.5	93.5	93.6	93.6	93.6

Mean Annual Mass Removal Efficiencies for 4.00-inches of Retention for Zone 3

NDCIA CN	Percent DCIA																			
	5	10	15	20	25	30	35	40	45	50	55	60	65	70	75	80	85	90	95	100
30	96.1	97.4	97.9	98.1	98.3	98.4	98.5	98.5	98.5	98.4	98.2	97.9	97.4	97.0	96.5	96.1	95.6	95.2	94.7	94.3
35	95.0	96.7	97.4	97.8	98.0	98.2	98.3	98.3	98.3	98.2	98.0	97.7	97.3	96.9	96.4	96.0	95.5	95.1	94.7	94.3
40	94.1	96.1	97.0	97.5	97.8	97.9	98.0	98.1	98.1	98.0	97.8	97.5	97.1	96.7	96.3	95.9	95.5	95.1	94.7	94.3
45	93.6	95.7	96.7	97.2	97.5	97.7	97.8	97.8	97.8	97.7	97.5	97.3	96.9	96.5	96.2	95.8	95.4	95.0	94.7	94.3
50	93.3	95.4	96.3	96.8	97.1	97.4	97.5	97.6	97.6	97.5	97.3	97.0	96.7	96.4	96.0	95.7	95.3	95.0	94.6	94.3
55	93.0	94.9	95.9	96.4	96.8	97.1	97.3	97.3	97.3	97.1	96.9	96.7	96.4	96.1	95.9	95.5	95.2	94.9	94.6	94.3
60	92.7	94.5	95.5	96.1	96.5	96.8	97.0	97.0	96.9	96.8	96.6	96.4	96.2	95.9	95.7	95.4	95.1	94.9	94.6	94.3
65	92.4	94.2	95.2	95.8	96.2	96.5	96.6	96.6	96.5	96.4	96.2	96.1	95.9	95.7	95.5	95.2	95.0	94.8	94.6	94.3
70	92.5	94.0	94.9	95.5	95.8	96.0	96.0	96.0	96.0	95.9	95.8	95.7	95.6	95.4	95.2	95.1	94.9	94.7	94.5	94.3
75	92.5	93.7	94.5	94.9	95.1	95.3	95.4	95.5	95.5	95.5	95.4	95.3	95.3	95.1	95.0	94.9	94.8	94.6	94.5	94.3
80	92.2	93.1	93.7	94.1	94.4	94.6	94.8	94.9	94.9	95.0	95.0	94.9	94.9	94.8	94.8	94.7	94.6	94.5	94.4	94.3
85	91.7	92.5	93.0	93.4	93.7	94.0	94.1	94.3	94.4	94.5	94.5	94.5	94.5	94.5	94.5	94.5	94.5	94.4	94.4	94.3
90	91.7	92.2	92.6	92.9	93.2	93.4	93.6	93.7	93.9	94.0	94.0	94.1	94.2	94.2	94.3	94.3	94.3	94.3	94.3	94.3
95	92.4	92.6	92.8	92.9	93.1	93.2	93.4	93.5	93.6	93.7	93.8	93.9	93.9	94.0	94.1	94.1	94.2	94.2	94.3	94.3
98	93.3	93.4	93.5	93.6	93.6	93.7	93.8	93.8	93.8	93.9	93.9	94.0	94.0	94.1	94.1	94.2	94.2	94.2	94.3	94.3

Mean Annual Mass Removal Efficiencies for 0.25-inches of Retention for Zone 4

NDCIA CN	Percent DCIA																			
	5	10	15	20	25	30	35	40	45	50	55	60	65	70	75	80	85	90	95	100
30	90.1	86.6	79.2	71.4	64.5	58.6	53.5	49.2	45.5	42.3	39.5	37.1	34.9	33.0	31.3	29.7	28.3	27.1	25.9	24.8
35	86.2	84.3	77.8	70.5	63.9	58.2	53.2	49.0	45.3	42.2	39.4	37.0	34.9	33.0	31.2	29.7	28.3	27.0	25.9	24.8
40	81.6	81.5	75.9	69.3	63.1	57.6	52.8	48.7	45.1	42.0	39.3	36.9	34.8	32.9	31.2	29.7	28.3	27.0	25.9	24.8
45	76.5	78.1	73.7	67.8	62.0	56.8	52.2	48.2	44.8	41.8	39.1	36.8	34.7	32.8	31.1	29.6	28.3	27.0	25.9	24.8
50	71.0	74.2	71.0	65.9	60.7	55.8	51.5	47.7	44.4	41.4	38.9	36.6	34.5	32.7	31.1	29.6	28.2	27.0	25.9	24.8
55	65.3	69.9	67.9	63.7	59.1	54.7	50.6	47.0	43.8	41.1	38.5	36.3	34.4	32.6	31.0	29.5	28.2	27.0	25.8	24.8
60	59.7	65.2	64.4	61.2	57.2	53.2	49.6	46.2	43.2	40.6	38.2	36.1	34.1	32.4	30.8	29.4	28.1	26.9	25.8	24.8
65	54.2	60.2	60.5	58.2	55.0	51.5	48.2	45.2	42.4	39.9	37.7	35.7	33.8	32.2	30.7	29.3	28.0	26.9	25.8	24.8
70	49.1	54.9	56.1	54.7	52.3	49.4	46.6	43.9	41.4	39.2	37.1	35.2	33.5	31.9	30.5	29.1	27.9	26.8	25.8	24.8
75	44.3	49.4	51.1	50.7	49.1	46.9	44.6	42.3	40.1	38.1	36.3	34.6	33.0	31.5	30.2	28.9	27.8	26.7	25.7	24.8
80	40.0	44.1	45.8	46.0	45.2	43.7	42.0	40.2	38.5	36.8	35.2	33.7	32.3	31.0	29.8	28.7	27.6	26.6	25.7	24.8
85	36.2	38.9	40.4	40.8	40.6	39.8	38.8	37.5	36.3	35.0	33.7	32.5	31.4	30.2	29.2	28.2	27.3	26.4	25.6	24.8
90	32.8	34.2	35.0	35.4	35.4	35.1	34.6	33.9	33.2	32.4	31.6	30.8	29.9	29.1	28.3	27.6	26.9	26.1	25.5	24.8
95	29.3	29.7	29.9	30.0	29.9	29.8	29.7	29.4	29.1	28.8	28.5	28.1	27.7	27.3	26.9	26.5	26.1	25.6	25.2	24.8
98	27.2	27.2	27.2	27.1	27.0	27.0	26.8	26.7	26.6	26.5	26.3	26.2	26.0	25.9	25.7	25.5	25.4	25.2	25.0	24.8

Mean Annual Mass Removal Efficiencies for 0.50-inches of Retention for Zone 4

NDCIA CN	Percent DCIA																			
	5	10	15	20	25	30	35	40	45	50	55	60	65	70	75	80	85	90	95	100
30	94.0	94.2	92.1	88.8	84.8	80.5	76.3	72.4	68.6	65.2	62.0	59.1	56.4	53.9	51.7	49.5	47.6	45.8	44.1	42.6
35	91.1	92.3	90.7	87.7	84.0	79.9	75.9	72.0	68.4	65.0	61.9	59.0	56.3	53.9	51.6	49.5	47.6	45.8	44.1	42.6
40	87.8	90.0	88.9	86.4	82.9	79.1	75.3	71.5	68.0	64.7	61.6	58.8	56.2	53.8	51.5	49.4	47.5	45.7	44.1	42.6
45	84.0	87.2	86.8	84.7	81.6	78.1	74.5	70.9	67.5	64.3	61.3	58.6	56.0	53.6	51.4	49.4	47.5	45.7	44.1	42.6
50	79.9	84.0	84.3	82.7	80.1	76.9	73.5	70.2	66.9	63.9	61.0	58.3	55.8	53.5	51.3	49.3	47.4	45.7	44.1	42.6
55	75.6	80.4	81.4	80.4	78.2	75.4	72.3	69.2	66.2	63.3	60.5	57.9	55.5	53.2	51.1	49.2	47.3	45.6	44.0	42.6
60	71.3	76.5	78.1	77.6	75.9	73.6	70.9	68.0	65.2	62.5	59.9	57.4	55.1	53.0	50.9	49.0	47.2	45.6	44.0	42.6
65	67.1	72.4	74.4	74.5	73.3	71.4	69.1	66.6	64.1	61.6	59.2	56.9	54.7	52.6	50.6	48.8	47.1	45.5	44.0	42.6
70	63.0	68.1	70.3	70.8	70.2	68.9	67.0	64.9	62.7	60.5	58.3	56.1	54.1	52.1	50.3	48.6	46.9	45.4	43.9	42.6
75	59.2	63.7	65.9	66.7	66.6	65.7	64.4	62.7	60.9	59.0	57.1	55.2	53.3	51.5	49.8	48.2	46.7	45.2	43.8	42.6
80	55.8	59.4	61.4	62.3	62.4	61.9	61.1	59.9	58.6	57.1	55.5	53.9	52.3	50.7	49.2	47.8	46.4	45.0	43.6	42.6
85	52.7	55.2	56.7	57.5	57.7	57.6	57.1	56.4	55.5	54.5	53.3	52.1	50.8	49.6	48.3	47.1	45.9	44.7	43.6	42.6
90	49.7	51.1	52.0	52.5	52.8	52.8	52.6	52.2	51.7	51.1	50.3	49.6	48.7	47.9	47.0	46.1	45.2	44.3	43.4	42.6
95	46.7	47.1	47.4	47.5	47.6	47.6	47.5	47.3	47.1	46.8	46.5	46.2	45.8	45.4	44.9	44.5	44.0	43.5	43.0	42.6
98	44.9	44.9	44.8	44.8	44.7	44.7	44.6	44.5	44.3	44.2	44.1	44.0	43.8	43.6	43.5	43.3	43.1	42.9	42.7	42.6

Mean Annual Mass Removal Efficiencies for 0.75-inches of Retention for Zone 4

NDCIA CN	Percent DCIA																			
	5	10	15	20	25	30	35	40	45	50	55	60	65	70	75	80	85	90	95	100
30	95.6	96.4	95.6	94.1	92.1	89.6	86.8	83.9	81.0	78.1	75.3	72.7	70.1	67.7	65.4	63.3	61.2	59.3	57.4	55.7
35	93.5	94.9	94.5	93.2	91.3	89.0	86.3	83.5	80.7	77.9	75.1	72.5	70.0	67.6	65.4	63.2	61.2	59.3	57.4	55.7
40	91.0	93.1	93.0	92.0	90.3	88.1	85.7	83.0	80.2	77.5	74.9	72.3	69.8	67.5	65.3	63.1	61.1	59.2	57.4	55.7
45	88.1	90.9	91.3	90.5	89.1	87.1	84.8	82.3	79.7	77.1	74.5	72.0	69.6	67.3	65.1	63.0	61.1	59.2	57.4	55.7
50	85.0	88.4	89.2	88.8	87.6	85.9	83.8	81.5	79.0	76.5	74.1	71.7	69.3	67.1	65.0	62.9	61.0	59.1	57.4	55.7
55	81.7	85.7	86.8	86.8	85.9	84.5	82.6	80.5	78.2	75.9	73.5	71.2	69.0	66.8	64.8	62.8	60.9	59.1	57.4	55.7
60	78.4	82.6	84.1	84.4	83.9	82.7	81.1	79.2	77.2	75.0	72.8	70.7	68.6	66.5	64.5	62.6	60.8	59.0	57.3	55.7
65	75.0	79.3	81.1	81.7	81.5	80.7	79.4	77.8	76.0	74.0	72.0	70.0	68.0	66.1	64.2	62.3	60.6	58.9	57.3	55.7
70	71.7	75.9	77.9	78.7	78.7	78.2	77.3	76.0	74.4	72.7	71.0	69.1	67.3	65.5	63.8	62.0	60.4	58.8	57.2	55.7
75	68.7	72.5	74.4	75.4	75.6	75.3	74.7	73.7	72.5	71.1	69.6	68.0	66.4	64.8	63.2	61.6	60.1	58.6	57.1	55.7
80	65.9	69.0	70.8	71.7	72.1	72.1	71.7	71.0	70.1	69.0	67.8	66.6	65.2	63.9	62.5	61.1	59.7	58.3	57.0	55.7
85	63.5	65.7	67.1	67.9	68.3	68.3	68.1	67.7	67.1	66.4	65.5	64.6	63.6	62.5	61.4	60.3	59.1	58.0	56.8	55.7
90	61.2	62.4	63.2	63.8	64.1	64.2	64.1	63.9	63.6	63.2	62.7	62.1	61.4	60.7	59.9	59.1	58.3	57.4	56.6	55.7
95	58.7	59.1	59.4	59.6	59.7	59.7	59.7	59.7	59.5	59.4	59.1	58.9	58.6	58.2	57.9	57.5	57.1	56.6	56.2	55.7
98	57.5	57.5	57.5	57.5	57.5	57.4	57.4	57.3	57.2	57.1	57.0	56.9	56.8	56.6	56.5	56.4	56.2	56.0	55.9	55.7

Mean Annual Mass Removal Efficiencies for 1.00-inches of Retention for Zone 4

NDCIA CN	Percent DCIA																			
	5	10	15	20	25	30	35	40	45	50	55	60	65	70	75	80	85	90	95	100
30	96.6	97.5	97.2	96.4	95.2	93.7	91.9	90.0	87.9	85.7	83.5	81.2	79.0	76.9	74.8	72.8	70.9	69.1	67.3	65.6
35	95.0	96.3	96.2	95.6	94.5	93.1	91.4	89.6	87.5	85.4	83.2	81.1	78.9	76.8	74.8	72.8	70.9	69.0	67.2	65.6
40	93.0	94.9	95.1	94.6	93.6	92.4	90.8	89.0	87.1	85.1	82.9	80.8	78.7	76.7	74.7	72.7	70.8	69.0	67.2	65.6
45	90.8	93.1	93.6	93.4	92.6	91.5	90.0	88.4	86.5	84.6	82.6	80.5	78.5	76.5	74.5	72.6	70.7	68.9	67.2	65.6
50	88.3	91.1	92.0	91.9	91.4	90.4	89.1	87.6	85.9	84.0	82.1	80.1	78.2	76.2	74.3	72.5	70.6	68.9	67.2	65.6
55	85.7	89.0	90.1	90.2	89.9	89.1	88.0	86.6	85.1	83.4	81.5	79.7	77.8	75.9	74.1	72.3	70.5	68.8	67.1	65.6
60	83.1	86.6	87.9	88.3	88.1	87.6	86.7	85.5	84.1	82.5	80.8	79.1	77.3	75.6	73.8	72.1	70.4	68.7	67.1	65.6
65	80.4	83.9	85.5	86.1	86.1	85.8	85.1	84.1	82.9	81.5	80.0	78.4	76.8	75.1	73.5	71.8	70.2	68.6	67.1	65.6
70	77.7	81.2	82.8	83.6	83.9	83.7	83.2	82.4	81.4	80.3	78.9	77.5	76.0	74.5	73.0	71.5	70.0	68.5	67.0	65.6
75	75.2	78.4	80.1	81.0	81.3	81.3	81.0	80.4	79.6	78.7	77.6	76.4	75.1	73.8	72.4	71.0	69.6	68.3	66.9	65.6
80	73.0	75.6	77.2	78.1	78.5	78.6	78.4	78.1	77.5	76.8	75.9	74.9	73.9	72.8	71.6	70.4	69.2	68.0	66.8	65.6
85	71.1	73.0	74.2	75.0	75.4	75.6	75.5	75.3	74.9	74.4	73.8	73.1	72.3	71.4	70.5	69.6	68.6	67.6	66.6	65.6
90	69.4	70.5	71.2	71.7	72.0	72.2	72.2	72.1	71.9	71.6	71.2	70.8	70.3	69.7	69.1	68.5	67.8	67.1	66.3	65.6
95	67.6	67.9	68.1	68.3	68.4	68.5	68.5	68.5	68.4	68.3	68.2	68.0	67.8	67.6	67.3	67.0	66.7	66.3	65.9	65.6
98	66.7	66.8	66.8	66.8	66.8	66.7	66.7	66.7	66.6	66.6	66.5	66.4	66.3	66.3	66.1	66.0	65.9	65.8	65.7	65.6

Mean Annual Mass Removal Efficiencies for 1.25-inches of Retention for Zone 4

NDCIA CN	Percent DCIA																			
	5	10	15	20	25	30	35	40	45	50	55	60	65	70	75	80	85	90	95	100
30	97.3	98.0	98.0	97.5	96.8	95.8	94.6	93.3	91.8	90.2	88.5	86.8	85.0	83.2	81.4	79.6	77.9	76.2	74.5	72.9
35	95.9	97.2	97.3	96.9	96.2	95.3	94.2	92.9	91.5	89.9	88.3	86.6	84.8	83.0	81.3	79.5	77.8	76.2	74.5	72.9
40	94.5	96.0	96.3	96.1	95.5	94.6	93.6	92.4	91.1	89.6	88.0	86.3	84.6	82.9	81.2	79.5	77.8	76.1	74.5	72.9
45	92.7	94.6	95.1	95.0	94.6	93.9	93.0	91.8	90.6	89.1	87.6	86.0	84.4	82.7	81.0	79.3	77.7	76.1	74.5	72.9
50	90.7	93.1	93.8	93.8	93.6	93.0	92.1	91.1	89.9	88.6	87.2	85.7	84.1	82.4	80.8	79.2	77.6	76.0	74.5	72.9
55	88.6	91.3	92.2	92.5	92.3	91.9	91.2	90.3	89.2	88.0	86.6	85.2	83.7	82.1	80.6	79.0	77.5	75.9	74.4	72.9
60	86.4	89.3	90.5	90.9	90.9	90.6	90.0	89.2	88.3	87.2	86.0	84.6	83.2	81.8	80.3	78.8	77.3	75.8	74.4	72.9
65	84.3	87.2	88.5	89.1	89.2	89.0	88.6	88.0	87.2	86.3	85.2	84.0	82.7	81.3	79.9	78.5	77.1	75.7	74.3	72.9
70	82.1	85.0	86.4	87.1	87.4	87.3	87.0	86.6	85.9	85.1	84.2	83.1	82.0	80.7	79.5	78.2	76.9	75.6	74.3	72.9
75	80.1	82.7	84.1	84.9	85.3	85.4	85.2	84.9	84.4	83.7	82.9	82.0	81.1	80.0	78.9	77.7	76.6	75.4	74.2	72.9
80	78.2	80.4	81.7	82.5	83.0	83.2	83.1	82.9	82.5	82.0	81.4	80.7	79.9	79.1	78.1	77.1	76.1	75.1	74.0	72.9
85	76.7	78.3	79.3	80.1	80.5	80.7	80.7	80.6	80.4	80.1	79.6	79.1	78.5	77.8	77.1	76.4	75.5	74.7	73.8	72.9
90	75.4	76.3	77.0	77.5	77.8	78.0	78.1	78.0	77.9	77.7	77.5	77.1	76.8	76.3	75.9	75.3	74.8	74.2	73.6	72.9
95	74.2	74.5	74.7	74.9	75.0	75.1	75.1	75.1	75.1	75.0	74.9	74.8	74.6	74.5	74.3	74.0	73.8	73.5	73.3	72.9
98	73.7	73.7	73.7	73.7	73.7	73.7	73.7	73.7	73.7	73.6	73.6	73.6	73.5	73.4	73.4	73.3	73.2	73.1	73.0	72.9

Mean Annual Mass Removal Efficiencies for 1.50-inches of Retention for Zone 4

NDCIA CN	Percent DCIA																			
	5	10	15	20	25	30	35	40	45	50	55	60	65	70	75	80	85	90	95	100
30	97.8	98.4	98.5	98.2	97.7	97.1	96.2	95.3	94.2	93.0	91.7	90.4	89.0	87.5	86.0	84.5	83.0	81.5	80.0	78.5
35	96.7	97.7	97.9	97.7	97.3	96.6	95.8	94.9	93.9	92.8	91.5	90.2	88.8	87.4	85.9	84.4	82.9	81.4	80.0	78.5
40	95.5	96.8	97.1	97.0	96.6	96.1	95.4	94.5	93.5	92.4	91.2	89.9	88.6	87.2	85.8	84.3	82.9	81.4	80.0	78.5
45	94.1	95.7	96.2	96.2	95.9	95.4	94.8	94.0	93.1	92.0	90.9	89.7	88.4	87.0	85.6	84.2	82.8	81.3	79.9	78.5
50	92.5	94.4	95.1	95.2	95.0	94.6	94.1	93.3	92.5	91.5	90.5	89.3	88.1	86.8	85.4	84.1	82.7	81.3	79.9	78.5
55	90.8	93.0	93.8	94.0	94.0	93.7	93.2	92.6	91.8	91.0	90.0	88.9	87.7	86.5	85.2	83.9	82.5	81.2	79.9	78.5
60	88.9	91.3	92.3	92.7	92.8	92.6	92.2	91.7	91.0	90.3	89.4	88.4	87.3	86.1	84.9	83.7	82.4	81.1	79.8	78.5
65	87.1	89.6	90.7	91.3	91.4	91.3	91.1	90.6	90.1	89.4	88.6	87.7	86.8	85.7	84.6	83.4	82.2	81.0	79.8	78.5
70	85.4	87.8	89.0	89.6	89.9	89.9	89.7	89.4	89.0	88.4	87.7	87.0	86.1	85.1	84.1	83.1	82.0	80.8	79.7	78.5
75	83.8	85.9	87.1	87.8	88.2	88.3	88.2	88.0	87.7	87.2	86.7	86.0	85.3	84.4	83.6	82.6	81.6	80.6	79.6	78.5
80	82.2	84.0	85.2	85.9	86.3	86.4	86.5	86.4	86.2	85.8	85.4	84.9	84.3	83.6	82.9	82.1	81.2	80.4	79.5	78.5
85	81.0	82.3	83.2	83.8	84.2	84.4	84.5	84.5	84.4	84.2	83.9	83.5	83.0	82.5	82.0	81.4	80.7	80.0	79.3	78.5
90	80.0	80.7	81.3	81.8	82.1	82.3	82.4	82.4	82.4	82.2	82.1	81.8	81.6	81.2	80.9	80.5	80.0	79.6	79.1	78.5
95	79.1	79.4	79.6	79.8	79.9	80.0	80.1	80.1	80.1	80.1	80.0	79.9	79.8	79.7	79.6	79.4	79.2	79.0	78.8	78.5
98	79.0	79.0	79.0	79.1	79.1	79.1	79.1	79.1	79.0	79.0	79.0	79.0	78.9	78.9	78.8	78.8	78.7	78.7	78.6	78.5

Mean Annual Mass Removal Efficiencies for 1.75-inches of Retention for Zone 4

NDCIA CN	Percent DCIA																			
	5	10	15	20	25	30	35	40	45	50	55	60	65	70	75	80	85	90	95	100
30	98.2	98.7	98.8	98.7	98.4	97.9	97.3	96.5	95.7	94.8	93.8	92.8	91.7	90.5	89.3	88.0	86.7	85.4	84.1	82.8
35	97.3	98.1	98.3	98.2	97.9	97.5	96.9	96.2	95.5	94.6	93.6	92.6	91.5	90.4	89.2	87.9	86.7	85.4	84.1	82.8
40	96.2	97.4	97.7	97.7	97.4	97.0	96.5	95.9	95.1	94.3	93.4	92.4	91.3	90.2	89.0	87.8	86.6	85.4	84.1	82.8
45	95.1	96.5	96.9	97.0	96.8	96.5	96.0	95.4	94.7	93.9	93.1	92.1	91.1	90.0	88.9	87.7	86.5	85.3	84.1	82.8
50	93.9	95.5	96.0	96.1	96.0	95.8	95.4	94.8	94.2	93.5	92.7	91.8	90.8	89.8	88.7	87.6	86.4	85.2	84.0	82.8
55	92.4	94.3	95.0	95.2	95.2	95.0	94.6	94.2	93.6	93.0	92.2	91.4	90.5	89.5	88.5	87.4	86.3	85.2	84.0	82.8
60	90.9	92.9	93.7	94.1	94.2	94.0	93.8	93.4	92.9	92.4	91.7	90.9	90.1	89.2	88.2	87.2	86.2	85.1	83.9	82.8
65	89.4	91.4	92.4	92.9	93.0	93.0	92.8	92.5	92.1	91.6	91.0	90.4	89.6	88.8	87.9	87.0	86.0	84.9	83.9	82.8
70	87.9	89.9	90.9	91.5	91.7	91.8	91.7	91.5	91.2	90.7	90.3	89.7	89.0	88.3	87.5	86.6	85.7	84.8	83.8	82.8
75	86.5	88.4	89.4	90.0	90.3	90.5	90.4	90.3	90.1	89.7	89.3	88.9	88.3	87.7	87.0	86.2	85.4	84.6	83.7	82.8
80	85.3	86.8	87.8	88.4	88.8	88.9	89.0	88.9	88.8	88.6	88.3	87.9	87.4	86.9	86.4	85.7	85.1	84.4	83.6	82.8
85	84.3	85.4	86.2	86.7	87.1	87.3	87.4	87.4	87.3	87.2	87.0	86.7	86.4	86.0	85.6	85.1	84.6	84.0	83.4	82.8
90	83.5	84.1	84.7	85.0	85.3	85.5	85.7	85.7	85.7	85.6	85.5	85.4	85.2	84.9	84.7	84.4	84.0	83.7	83.3	82.8
95	82.9	83.2	83.4	83.6	83.7	83.8	83.9	83.9	83.9	83.9	83.9	83.8	83.8	83.7	83.6	83.5	83.3	83.2	83.0	82.8
98	83.0	83.1	83.1	83.1	83.1	83.1	83.2	83.2	83.2	83.1	83.1	83.1	83.1	83.1	83.0	83.0	83.0	82.9	82.9	82.8

Mean Annual Mass Removal Efficiencies for 2.00-inches of Retention for Zone 4

NDCIA CN	Percent DCIA																			
	5	10	15	20	25	30	35	40	45	50	55	60	65	70	75	80	85	90	95	100
30	98.5	99.0	99.1	99.0	98.7	98.4	98.0	97.4	96.8	96.1	95.3	94.5	93.6	92.6	91.6	90.6	89.5	88.4	87.3	86.1
35	97.8	98.5	98.6	98.6	98.4	98.1	97.7	97.1	96.5	95.9	95.1	94.3	93.4	92.5	91.5	90.5	89.4	88.4	87.3	86.1
40	96.9	97.8	98.1	98.1	98.0	97.7	97.3	96.8	96.2	95.6	94.9	94.1	93.3	92.4	91.4	90.4	89.4	88.3	87.2	86.1
45	95.9	97.1	97.5	97.6	97.5	97.2	96.8	96.4	95.9	95.3	94.6	93.8	93.0	92.2	91.3	90.3	89.3	88.3	87.2	86.1
50	94.9	96.3	96.7	96.9	96.8	96.6	96.3	95.9	95.4	94.9	94.2	93.6	92.8	92.0	91.1	90.2	89.2	88.2	87.2	86.1
55	93.7	95.3	95.9	96.1	96.1	95.9	95.7	95.3	94.9	94.4	93.8	93.2	92.5	91.7	90.9	90.0	89.1	88.1	87.1	86.1
60	92.5	94.1	94.9	95.1	95.2	95.1	95.0	94.7	94.3	93.9	93.4	92.8	92.1	91.4	90.6	89.8	88.9	88.0	87.1	86.1
65	91.2	92.9	93.7	94.1	94.3	94.3	94.1	93.9	93.6	93.2	92.8	92.3	91.7	91.0	90.3	89.6	88.8	87.9	87.1	86.1
70	89.9	91.6	92.5	92.9	93.2	93.2	93.2	93.0	92.8	92.5	92.1	91.7	91.2	90.6	90.0	89.3	88.6	87.8	87.0	86.1
75	88.7	90.2	91.2	91.7	92.0	92.1	92.1	92.0	91.9	91.6	91.3	91.0	90.5	90.1	89.5	88.9	88.3	87.6	86.9	86.1
80	87.7	89.0	89.8	90.3	90.7	90.9	90.9	90.9	90.8	90.6	90.4	90.1	89.8	89.4	89.0	88.5	88.0	87.4	86.8	86.1
85	86.9	87.8	88.5	89.0	89.3	89.5	89.6	89.6	89.6	89.5	89.4	89.2	88.9	88.7	88.3	88.0	87.6	87.1	86.6	86.1
90	86.3	86.8	87.3	87.6	87.9	88.0	88.2	88.2	88.3	88.2	88.2	88.1	87.9	87.8	87.6	87.3	87.1	86.8	86.5	86.1
95	85.9	86.1	86.3	86.5	86.6	86.7	86.8	86.8	86.8	86.9	86.9	86.8	86.8	86.8	86.7	86.6	86.5	86.4	86.3	86.1
98	86.1	86.2	86.2	86.2	86.3	86.3	86.3	86.3	86.3	86.3	86.3	86.3	86.3	86.3	86.3	86.2	86.2	86.2	86.2	86.1

Mean Annual Mass Removal Efficiencies for 0.25-inches of Retention for Zone 5

NDCIA CN	Percent DCIA																			
	5	10	15	20	25	30	35	40	45	50	55	60	65	70	75	80	85	90	95	100
30	83.0	80.8	74.1	67.0	60.7	55.3	50.7	46.8	43.4	40.4	37.8	35.5	33.5	31.7	30.1	28.6	27.3	26.1	25.0	24.0
35	77.3	77.4	72.0	65.6	59.8	54.7	50.2	46.4	43.1	40.2	37.6	35.4	33.4	31.6	30.0	28.6	27.3	26.1	25.0	24.0
40	71.3	73.5	69.4	63.9	58.6	53.8	49.6	45.9	42.7	39.9	37.4	35.2	33.3	31.5	30.0	28.5	27.3	26.1	25.0	24.0
45	65.3	69.3	66.5	61.9	57.2	52.8	48.8	45.3	42.3	39.6	37.1	35.0	33.1	31.4	29.9	28.5	27.2	26.0	25.0	24.0
50	59.6	64.8	63.4	59.6	55.5	51.6	47.9	44.7	41.7	39.2	36.8	34.8	32.9	31.3	29.8	28.4	27.2	26.0	25.0	24.0
55	54.0	60.2	59.9	57.1	53.7	50.2	46.9	43.9	41.1	38.7	36.5	34.5	32.7	31.1	29.6	28.3	27.1	26.0	24.9	24.0
60	49.0	55.7	56.3	54.4	51.6	48.6	45.6	42.9	40.4	38.1	36.0	34.1	32.4	30.9	29.5	28.2	27.0	25.9	24.9	24.0
65	44.5	51.0	52.5	51.4	49.3	46.8	44.2	41.8	39.5	37.4	35.5	33.7	32.1	30.6	29.3	28.1	26.9	25.9	24.9	24.0
70	40.5	46.5	48.5	48.1	46.6	44.7	42.6	40.5	38.4	36.6	34.8	33.2	31.7	30.3	29.1	27.9	26.8	25.8	24.9	24.0
75	37.0	42.0	44.2	44.5	43.7	42.2	40.6	38.9	37.2	35.5	34.0	32.5	31.2	29.9	28.8	27.7	26.7	25.7	24.8	24.0
80	33.9	37.8	39.8	40.5	40.2	39.4	38.2	36.9	35.6	34.2	32.9	31.7	30.5	29.4	28.4	27.4	26.5	25.6	24.8	24.0
85	31.1	33.8	35.4	36.1	36.3	35.9	35.3	34.5	33.5	32.5	31.5	30.5	29.6	28.7	27.8	27.0	26.2	25.4	24.7	24.0
90	28.7	30.2	31.2	31.8	32.0	32.0	31.7	31.3	30.8	30.2	29.6	29.0	28.3	27.6	27.0	26.4	25.7	25.1	24.6	24.0
95	26.6	27.0	27.4	27.6	27.7	27.7	27.7	27.6	27.4	27.2	26.9	26.6	26.3	26.0	25.7	25.4	25.0	24.7	24.3	24.0
98	25.7	25.7	25.7	25.7	25.7	25.6	25.6	25.5	25.4	25.3	25.2	25.1	25.0	24.8	24.7	24.6	24.4	24.3	24.1	24.0

Mean Annual Mass Removal Efficiencies for 0.50-inches of Retention for Zone 5

NDCIA CN	Percent DCIA																			
	5	10	15	20	25	30	35	40	45	50	55	60	65	70	75	80	85	90	95	100
30	88.6	89.9	87.9	84.5	80.5	76.4	72.3	68.5	65.1	61.9	58.9	56.2	53.7	51.4	49.3	47.3	45.5	43.8	42.2	40.8
35	84.1	86.8	85.6	82.8	79.3	75.4	71.6	68.0	64.6	61.5	58.7	56.0	53.6	51.3	49.2	47.3	45.5	43.8	42.2	40.8
40	79.3	83.3	82.9	80.8	77.8	74.3	70.7	67.3	64.1	61.1	58.3	55.8	53.4	51.1	49.1	47.2	45.4	43.8	42.2	40.8
45	74.4	79.5	80.0	78.5	76.0	72.9	69.6	66.5	63.4	60.6	57.9	55.4	53.1	51.0	48.9	47.1	45.3	43.7	42.2	40.8
50	69.7	75.5	76.8	76.0	73.9	71.3	68.4	65.5	62.6	60.0	57.4	55.0	52.8	50.7	48.8	47.0	45.3	43.7	42.2	40.8
55	65.2	71.4	73.4	73.1	71.7	69.5	66.9	64.3	61.7	59.2	56.9	54.6	52.5	50.4	48.6	46.8	45.2	43.6	42.1	40.8
60	61.0	67.2	69.7	70.1	69.2	67.4	65.3	63.0	60.6	58.4	56.2	54.0	52.0	50.1	48.3	46.6	45.0	43.5	42.1	40.8
65	57.1	63.1	65.9	66.8	66.4	65.1	63.3	61.4	59.4	57.3	55.3	53.4	51.5	49.7	48.0	46.4	44.9	43.4	42.1	40.8
70	53.6	59.2	62.0	63.2	63.3	62.5	61.2	59.6	57.9	56.1	54.3	52.6	50.9	49.2	47.6	46.1	44.7	43.3	42.0	40.8
75	50.7	55.5	58.1	59.5	59.8	59.4	58.6	57.4	56.1	54.6	53.1	51.6	50.1	48.6	47.1	45.8	44.4	43.2	41.9	40.8
80	48.3	52.0	54.3	55.5	56.0	56.0	55.6	54.8	53.9	52.8	51.6	50.3	49.0	47.8	46.5	45.3	44.1	43.0	41.8	40.8
85	46.2	48.7	50.5	51.5	52.0	52.2	52.1	51.7	51.1	50.4	49.6	48.6	47.6	46.7	45.6	44.6	43.7	42.7	41.7	40.8
90	44.2	45.6	46.7	47.4	47.9	48.1	48.2	48.1	47.8	47.4	46.9	46.4	45.7	45.1	44.4	43.7	43.0	42.2	41.5	40.8
95	42.5	43.0	43.4	43.7	43.9	44.0	44.1	44.1	44.0	43.9	43.7	43.5	43.2	43.0	42.7	42.3	42.0	41.6	41.2	40.8
98	42.1	42.2	42.2	42.2	42.2	42.2	42.2	42.1	42.1	42.0	41.9	41.8	41.7	41.6	41.5	41.4	41.2	41.1	40.9	40.8

Mean Annual Mass Removal Efficiencies for 0.75-inches of Retention for Zone 5

NDCIA CN	Percent DCIA																			
	5	10	15	20	25	30	35	40	45	50	55	60	65	70	75	80	85	90	95	100
30	91.4	93.0	92.4	90.8	88.5	85.9	83.0	80.1	77.2	74.4	71.6	69.1	66.7	64.4	62.3	60.2	58.3	56.5	54.8	53.2
35	87.7	90.5	90.4	89.2	87.2	84.8	82.2	79.5	76.7	73.9	71.3	68.8	66.5	64.2	62.1	60.2	58.3	56.5	54.8	53.2
40	83.8	87.6	88.1	87.2	85.7	83.6	81.2	78.7	76.0	73.4	70.9	68.5	66.2	64.1	62.0	60.0	58.2	56.4	54.8	53.2
45	80.0	84.4	85.6	85.1	83.9	82.2	80.0	77.7	75.3	72.8	70.4	68.1	65.9	63.8	61.8	59.9	58.1	56.4	54.7	53.2
50	76.0	81.1	82.7	82.8	82.0	80.5	78.7	76.6	74.4	72.1	69.8	67.7	65.6	63.5	61.6	59.8	58.0	56.3	54.7	53.2
55	72.3	77.7	79.7	80.2	79.8	78.7	77.2	75.3	73.3	71.2	69.2	67.1	65.1	63.2	61.3	59.6	57.9	56.2	54.7	53.2
60	68.9	74.2	76.5	77.4	77.4	76.6	75.4	73.9	72.1	70.2	68.3	66.4	64.6	62.8	61.0	59.3	57.7	56.1	54.6	53.2
65	65.5	70.7	73.3	74.5	74.7	74.4	73.5	72.2	70.7	69.1	67.4	65.7	64.0	62.3	60.7	59.1	57.5	56.0	54.6	53.2
70	62.6	67.4	70.0	71.3	71.9	71.8	71.2	70.3	69.1	67.7	66.3	64.7	63.2	61.7	60.2	58.7	57.3	55.9	54.5	53.2
75	60.1	64.2	66.7	68.1	68.8	68.9	68.7	68.0	67.1	66.1	64.9	63.6	62.3	60.9	59.6	58.3	57.0	55.7	54.4	53.2
80	58.0	61.3	63.5	64.8	65.5	65.9	65.8	65.4	64.8	64.0	63.1	62.1	61.1	60.0	58.9	57.7	56.6	55.4	54.3	53.2
85	56.4	58.8	60.4	61.5	62.2	62.5	62.6	62.4	62.0	61.6	61.0	60.3	59.5	58.7	57.9	57.0	56.0	55.1	54.1	53.2
90	55.1	56.4	57.4	58.1	58.6	58.9	59.0	59.0	58.9	58.7	58.4	58.0	57.6	57.1	56.5	55.9	55.3	54.6	53.9	53.2
95	53.7	54.2	54.6	54.9	55.2	55.4	55.5	55.6	55.6	55.5	55.5	55.3	55.2	55.0	54.7	54.5	54.2	53.9	53.5	53.2
98	53.9	54.0	54.0	54.1	54.1	54.1	54.1	54.1	54.1	54.1	54.0	53.9	53.9	53.8	53.7	53.6	53.5	53.4	53.3	53.2

Mean Annual Mass Removal Efficiencies for 1.00-inches of Retention for Zone 5

NDCIA CN	Percent DCIA																			
	5	10	15	20	25	30	35	40	45	50	55	60	65	70	75	80	85	90	95	100
30	93.5	94.8	94.6	93.7	92.3	90.6	88.7	86.5	84.3	82.1	79.8	77.6	75.4	73.3	71.3	69.4	67.5	65.8	64.1	62.5
35	90.2	92.6	92.9	92.3	91.1	89.6	87.8	85.9	83.8	81.6	79.5	77.3	75.2	73.1	71.2	69.3	67.5	65.7	64.0	62.5
40	87.0	90.2	91.0	90.7	89.7	88.4	86.8	85.0	83.1	81.1	79.0	77.0	74.9	72.9	71.0	69.1	67.4	65.7	64.0	62.5
45	83.7	87.6	88.8	88.8	88.1	87.1	85.7	84.1	82.3	80.4	78.5	76.5	74.6	72.7	70.8	69.0	67.3	65.6	64.0	62.5
50	80.5	84.8	86.4	86.8	86.4	85.5	84.4	83.0	81.4	79.7	77.9	76.0	74.2	72.3	70.5	68.8	67.1	65.5	64.0	62.5
55	77.3	82.0	83.9	84.5	84.4	83.9	83.0	81.8	80.3	78.8	77.1	75.4	73.7	72.0	70.3	68.6	67.0	65.4	63.9	62.5
60	74.4	79.1	81.1	82.0	82.2	82.0	81.3	80.3	79.2	77.8	76.3	74.7	73.1	71.5	69.9	68.3	66.8	65.3	63.9	62.5
65	71.8	76.1	78.3	79.5	79.9	79.9	79.5	78.7	77.8	76.6	75.3	73.9	72.4	71.0	69.5	68.0	66.6	65.2	63.8	62.5
70	69.2	73.2	75.5	76.8	77.4	77.6	77.4	76.9	76.2	75.3	74.2	72.9	71.6	70.3	69.0	67.7	66.3	65.0	63.7	62.5
75	67.0	70.6	72.8	74.1	74.8	75.1	74.8	74.3	73.6	72.7	71.7	70.7	69.7	69.5	68.4	67.2	66.0	64.8	63.6	62.5
80	65.3	68.1	70.0	71.3	72.1	72.5	72.6	72.5	72.2	71.7	71.0	70.3	69.4	68.5	67.6	66.6	65.6	64.5	63.5	62.5
85	63.9	66.0	67.5	68.6	69.3	69.7	69.9	69.9	69.8	69.5	69.0	68.5	67.9	67.2	66.5	65.8	65.0	64.2	63.3	62.5
90	63.0	64.3	65.2	65.9	66.4	66.8	67.0	67.1	67.0	66.9	66.7	66.4	66.1	65.7	65.2	64.7	64.2	63.6	63.1	62.5
95	62.3	62.8	63.1	63.4	63.6	63.8	63.9	64.0	64.1	64.1	64.1	64.0	63.9	63.8	63.6	63.4	63.2	63.0	62.7	62.5
98	62.6	62.7	62.8	62.8	62.9	62.9	62.9	62.9	62.9	62.9	62.9	62.9	62.9	62.8	62.8	62.7	62.7	62.6	62.5	62.5

Mean Annual Mass Removal Efficiencies for 1.25-inches of Retention for Zone 5

NDCIA CN	Percent DCIA																			
	5	10	15	20	25	30	35	40	45	50	55	60	65	70	75	80	85	90	95	100
30	95.1	96.1	96.0	95.4	94.5	93.3	91.9	90.4	88.7	86.9	85.1	83.3	81.5	79.7	77.8	76.1	74.4	72.7	71.1	69.5
35	92.3	94.2	94.5	94.2	93.4	92.4	91.1	89.7	88.2	86.5	84.8	83.0	81.2	79.5	77.7	76.0	74.3	72.6	71.1	69.5
40	89.3	92.0	92.8	92.8	92.2	91.3	90.2	88.9	87.5	85.9	84.3	82.6	80.9	79.2	77.5	75.8	74.2	72.6	71.0	69.5
45	86.5	89.8	90.9	91.2	90.9	90.1	89.2	88.0	86.7	85.3	83.8	82.2	80.6	78.9	77.3	75.7	74.1	72.5	71.0	69.5
50	83.8	87.5	88.9	89.5	89.3	88.8	88.0	87.0	85.8	84.5	83.1	81.7	80.2	78.6	77.0	75.5	73.9	72.4	71.0	69.5
55	81.2	85.1	86.8	87.5	87.5	87.2	86.6	85.8	84.8	83.7	82.4	81.1	79.7	78.2	76.7	75.3	73.8	72.3	70.9	69.5
60	78.6	82.7	84.6	85.4	85.6	85.5	85.1	84.5	83.7	82.7	81.6	80.4	79.1	77.8	76.4	75.0	73.6	72.2	70.9	69.5
65	76.4	80.3	82.2	83.1	83.6	83.7	83.5	83.1	82.4	81.6	80.7	79.6	78.5	77.2	76.0	74.7	73.4	72.1	70.8	69.5
70	74.3	77.7	79.7	80.8	81.5	81.7	81.7	81.4	80.9	80.3	79.5	78.7	77.7	76.6	75.4	74.3	73.1	71.9	70.7	69.5
75	72.4	75.4	77.3	78.5	79.2	79.6	79.7	79.6	79.3	78.8	78.2	77.5	76.7	75.8	74.8	73.8	72.7	71.7	70.6	69.5
80	70.8	73.3	75.1	76.2	76.9	77.4	77.6	77.6	77.4	77.1	76.7	76.2	75.5	74.8	74.0	73.2	72.3	71.4	70.5	69.5
85	69.8	71.6	72.9	73.9	74.6	75.0	75.3	75.4	75.4	75.2	75.0	74.6	74.1	73.6	73.0	72.4	71.7	71.0	70.3	69.5
90	69.2	70.3	71.1	71.8	72.3	72.6	72.9	73.0	73.1	73.1	72.9	72.7	72.5	72.2	71.8	71.4	71.0	70.5	70.0	69.5
95	68.9	69.3	69.7	70.0	70.2	70.4	70.5	70.6	70.7	70.7	70.7	70.7	70.6	70.5	70.4	70.3	70.1	69.9	69.7	69.5
98	69.4	69.5	69.6	69.6	69.7	69.7	69.8	69.8	69.8	69.8	69.8	69.8	69.8	69.8	69.7	69.7	69.7	69.6	69.6	69.5

Mean Annual Mass Removal Efficiencies for 1.50-inches of Retention for Zone 5

NDCIA CN	Percent DCIA																			
	5	10	15	20	25	30	35	40	45	50	55	60	65	70	75	80	85	90	95	100
30	96.3	97.1	97.0	96.5	95.9	95.0	93.9	92.8	91.5	90.2	88.7	87.2	85.7	84.1	82.6	81.1	79.5	78.0	76.5	75.1
35	93.9	95.4	95.6	95.4	95.0	94.2	93.2	92.2	91.0	89.7	88.3	86.9	85.4	83.9	82.4	81.0	79.5	78.0	76.5	75.1
40	91.3	93.5	94.1	94.2	93.9	93.3	92.4	91.5	90.4	89.2	87.9	86.5	85.1	83.7	82.3	80.8	79.4	77.9	76.5	75.1
45	88.8	91.5	92.5	92.8	92.7	92.2	91.5	90.6	89.6	88.6	87.4	86.1	84.8	83.4	82.0	80.6	79.2	77.8	76.4	75.1
50	86.4	89.6	90.8	91.3	91.4	91.0	90.4	89.7	88.8	87.9	86.8	85.6	84.4	83.1	81.8	80.4	79.1	77.7	76.4	75.1
55	84.2	87.5	89.0	89.7	89.8	89.6	89.2	88.6	87.9	87.1	86.1	85.0	83.9	82.7	81.5	80.2	78.9	77.6	76.3	75.1
60	81.9	85.4	87.1	87.9	88.2	88.1	87.9	87.4	86.9	86.2	85.3	84.4	83.3	82.2	81.1	79.9	78.7	77.5	76.3	75.1
65	80.0	83.4	85.1	86.0	86.4	86.5	86.4	86.1	85.7	85.1	84.4	83.6	82.7	81.7	80.7	79.6	78.5	77.4	76.2	75.1
70	78.3	81.3	83.0	84.0	84.5	84.8	84.8	84.7	84.4	83.9	83.4	82.7	81.9	81.1	80.2	79.3	78.2	77.2	76.1	75.1
75	76.6	79.3	80.9	81.9	82.6	83.0	83.1	83.1	82.9	82.6	82.2	81.6	81.0	80.4	79.6	78.8	77.9	77.0	76.0	75.1
80	75.3	77.4	78.9	79.9	80.6	81.1	81.3	81.4	81.3	81.1	80.8	80.4	80.0	79.5	78.9	78.2	77.5	76.7	75.9	75.1
85	74.4	76.0	77.2	78.0	78.7	79.1	79.4	79.5	79.5	79.5	79.3	79.1	78.8	78.4	78.0	77.5	76.9	76.3	75.7	75.1
90	73.9	74.9	75.7	76.3	76.8	77.1	77.4	77.6	77.7	77.7	77.7	77.6	77.4	77.2	76.9	76.6	76.3	75.9	75.5	75.1
95	74.0	74.4	74.7	75.0	75.2	75.4	75.6	75.7	75.8	75.8	75.9	75.9	75.9	75.8	75.7	75.6	75.5	75.4	75.2	75.1
98	74.8	74.9	75.0	75.0	75.1	75.1	75.1	75.2	75.2	75.2	75.2	75.2	75.2	75.2	75.2	75.2	75.2	75.1	75.1	75.1

Mean Annual Mass Removal Efficiencies for 1.75-inches of Retention for Zone 5

NDCIA CN	Percent DCIA																			
	5	10	15	20	25	30	35	40	45	50	55	60	65	70	75	80	85	90	95	100
30	97.2	97.7	97.7	97.4	96.8	96.2	95.4	94.4	93.5	92.4	91.2	90.0	88.7	87.4	86.1	84.8	83.4	82.1	80.8	79.4
35	95.1	96.3	96.6	96.4	96.0	95.5	94.7	93.9	93.0	91.9	90.8	89.7	88.5	87.2	85.9	84.6	83.3	82.0	80.7	79.4
40	92.9	94.7	95.2	95.2	95.0	94.6	94.0	93.2	92.4	91.4	90.4	89.3	88.2	87.0	85.7	84.5	83.2	82.0	80.7	79.4
45	90.7	93.0	93.7	94.0	94.0	93.7	93.2	92.5	91.7	90.9	89.9	88.9	87.8	86.7	85.5	84.3	83.1	81.9	80.7	79.4
50	88.5	91.2	92.2	92.7	92.8	92.6	92.2	91.7	91.0	90.2	89.4	88.4	87.4	86.4	85.3	84.1	83.0	81.8	80.6	79.4
55	86.5	89.4	90.7	91.3	91.5	91.5	91.2	90.7	90.2	89.5	88.7	87.9	87.0	86.0	85.0	83.9	82.8	81.7	80.6	79.4
60	84.6	87.5	89.0	89.8	90.2	90.2	90.0	89.6	89.2	88.6	88.0	87.3	86.4	85.6	84.6	83.6	82.6	81.6	80.5	79.4
65	82.9	85.8	87.4	88.3	88.6	88.7	88.7	88.5	88.1	87.7	87.2	86.6	85.8	85.1	84.2	83.3	82.4	81.4	80.5	79.4
70	81.4	84.1	85.6	86.5	87.0	87.2	87.2	87.2	87.0	86.6	86.2	85.7	85.1	84.5	83.7	83.0	82.1	81.3	80.4	79.4
75	80.2	82.4	83.8	84.7	85.2	85.6	85.8	85.8	85.7	85.5	85.2	84.8	84.3	83.8	83.2	82.5	81.8	81.1	80.3	79.4
80	78.9	80.8	82.0	82.9	83.5	84.0	84.2	84.3	84.3	84.2	84.0	83.7	83.4	83.0	82.5	82.0	81.4	80.8	80.1	79.4
85	78.1	79.5	80.5	81.3	81.9	82.3	82.6	82.8	82.8	82.8	82.7	82.5	82.3	82.1	81.7	81.4	81.0	80.5	80.0	79.4
90	77.8	78.6	79.3	79.9	80.4	80.7	80.9	81.1	81.2	81.3	81.3	81.2	81.1	81.0	80.9	80.6	80.4	80.1	79.8	79.4
95	78.0	78.4	78.7	78.9	79.1	79.3	79.5	79.6	79.7	79.8	79.9	79.9	79.9	79.9	79.9	79.8	79.8	79.7	79.6	79.4
98	79.0	79.0	79.1	79.2	79.2	79.3	79.3	79.4	79.4	79.4	79.5	79.5	79.5	79.5	79.5	79.5	79.5	79.5	79.5	79.4

Mean Annual Mass Removal Efficiencies for 2.00-inches of Retention for Zone 5

NDCIA CN	Percent DCIA																			
	5	10	15	20	25	30	35	40	45	50	55	60	65	70	75	80	85	90	95	100
30	97.8	98.3	98.3	98.0	97.5	97.0	96.4	95.6	94.8	93.9	93.0	92.0	91.0	89.9	88.7	87.6	86.4	85.2	84.0	82.9
35	96.2	97.1	97.3	97.1	96.8	96.3	95.8	95.1	94.4	93.6	92.7	91.7	90.7	89.7	88.6	87.4	86.3	85.2	84.0	82.9
40	94.3	95.7	96.1	96.1	95.9	95.6	95.2	94.5	93.8	93.1	92.3	91.4	90.4	89.4	88.4	87.3	86.2	85.1	84.0	82.9
45	92.3	94.2	94.8	95.0	94.9	94.8	94.4	93.9	93.3	92.6	91.8	91.0	90.1	89.2	88.2	87.1	86.1	85.0	83.9	82.9
50	90.3	92.5	93.4	93.8	93.9	93.8	93.6	93.1	92.6	92.0	91.3	90.5	89.7	88.8	87.9	87.0	86.0	84.9	83.9	82.9
55	88.4	90.9	92.0	92.6	92.8	92.8	92.6	92.3	91.8	91.3	90.7	90.0	89.3	88.5	87.6	86.7	85.8	84.8	83.9	82.9
60	86.8	89.3	90.6	91.3	91.6	91.7	91.6	91.3	91.0	90.6	90.0	89.4	88.8	88.1	87.3	86.5	85.6	84.7	83.8	82.9
65	85.3	87.7	89.1	90.0	90.4	90.5	90.5	90.3	90.0	89.7	89.3	88.8	88.2	87.6	86.9	86.2	85.4	84.6	83.7	82.9
70	83.9	86.3	87.7	88.5	88.9	89.2	89.2	89.1	89.0	88.8	88.4	88.0	87.6	87.1	86.5	85.8	85.1	84.4	83.7	82.9
75	82.9	84.9	86.2	87.0	87.4	87.7	87.9	87.9	87.9	87.7	87.5	87.2	86.9	86.4	86.0	85.4	84.8	84.2	83.6	82.9
80	81.9	83.5	84.6	85.4	85.9	86.3	86.5	86.7	86.7	86.6	86.5	86.3	86.1	85.7	85.4	84.9	84.5	84.0	83.4	82.9
85	81.1	82.3	83.3	84.0	84.5	84.9	85.1	85.3	85.4	85.4	85.4	85.3	85.1	84.9	84.7	84.4	84.1	83.7	83.3	82.9
90	80.9	81.7	82.3	82.8	83.2	83.5	83.8	84.0	84.1	84.2	84.2	84.2	84.1	84.0	83.9	83.8	83.6	83.4	83.1	82.9
95	81.3	81.6	81.9	82.1	82.3	82.5	82.6	82.8	82.9	83.0	83.0	83.1	83.1	83.1	83.1	83.1	83.1	83.0	82.9	82.9
98	82.3	82.3	82.4	82.5	82.5	82.6	82.6	82.7	82.7	82.7	82.8	82.8	82.8	82.8	82.8	82.9	82.9	82.9	82.9	82.9

Mean Annual Mass Removal Efficiencies for 2.25-inches of Retention for Zone 5

NDCIA CN	Percent DCIA																			
	5	10	15	20	25	30	35	40	45	50	55	60	65	70	75	80	85	90	95	100
30	98.2	98.7	98.6	98.5	98.1	97.6	97.1	96.5	95.9	95.1	94.3	93.5	92.6	91.7	90.7	89.7	88.7	87.7	86.6	85.6
35	97.0	97.7	97.8	97.7	97.5	97.0	96.6	96.1	95.4	94.7	94.0	93.2	92.4	91.5	90.6	89.6	88.6	87.6	86.6	85.6
40	95.3	96.5	96.9	96.8	96.6	96.3	96.0	95.5	95.0	94.3	93.6	92.9	92.1	91.3	90.4	89.5	88.5	87.6	86.6	85.6
45	93.6	95.2	95.7	95.8	95.7	95.6	95.3	94.9	94.4	93.9	93.2	92.6	91.8	91.0	90.2	89.3	88.4	87.5	86.5	85.6
50	91.9	93.7	94.5	94.7	94.8	94.8	94.6	94.3	93.8	93.3	92.8	92.1	91.5	90.7	90.0	89.1	88.3	87.4	86.5	85.6
55	90.1	92.2	93.2	93.6	93.8	93.9	93.8	93.5	93.2	92.7	92.2	91.7	91.1	90.4	89.7	88.9	88.1	87.3	86.5	85.6
60	88.6	90.8	91.9	92.5	92.8	92.9	92.9	92.7	92.4	92.0	91.6	91.1	90.6	90.0	89.4	88.7	88.0	87.2	86.4	85.6
65	87.2	89.4	90.6	91.3	91.7	91.9	91.9	91.8	91.6	91.3	90.9	90.6	90.1	89.6	89.0	88.4	87.8	87.1	86.3	85.6
70	86.0	88.1	89.3	90.1	90.6	90.8	90.8	90.8	90.6	90.4	90.2	89.9	89.5	89.1	88.6	88.1	87.5	86.9	86.3	85.6
75	85.1	87.0	88.1	88.8	89.3	89.5	89.6	89.7	89.6	89.6	89.4	89.1	88.9	88.5	88.2	87.7	87.2	86.7	86.2	85.6
80	84.5	85.8	86.8	87.5	87.9	88.2	88.4	88.6	88.6	88.6	88.5	88.3	88.1	87.9	87.6	87.3	86.9	86.5	86.1	85.6
85	83.8	84.8	85.6	86.1	86.6	87.0	87.2	87.4	87.5	87.5	87.5	87.5	87.4	87.2	87.0	86.8	86.5	86.3	85.9	85.6
90	83.5	84.2	84.7	85.2	85.6	85.8	86.1	86.2	86.4	86.5	86.5	86.5	86.5	86.5	86.4	86.3	86.1	86.0	85.8	85.6
95	83.9	84.2	84.5	84.7	84.9	85.1	85.2	85.3	85.4	85.5	85.6	85.6	85.7	85.7	85.7	85.7	85.7	85.7	85.6	85.6
98	84.9	85.0	85.1	85.1	85.2	85.2	85.3	85.3	85.4	85.4	85.4	85.5	85.5	85.5	85.5	85.5	85.6	85.6	85.6	85.6

Mean Annual Mass Removal Efficiencies for 2.50-inches of Retention for Zone 5

NDCIA CN	Percent DCIA																			
	5	10	15	20	25	30	35	40	45	50	55	60	65	70	75	80	85	90	95	100
30	98.6	98.9	98.9	98.8	98.6	98.2	97.7	97.2	96.7	96.0	95.3	94.6	93.9	93.1	92.3	91.4	90.6	89.6	88.7	87.8
35	97.6	98.1	98.3	98.2	98.0	97.6	97.2	96.8	96.3	95.7	95.0	94.4	93.7	92.9	92.1	91.3	90.5	89.6	88.7	87.8
40	96.2	97.1	97.4	97.4	97.3	97.0	96.7	96.3	95.9	95.3	94.7	94.1	93.4	92.7	92.0	91.2	90.4	89.5	88.7	87.8
45	94.7	96.0	96.5	96.5	96.5	96.3	96.0	95.8	95.4	94.9	94.3	93.8	93.2	92.5	91.8	91.0	90.3	89.5	88.6	87.8
50	93.2	94.8	95.3	95.6	95.6	95.5	95.4	95.2	94.8	94.4	93.9	93.4	92.8	92.2	91.6	90.9	90.1	89.4	88.6	87.8
55	91.6	93.4	94.2	94.5	94.7	94.7	94.7	94.5	94.2	93.9	93.4	93.0	92.5	91.9	91.3	90.7	90.0	89.3	88.5	87.8
60	90.1	92.0	93.0	93.5	93.8	93.9	93.9	93.8	93.5	93.2	92.9	92.5	92.0	91.6	91.0	90.4	89.8	89.2	88.5	87.8
65	88.9	90.8	91.8	92.4	92.8	93.0	93.1	93.0	92.8	92.6	92.3	92.0	91.6	91.2	90.7	90.2	89.6	89.1	88.4	87.8
70	87.8	89.6	90.7	91.4	91.8	92.1	92.1	92.1	92.0	91.8	91.6	91.4	91.1	90.7	90.3	89.9	89.4	88.9	88.4	87.8
75	86.9	88.6	89.6	90.3	90.8	91.0	91.1	91.1	91.1	91.0	90.9	90.7	90.5	90.2	89.9	89.5	89.2	88.7	88.3	87.8
80	86.4	87.7	88.6	89.2	89.6	89.9	90.0	90.1	90.2	90.2	90.1	90.0	89.8	89.7	89.4	89.2	88.9	88.5	88.2	87.8
85	85.9	86.9	87.5	88.0	88.4	88.7	88.9	89.1	89.2	89.3	89.3	89.2	89.2	89.1	88.9	88.8	88.6	88.3	88.1	87.8
90	85.6	86.2	86.7	87.1	87.5	87.8	88.0	88.1	88.3	88.4	88.4	88.4	88.4	88.4	88.4	88.3	88.2	88.1	87.9	87.8
95	86.1	86.4	86.6	86.8	87.0	87.1	87.3	87.4	87.5	87.6	87.7	87.7	87.8	87.8	87.8	87.8	87.8	87.8	87.8	87.8
98	87.1	87.2	87.2	87.3	87.3	87.4	87.4	87.5	87.5	87.6	87.6	87.6	87.7	87.7	87.7	87.7	87.7	87.8	87.8	87.8

Mean Annual Mass Removal Efficiencies for 2.75-inches of Retention for Zone 5

NDCIA CN	Percent DCIA																			
	5	10	15	20	25	30	35	40	45	50	55	60	65	70	75	80	85	90	95	100
30	98.9	99.1	99.1	99.1	98.9	98.6	98.2	97.8	97.3	96.7	96.2	95.5	94.9	94.2	93.5	92.8	92.0	91.2	90.4	89.6
35	98.1	98.5	98.6	98.6	98.4	98.1	97.7	97.4	96.9	96.4	95.9	95.3	94.7	94.1	93.4	92.7	91.9	91.2	90.4	89.6
40	97.0	97.7	97.9	97.9	97.8	97.5	97.2	96.9	96.5	96.1	95.6	95.0	94.5	93.9	93.2	92.5	91.8	91.1	90.3	89.6
45	95.6	96.7	97.1	97.1	97.1	96.9	96.6	96.4	96.1	95.7	95.2	94.7	94.2	93.6	93.0	92.4	91.7	91.0	90.3	89.6
50	94.3	95.6	96.1	96.3	96.3	96.2	96.0	95.8	95.6	95.3	94.9	94.4	93.9	93.4	92.8	92.2	91.6	91.0	90.3	89.6
55	92.9	94.4	95.0	95.3	95.4	95.4	95.4	95.3	95.1	94.8	94.4	94.0	93.6	93.1	92.6	92.1	91.5	90.9	90.2	89.6
60	91.6	93.2	93.9	94.3	94.6	94.7	94.7	94.6	94.5	94.2	93.9	93.6	93.2	92.8	92.3	91.8	91.3	90.8	90.2	89.6
65	90.3	92.0	92.8	93.4	93.7	93.9	94.0	93.9	93.8	93.6	93.4	93.1	92.8	92.4	92.0	91.6	91.1	90.6	90.1	89.6
70	89.3	90.9	91.8	92.4	92.8	93.1	93.2	93.2	93.1	93.0	92.8	92.6	92.3	92.0	91.7	91.3	90.9	90.5	90.1	89.6
75	88.5	89.9	90.9	91.5	91.9	92.2	92.3	92.4	92.3	92.2	92.1	92.0	91.8	91.6	91.3	91.0	90.7	90.4	90.0	89.6
80	88.1	89.2	90.0	90.6	91.0	91.2	91.4	91.5	91.5	91.5	91.4	91.4	91.3	91.1	90.9	90.7	90.5	90.2	89.9	89.6
85	87.8	88.6	89.2	89.6	90.0	90.2	90.4	90.5	90.6	90.7	90.7	90.7	90.7	90.6	90.5	90.3	90.2	90.0	89.8	89.6
90	87.5	88.0	88.4	88.8	89.1	89.3	89.5	89.7	89.8	89.9	90.0	90.0	90.0	90.0	90.0	89.9	89.9	89.8	89.7	89.6
95	87.9	88.2	88.4	88.6	88.7	88.9	89.0	89.1	89.2	89.3	89.4	89.4	89.5	89.5	89.5	89.6	89.6	89.6	89.6	89.6
98	88.9	88.9	89.0	89.0	89.1	89.1	89.2	89.2	89.3	89.3	89.4	89.4	89.4	89.5	89.5	89.5	89.5	89.5	89.5	89.6

Mean Annual Mass Removal Efficiencies for 3.00-inches of Retention for Zone 5

NDCIA CN	Percent DCIA																			
	5	10	15	20	25	30	35	40	45	50	55	60	65	70	75	80	85	90	95	100
30	99.1	99.3	99.3	99.2	99.1	98.9	98.6	98.2	97.8	97.3	96.8	96.3	95.7	95.1	94.5	93.8	93.2	92.5	91.8	91.0
35	98.4	98.8	98.9	98.8	98.7	98.5	98.2	97.8	97.5	97.0	96.6	96.1	95.5	94.9	94.4	93.7	93.1	92.4	91.7	91.0
40	97.5	98.1	98.3	98.3	98.2	98.0	97.7	97.4	97.1	96.7	96.3	95.8	95.3	94.8	94.2	93.6	93.0	92.4	91.7	91.0
45	96.4	97.3	97.6	97.6	97.6	97.4	97.2	96.9	96.7	96.4	96.0	95.5	95.1	94.6	94.0	93.5	92.9	92.3	91.7	91.0
50	95.2	96.3	96.7	96.9	96.9	96.8	96.6	96.4	96.2	96.0	95.6	95.2	94.8	94.3	93.9	93.4	92.8	92.2	91.6	91.0
55	94.0	95.3	95.8	96.0	96.1	96.1	96.0	95.9	95.7	95.5	95.2	94.9	94.5	94.1	93.6	93.2	92.7	92.2	91.6	91.0
60	92.8	94.1	94.8	95.1	95.3	95.4	95.4	95.3	95.2	95.0	94.8	94.5	94.1	93.8	93.4	93.0	92.5	92.1	91.6	91.0
65	91.7	93.0	93.8	94.2	94.5	94.6	94.7	94.7	94.6	94.5	94.3	94.0	93.8	93.5	93.1	92.8	92.4	91.9	91.5	91.0
70	90.7	92.0	92.8	93.3	93.7	93.9	94.0	94.1	94.0	93.9	93.8	93.6	93.3	93.1	92.8	92.5	92.2	91.8	91.4	91.0
75	89.9	91.1	91.9	92.5	92.9	93.2	93.3	93.3	93.3	93.3	93.2	93.0	92.9	92.7	92.5	92.3	92.0	91.7	91.4	91.0
80	89.4	90.5	91.2	91.7	92.1	92.3	92.5	92.6	92.6	92.6	92.5	92.4	92.4	92.3	92.1	92.0	91.8	91.5	91.3	91.0
85	89.3	90.0	90.5	90.9	91.3	91.5	91.6	91.8	91.8	91.9	91.9	91.9	91.9	91.8	91.7	91.6	91.5	91.4	91.2	91.0
90	89.1	89.6	89.9	90.2	90.5	90.7	90.9	91.0	91.1	91.2	91.3	91.3	91.3	91.4	91.3	91.3	91.3	91.2	91.1	91.0
95	89.5	89.7	89.9	90.0	90.2	90.3	90.4	90.5	90.6	90.7	90.8	90.8	90.9	90.9	91.0	91.0	91.0	91.0	91.0	91.0
98	90.3	90.4	90.5	90.5	90.6	90.6	90.6	90.7	90.7	90.8	90.8	90.8	90.9	90.9	90.9	90.9	91.0	91.0	91.0	91.0

Mean Annual Mass Removal Efficiencies for 3.25-inches of Retention for Zone 5

NDCIA CN	Percent DCIA																			
	5	10	15	20	25	30	35	40	45	50	55	60	65	70	75	80	85	90	95	100
30	99.3	99.4	99.5	99.4	99.3	99.1	98.9	98.6	98.2	97.8	97.4	96.9	96.4	95.8	95.3	94.7	94.1	93.5	92.9	92.2
35	98.7	99.0	99.1	99.0	99.0	98.8	98.5	98.2	97.9	97.5	97.1	96.7	96.2	95.7	95.2	94.6	94.1	93.5	92.9	92.2
40	98.0	98.4	98.6	98.6	98.5	98.4	98.1	97.8	97.5	97.2	96.9	96.5	96.0	95.5	95.0	94.5	94.0	93.4	92.8	92.2
45	97.0	97.7	98.0	98.0	98.0	97.8	97.7	97.4	97.1	96.9	96.6	96.2	95.8	95.3	94.9	94.4	93.9	93.4	92.8	92.2
50	96.0	96.9	97.3	97.4	97.4	97.3	97.1	96.9	96.7	96.5	96.3	95.9	95.5	95.1	94.7	94.3	93.8	93.3	92.8	92.2
55	94.9	96.0	96.4	96.6	96.7	96.7	96.6	96.4	96.3	96.1	95.9	95.6	95.3	94.9	94.5	94.1	93.7	93.2	92.7	92.2
60	93.9	95.0	95.5	95.8	96.0	96.0	96.0	95.9	95.8	95.7	95.5	95.2	94.9	94.6	94.3	93.9	93.5	93.1	92.7	92.2
65	92.8	94.0	94.6	95.0	95.2	95.3	95.4	95.4	95.3	95.2	95.0	94.8	94.6	94.3	94.0	93.7	93.4	93.0	92.6	92.2
70	91.9	93.0	93.7	94.1	94.4	94.6	94.8	94.8	94.8	94.7	94.6	94.4	94.2	94.0	93.8	93.5	93.2	92.9	92.6	92.2
75	91.1	92.2	92.9	93.4	93.7	94.0	94.1	94.2	94.2	94.1	94.1	94.0	93.8	93.6	93.5	93.3	93.0	92.8	92.5	92.2
80	90.6	91.5	92.2	92.7	93.0	93.3	93.4	93.5	93.5	93.6	93.5	93.4	93.4	93.3	93.2	93.0	92.8	92.6	92.4	92.2
85	90.5	91.2	91.7	92.0	92.3	92.5	92.7	92.8	92.9	92.9	92.9	92.9	92.9	92.9	92.8	92.7	92.6	92.5	92.4	92.2
90	90.5	90.9	91.2	91.5	91.7	91.9	92.0	92.1	92.2	92.3	92.4	92.4	92.4	92.4	92.4	92.4	92.4	92.3	92.3	92.2
95	90.7	90.9	91.1	91.2	91.4	91.5	91.6	91.7	91.8	91.9	92.0	92.0	92.1	92.1	92.1	92.2	92.2	92.2	92.2	92.2
98	91.6	91.6	91.7	91.7	91.8	91.8	91.8	91.9	91.9	92.0	92.0	92.0	92.1	92.1	92.1	92.1	92.2	92.2	92.2	92.2

Mean Annual Mass Removal Efficiencies for 3.50-inches of Retention for Zone 5

NDCIA CN	Percent DCIA																			
	5	10	15	20	25	30	35	40	45	50	55	60	65	70	75	80	85	90	95	100
30	99.5	99.6	99.6	99.5	99.4	99.3	99.1	98.9	98.5	98.2	97.8	97.4	96.9	96.5	96.0	95.4	94.9	94.4	93.8	93.2
35	98.9	99.2	99.2	99.2	99.1	99.0	98.8	98.6	98.3	97.9	97.6	97.2	96.8	96.3	95.8	95.4	94.9	94.3	93.8	93.2
40	98.3	98.7	98.8	98.8	98.8	98.7	98.5	98.2	97.9	97.6	97.3	97.0	96.6	96.2	95.7	95.3	94.8	94.3	93.8	93.2
45	97.5	98.1	98.3	98.4	98.3	98.2	98.0	97.8	97.6	97.3	97.1	96.8	96.4	96.0	95.6	95.1	94.7	94.2	93.7	93.2
50	96.6	97.4	97.7	97.8	97.8	97.7	97.6	97.4	97.2	97.0	96.7	96.5	96.1	95.8	95.4	95.0	94.6	94.2	93.7	93.2
55	95.7	96.6	97.0	97.2	97.2	97.2	97.1	96.9	96.8	96.6	96.4	96.2	95.9	95.6	95.2	94.9	94.5	94.1	93.7	93.2
60	94.8	95.8	96.2	96.4	96.5	96.5	96.5	96.4	96.3	96.2	96.1	95.9	95.6	95.3	95.0	94.7	94.4	94.0	93.6	93.2
65	93.8	94.8	95.4	95.7	95.8	95.9	95.9	95.9	95.9	95.8	95.7	95.5	95.3	95.1	94.8	94.5	94.2	93.9	93.6	93.2
70	93.0	94.0	94.5	94.9	95.1	95.3	95.4	95.4	95.4	95.4	95.3	95.1	95.0	94.8	94.5	94.3	94.1	93.8	93.5	93.2
75	92.2	93.1	93.7	94.1	94.4	94.7	94.8	94.9	94.9	94.9	94.8	94.7	94.6	94.4	94.3	94.1	93.9	93.7	93.5	93.2
80	91.7	92.5	93.1	93.5	93.8	94.1	94.2	94.3	94.3	94.3	94.3	94.3	94.2	94.1	94.0	93.9	93.7	93.6	93.4	93.2
85	91.5	92.1	92.6	93.0	93.2	93.4	93.6	93.7	93.7	93.8	93.8	93.8	93.8	93.7	93.7	93.6	93.6	93.5	93.3	93.2
90	91.6	91.9	92.2	92.5	92.7	92.9	93.0	93.1	93.2	93.2	93.3	93.3	93.4	93.4	93.4	93.4	93.4	93.3	93.3	93.2
95	91.9	92.0	92.2	92.3	92.4	92.5	92.6	92.7	92.8	92.9	92.9	93.0	93.1	93.1	93.1	93.2	93.2	93.2	93.2	93.2
98	92.6	92.6	92.7	92.7	92.8	92.8	92.9	92.9	92.9	93.0	93.0	93.0	93.1	93.1	93.1	93.1	93.2	93.2	93.2	93.2

Mean Annual Mass Removal Efficiencies for 3.75-inches of Retention for Zone 5

NDCIA CN	Percent DCIA																			
	5	10	15	20	25	30	35	40	45	50	55	60	65	70	75	80	85	90	95	100
30	99.7	99.7	99.7	99.6	99.5	99.4	99.3	99.1	98.8	98.5	98.2	97.8	97.4	97.0	96.5	96.1	95.6	95.1	94.6	94.1
35	99.1	99.3	99.4	99.3	99.3	99.2	99.0	98.8	98.6	98.3	98.0	97.6	97.3	96.9	96.4	96.0	95.5	95.1	94.6	94.1
40	98.6	98.9	99.0	99.0	99.0	98.9	98.7	98.5	98.3	98.0	97.7	97.4	97.1	96.7	96.3	95.9	95.4	95.0	94.5	94.1
45	97.9	98.4	98.6	98.6	98.6	98.5	98.4	98.2	98.0	97.7	97.5	97.2	96.9	96.5	96.2	95.8	95.4	95.0	94.5	94.1
50	97.1	97.8	98.1	98.2	98.2	98.1	98.0	97.8	97.6	97.4	97.2	96.9	96.7	96.4	96.0	95.7	95.3	94.9	94.5	94.1
55	96.4	97.1	97.5	97.6	97.6	97.6	97.5	97.4	97.2	97.0	96.9	96.7	96.4	96.2	95.9	95.5	95.2	94.8	94.5	94.1
60	95.5	96.4	96.8	96.9	97.0	97.0	97.0	96.9	96.8	96.7	96.6	96.4	96.2	95.9	95.7	95.4	95.1	94.7	94.4	94.1
65	94.7	95.5	96.0	96.3	96.4	96.5	96.4	96.4	96.4	96.3	96.2	96.1	95.9	95.7	95.5	95.2	94.9	94.7	94.4	94.1
70	93.9	94.7	95.3	95.5	95.7	95.8	95.9	95.9	95.9	95.9	95.9	95.7	95.6	95.4	95.2	95.0	94.8	94.6	94.3	94.1
75	93.2	94.0	94.5	94.8	95.1	95.2	95.4	95.5	95.5	95.5	95.4	95.4	95.3	95.1	95.0	94.8	94.7	94.5	94.3	94.1
80	92.6	93.3	93.8	94.2	94.5	94.7	94.9	95.0	95.0	95.0	95.0	94.9	94.9	94.8	94.7	94.6	94.5	94.4	94.2	94.1
85	92.5	93.0	93.4	93.8	94.0	94.2	94.3	94.4	94.5	94.5	94.5	94.6	94.5	94.5	94.4	94.4	94.3	94.3	94.2	94.1
90	92.6	92.9	93.1	93.3	93.5	93.7	93.8	93.9	94.0	94.1	94.1	94.1	94.2	94.2	94.2	94.2	94.2	94.1	94.1	94.1
95	92.9	93.0	93.1	93.2	93.3	93.4	93.5	93.6	93.7	93.7	93.8	93.8	93.9	93.9	94.0	94.0	94.0	94.0	94.0	94.1
98	93.5	93.5	93.6	93.6	93.6	93.7	93.7	93.8	93.8	93.8	93.9	93.9	93.9	93.9	94.0	94.0	94.0	94.0	94.0	94.1

Mean Annual Mass Removal Efficiencies for 4.00-inches of Retention for Zone 5

NDCIA CN	Percent DCIA																			
	5	10	15	20	25	30	35	40	45	50	55	60	65	70	75	80	85	90	95	100
30	99.8	99.8	99.7	99.7	99.6	99.5	99.4	99.2	99.0	98.8	98.5	98.1	97.8	97.4	97.0	96.6	96.2	95.7	95.2	94.8
35	99.3	99.5	99.5	99.5	99.4	99.3	99.2	99.0	98.8	98.6	98.3	98.0	97.7	97.3	96.9	96.5	96.1	95.7	95.2	94.8
40	98.8	99.1	99.2	99.2	99.1	99.1	99.0	98.8	98.6	98.3	98.1	97.8	97.5	97.2	96.8	96.4	96.0	95.6	95.2	94.8
45	98.3	98.6	98.8	98.8	98.8	98.8	98.6	98.5	98.3	98.1	97.8	97.6	97.3	97.0	96.7	96.3	96.0	95.6	95.2	94.8
50	97.6	98.1	98.4	98.4	98.5	98.4	98.3	98.1	98.0	97.8	97.5	97.3	97.1	96.8	96.5	96.2	95.9	95.5	95.1	94.8
55	96.9	97.6	97.8	98.0	98.0	97.9	97.9	97.7	97.6	97.4	97.3	97.1	96.9	96.7	96.4	96.1	95.8	95.4	95.1	94.8
60	96.2	96.9	97.2	97.4	97.5	97.5	97.4	97.3	97.2	97.1	97.0	96.8	96.7	96.4	96.2	96.0	95.7	95.4	95.1	94.8
65	95.5	96.2	96.6	96.8	96.9	96.9	96.9	96.9	96.8	96.8	96.7	96.6	96.4	96.2	96.0	95.8	95.6	95.3	95.0	94.8
70	94.7	95.4	95.9	96.2	96.3	96.4	96.4	96.4	96.4	96.4	96.3	96.3	96.1	96.0	95.8	95.6	95.4	95.2	95.0	94.8
75	94.1	94.8	95.2	95.5	95.7	95.8	95.9	96.0	96.0	96.0	96.0	95.9	95.8	95.7	95.6	95.5	95.3	95.1	95.0	94.8
80	93.5	94.1	94.5	94.9	95.1	95.3	95.4	95.5	95.6	95.6	95.6	95.6	95.5	95.4	95.3	95.3	95.1	95.0	94.9	94.8
85	93.3	93.8	94.1	94.4	94.7	94.8	95.0	95.1	95.1	95.2	95.2	95.2	95.2	95.2	95.1	95.1	95.0	94.9	94.9	94.8
90	93.4	93.7	93.9	94.1	94.3	94.4	94.5	94.6	94.7	94.8	94.8	94.8	94.8	94.9	94.9	94.9	94.8	94.8	94.8	94.8
95	93.7	93.8	93.9	94.0	94.1	94.2	94.3	94.3	94.4	94.5	94.5	94.6	94.6	94.6	94.7	94.7	94.7	94.7	94.8	94.8
98	94.2	94.3	94.3	94.3	94.4	94.4	94.4	94.5	94.5	94.5	94.6	94.6	94.6	94.6	94.7	94.7	94.7	94.7	94.8	94.8